

Protection of Civilians Military Reference Guide

Second Edition



U.S. Army Peacekeeping and Stability
Operations Institute



Protection of Civilians Military Reference Guide

Second Edition

Peacekeeping and Stability Operations Institute (PKSOI)

United States Army War College

Carlisle, Pennsylvania 17013

January 2018

Comments on the *Protection of Civilians Military Reference Guide* are invited and should be forwarded to: Director, Peacekeeping and Stability Operations Institute, U.S. Army War College, 22 Ashburn Drive, Carlisle, PA (USA) 17013-5054 (usarmy.carlisle.awc.list.pksoi-operations@mail.mil).

The *Protection of Civilians Military Reference Guide* is in the public domain and may be reproduced or modified as desired, provided that the document is appropriately cited. Suggested citation:

Peacekeeping and Stability Operations Institute. *Protection of Civilians Military Reference Guide* (second edition). Carlisle, PA: PKSOI, 2017.

The *Protection of Civilians Military Reference Guide* is an informal white paper that should not be interpreted as official doctrine or policy of any institution. The views expressed are those of the author and do not necessarily reflect the official policy or position of the Department of the Army, Department of Defense, or the U.S. Government.

All Peacekeeping and Stability Operations Institute (PKSOI) publications are available on the PKSOI homepage for electronic dissemination. PKSOI's homepage address is: <http://pksoi.armywarcollege.edu>

PKSOI publishes a quarterly journal to update the peace and stability operations community on the research of our analysts, recent and forthcoming publications and upcoming conferences sponsored by PKSOI. Each quarterly journal has a specific theme related to peace and stability operations and a commentary by the Director of PKSOI entitled The Director's Corner. If you are interested in receiving this journal, please subscribe on the PKSOI homepage at <http://pksoi.armywarcollege.edu>

Protection of Civilians Military Reference Guide

Table of Contents

Preface	v
Executive Summary	vii
Chapter 1: Introduction to the Protection of Civilians	1
Background, Purpose, and Scope	1
Protection of Civilians Overview	3
PoC and the Military Force	5
The 3-45 PoC Framework	8
Chapter 2: Understand Civilian Risks	13
Task 1: Understand the Operational Environment	14
Task 2: Understand the Actors	20
Task 3: Understand the Dynamics	29
Task 4: Understand Civilian Vulnerabilities and Threats	32
Task 5: Understand the PoC Strategy	41
Task 6: Conduct Intelligence Activities	42
Task 7: Manage Multi-Source Information	47
Task 8: Conduct Assessments	48
Chapter 3: Protect Civilians During Operations	55
Task 9: Plan for the Protection of Civilians	56
Task 10: Prepare for the Protection of Civilians	62
Task 11: Conduct Patrols	67
Task 12: Establish Checkpoints, Guard Posts, and Observation Posts	72
Task 13: Conduct Cordon and Search Operations	75
Task 14: Neutralize or Defeat Perpetrators	77
Task 15: Secure Vulnerable Civilians	80
Task 16: Evacuate Vulnerable Civilians	82
Task 17: Conduct Interposition Operations	84
Task 18: Mitigate Civilian Casualties	86
Task 19: Respond to Reported Incidents of Civilian Harm	87
Task 20: Protect the Force	89
Task 21: Provide Command and Control	90
Task 22: Provide Administration and Logistics	92
Task 23: Integrate Fire Support	94
Task 24: Support the Protection of Children	95
Task 25: Support the Elimination of Conflict-Related Sexual Violence	98
Task 26: Conduct Combined Operations	103
Task 27: Support Relief for Displaced Persons	104
Task 28: Support Humanitarian Assistance	108
Task 29: Contain Public Unrest	114

Chapter 4: Shape a Protective Environment	117
Task 30: Manage Expectations	118
Task 31: Conduct Information Activities.....	120
Task 32: Conduct Engagements with Key Leaders and the Population	123
Task 33: Support the Political Settlement.....	126
Task 34: Coordinate with Other Actors	127
Task 35: Build Partner Capacity	131
Task 36: Establish and Maintain a Safe and Secure Environment.....	133
Task 37: Support Good Governance.....	138
Task 38: Support the Rule of Law	140
Task 39: Support Social Well-Being	142
Task 40: Support a Sustainable Economy.....	144
Task 41: Maintain PoC During Transitions	145
Task 42: Support Security Sector Reform	149
Task 43: Support Disarmament, Demobilization, and Reintegration	151
Task 44: Support Transitional Justice.....	153
Task 45: Support Community Building	155
Chapter 5: Tradeoffs, Challenges, and Risks	157
Tradeoffs	157
Challenges.....	159
Risks.....	161
Conclusion	164
Annexes	165
Annex A. Protection of Civilians Task List.....	167
Annex B. The United Nations and PoC	169
Annex C. NATO and PoC	173
Annex D: PoC Training Curricula	175
Annex E: PoC Training Scenarios	180
Annex F: Legal Considerations.....	215
Annex G. Planning Templates	222
Annex H: Acronyms	242
Annex I. Glossary	243
Annex J. Selected References	245
About the PoC Military Reference Guide.....	249
Acknowledgements.....	249

Preface

The *Protection of Civilians (PoC) Military Reference Guide* is a revision of the 2013 version published by the U.S. Army Peacekeeping and Stability Operations Institute. This version incorporates a modified framework and task set to be compatible with the “Understand-Shape-Protect” approach in recent U.S. military doctrine on PoC. The revision adds annexes on UN and NATO approaches to PoC and provides suggestions for adapting the guide to these contexts. Other new annexes provide suggestions for conducting training on PoC to include an extensive annex with training scenarios. This version also has general updating of the entire content; for example, the discussion of civilian risks in Chapter 2 has been completely revised.

The *PoC Military Reference Guide* is primarily intended for military commanders and staffs who must consider PoC during armed conflict, multidimensional peace operations, or other military operations, particularly when PoC is an operational or strategic objective. It is designed as a supplement to existing doctrine and other relevant guidance so that military forces can meet their obligations to protect civilians. The reference guide may also be used as a textbook for PoC training.

Other potential audiences are international organizations (such as the United Nations, African Union, and NATO), national militaries, and training centers. While this document is not meant to usurp processes that these institutions are undertaking to create their own internal guidance, the *PoC Military Reference Guide* can support doctrine development and training in global military institutions. Users are encouraged to adapt it to their needs as appropriate.

Although the *PoC Military Reference Guide* focuses primarily on the military aspects of PoC, it recognizes that any military force will likely be one element of a larger multidimensional international mission that includes civilian and police components as well. Accordingly, the *PoC Military Reference Guide* may also be a useful resource for nonmilitary PoC actors.

Readers should bear in mind that the *PoC Military Reference Guide* cannot serve as a perfect template of solutions for PoC training, planning, and operations. Rather, it is a general approach that should be tailored for particular circumstances.

Protection of Civilians Military Reference Guide

Second Edition

Executive Summary

Protection of Civilians (PoC) must be considered and integrated during all military operations, including peace operations and operations during armed conflicts. Civilians are protected persons under international law, and parties to a conflict have a legal obligation to protect civilians from the conflict's effects. Additionally, PoC is a major objective of many military operations and is frequently included in mandates for peace operations.

There is often a lack of clarity and common understanding about PoC and how to achieve it. Many recent studies have noted that civilians are the people most at risk during armed conflict, and peacekeeping operations have faced significant challenges in protecting civilian populations effectively. These studies have identified numerous problems including inadequate mandates; a lack of applicable doctrine; differing views on what PoC includes; challenges in integrating the diverse set of military, police, and civilian actors required for PoC; a lack of the necessary capabilities; uncertainty regarding when force should be used to protect civilians; and how to protect civilians when the host state is the perpetrator of violence.

This *PoC Military Reference Guide* is intended to be a resource for military commanders and staffs who must consider PoC across the spectrum of military operations. Other interested readers may include international organizations, national militaries, training centers, and civilian and police officials who are also concerned with PoC.

Chapter 1 provides an introduction to PoC and presents the PoC framework used in the document, and notes that military forces support PoC in two general ways:

- **Avoidance of Civilian Harm.** Military forces act in accordance with the law of armed conflict—also known as international humanitarian law (LOAC/IHL) and other relevant bodies of law to minimize civilian harm. Additionally, military forces avoid actions that undermine efforts by other actors that improve human security.
- **Deliberate PoC Actions.** Military forces conduct offensive, defensive, and stability activities expressly intended to mitigate harm to civilians, including operations intended to create an environment conducive to PoC.

In this reference guide, PoC is defined as “**efforts to reduce civilian risks from physical violence, secure their rights to access essential services and resources, and contribute to a secure, stable, and just environment for civilians over the long-term.**” PoC is a moral, political, legal, and strategic priority for all military operations. Communities on the ground and around the world expect uniformed personnel to protect the population; failure to do so jeopardizes the credibility and legitimacy of the operation and can undermine other objectives. PoC has military and nonmilitary aspects and may be viewed as a layered set of issues, including physical protection from imminent violence, the provision of basic necessities, protection of human rights, and broader

enabling conditions. Military forces may play a partial role in guaranteeing PoC; in many cases, they will support police and civilian organizations that must ultimately ensure that PoC is effective and lasting.

The reference guide incorporates a “3-45 PoC Framework” which includes three fundamentals to guide military forces during their operations and 45 PoC-related tasks that military forces may perform:

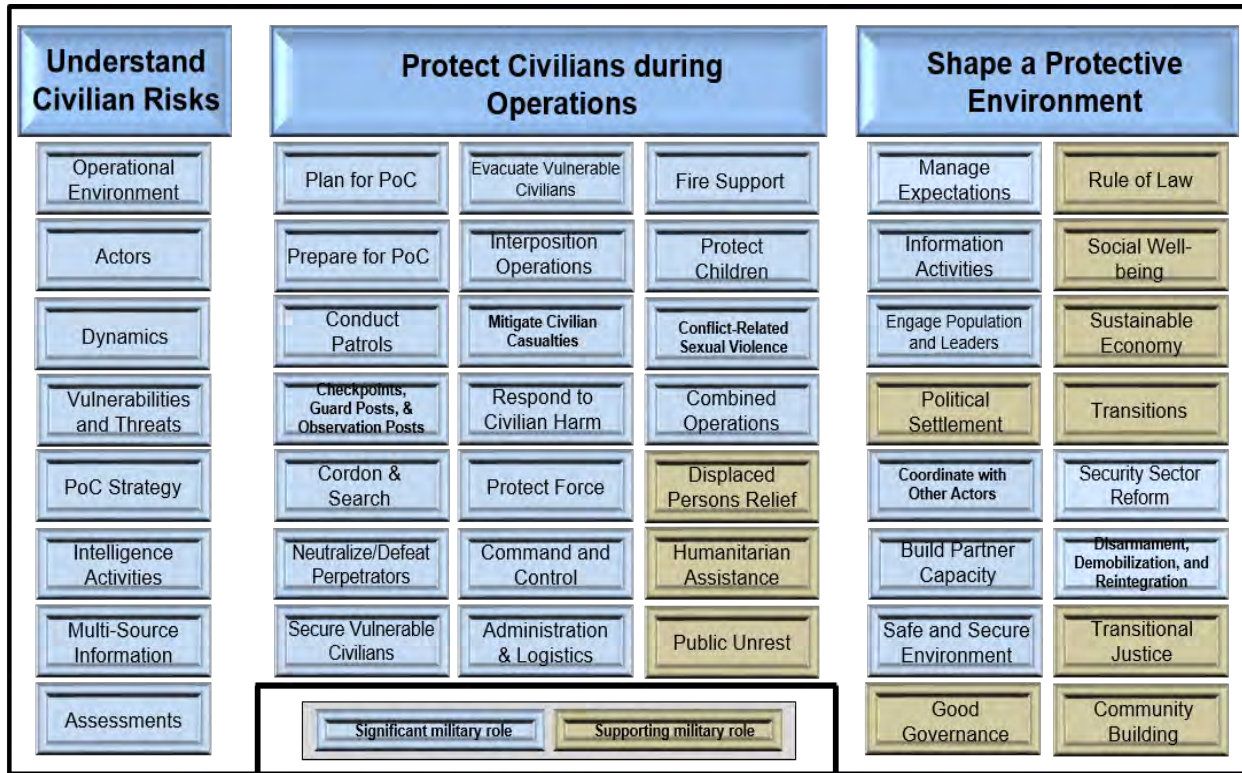

► The 3-45 PoC Framework ◀

- **Fundamental #1: Understand Civilian Risks.** Military forces must have an understanding of the operational environment, the significant actors, civilian vulnerabilities and threats to civilians, and dynamics. Military forces must collect and manage information from a variety of sources, share relevant information, and conduct accurate assessments. Chapter 2 discusses the civilian risk variables in the following graphic and also addresses the tasks that support this PoC fundamental.

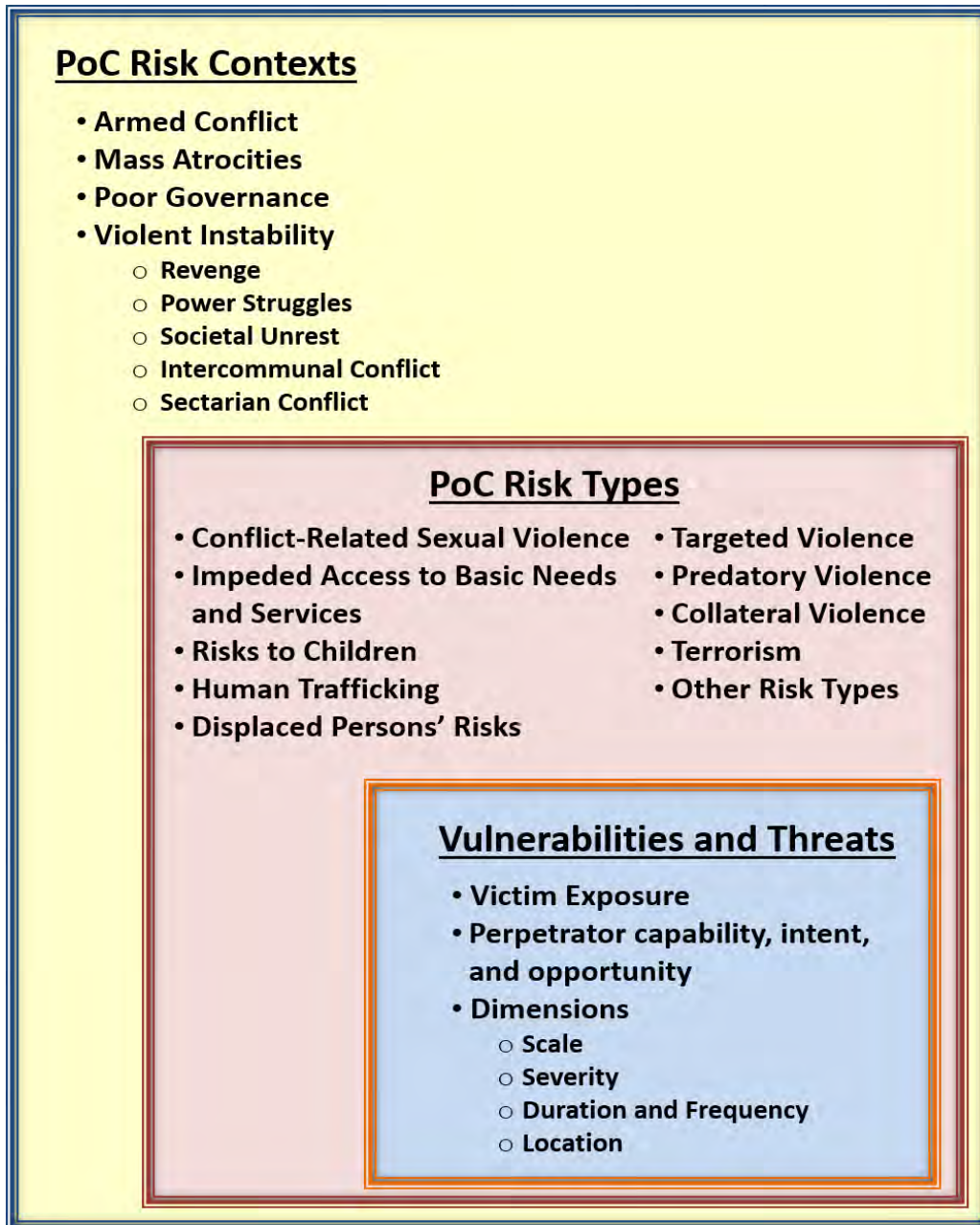

► **Civilian Risk Variables** ◀

- **Fundamental #2: Protect Civilians during Operations.** In some situations, military forces plan, prepare, and conduct operations specifically to protect civilians. In others, they support the protection of civilians with offensive, defensive, and stability activities that may primarily be conducted for other purposes besides civilian protection. The military force may employ a combination of seven different PoC operational approaches, including Area Security, Clear-Hold-Build, Separation, Safe Areas, Partner Enabling, Containment, and Defeat Adversaries. Routine military functions such as command and control, patrolling, logistics, and force protection can all have a significant impact upon the protection of civilians. It is important for military forces to “mainstream” PoC

considerations into their planning and operations and to anticipate unintended consequences. These and other related tasks are discussed in Chapter 3.

- **Fundamental #3: Shape a Protective Environment.** PoC requires more than the effective performance of military tasks that protect civilians in the short term. Lasting PoC also depends on the creation of a surrounding environment that supports civilian well-being, addresses the root causes of conflict, and mitigates grievances that could generate renewed fighting which threatens civilians. Nonmilitary actors will often have primary responsibility and capability for many of the tasks that support a protective environment, such as fostering good governance, the rule of law, social well-being, and a sustainable economy. Military forces may support these efforts by contributing to a safe and secure environment that provides sufficient “space” for other actors. Military forces must coordinate effectively with these other actors, key leaders, and the local population, with information activities that support these efforts and advance the protection of civilians. Military forces may also be involved in essential programs such as security sector reform (SSR), disarmament, demobilization, and reintegration (DDR), and other capacity-building efforts to build host-state capacity and improve the environment so that lasting PoC can be achieved.

In Chapters 2 through 4, the *PoC Military Reference Guide* discusses 45 relevant tasks that support the three overarching PoC fundamentals. When conducting an operation in which PoC is a major consideration, commanders should analyze whether the tasks are applicable to the situation and, if so, whether they are being addressed adequately. Military forces play a major role in most of the tasks. For some critical PoC tasks, however, the military will likely act in a supporting role to other actors. Each of the 45 tasks in the *PoC Military Reference Guide* includes a discussion of the following elements:

- Task Description.
- Task Relevance to PoC.
- How the Task is Accomplished.
- Task Challenges.

While many of the 45 tasks are not limited to PoC situations, insufficient attention to any of them could result in a failure to protect civilians effectively. The nature and relevance of a particular task will depend on the context and objectives of the mission (for example, whether the military is engaged in armed conflict or peace operations). The military may, at most, play a marginal or supporting role for eleven of the tasks, such as those related to governance, rule of law, social well-being, and humanitarian assistance (although in extreme situations the military may be a provider of “last resort”). In many situations, the military can assist nonmilitary efforts in these areas; in any case, the military must be aware that such tasks are often critical and ensure that units avoid undermining these efforts. The 45 tasks are largely mutually supporting, in that success (or setbacks) in one task can have an effect on other tasks as well. Commanders and staffs should carefully analyze the tasks for applicability to their particular situations; it may be appropriate to refine some tasks, delete some, or add others.

Chapter 5 concludes with a discussion of the significant PoC tradeoffs, challenges, and risks that military leaders are likely to confront. Some of these tradeoffs include the roles of host-state

and external actors, PoC and the pursuit of other military objectives, short-term and long-term goals, and mandate interpretation as compared with the needs on the ground. Chapter 5 addresses likely challenges including corruption, constraints on the military force, resource limitations, and the ability to achieve unity of effort. The chapter also discusses civilian risks and other mission risks.

The annexes include supplemental information such as discussions on PoC and the UN and NATO, suggestions for PoC training and scenarios, legal considerations, and planning templates.

Too often in the past, military forces have inadequately protected civilians for a variety of reasons, or have themselves posed threats to civilians. Units conducting peace operations or engaged in armed conflict must be much more effective at protecting civilians in the future. As discussed in the *PoC Military Reference Guide*, the military's contribution to PoC rests upon the ability to execute numerous tasks effectively. Units must integrate their efforts with nonmilitary actors, often in a supporting role, and operate while contending with tradeoffs, challenges, and risks that make PoC a complex endeavor under the best of circumstances. This requires forces that are well-trained, disciplined, properly equipped, and agile. They must be present in adequate strength with appropriate capabilities, have a demonstrable grasp of the situation, and be able to synchronize effective PoC efforts. Units must be committed to PoC and must have leaders who have a sophisticated understanding of PoC considerations, cooperate effectively with other contributors, and act decisively when necessary.

Chapter 1

Introduction to the Protection of Civilians

- Background, Purpose, and Scope
- Protection of Civilians (PoC) Overview
- PoC Risks
- PoC and the Military Force
- The 3-45 PoC Framework

BACKGROUND, PURPOSE, and SCOPE

BACKGROUND

a. Protection of Civilians (PoC) must be considered and integrated during all military operations, including peace operations and during armed conflict. Regardless of the operation's primary purpose, PoC is important for moral, political, legal, and military reasons. According to the law of armed conflict (LOAC), also known as international humanitarian law (IHL) or the law of war, civilians and all persons not taking part in combat may not be the object of attacks and must be spared and protected. However, during contemporary operations military actors often must strive for more than the mere compliance with LOAC/IHL.

b. For military forces, the population's support is often the center of gravity and indispensable for mission accomplishment. The political goals and objectives of a peace operation, combat operation, or any other operation with a military component often include security, stability, a sustainable peace, or other conditions that are better than the status quo. Civilians living within a highly insecure environment expect the operation, and particularly uniformed military personnel, to provide security. Moreover, observers around the world with easy access to media also expect the military force to protect civilians. The credibility and legitimacy of a military operation and the overarching political mission or goal depend on military actors who are willing and able to proactively protect civilians from other threats.

c. PoC is relevant in the contexts of both peace and combat operations. Since 1999, fourteen UN multidimensional peacekeeping operations have been authorized to use force to protect civilians,¹ and the vast majority of UN troops currently deployed are serving in missions with such mandates.² In addition, multinational operations in East Timor, Iraq, Somalia, Afghanistan, Libya, and elsewhere have often confronted PoC situations including widespread and systematic abuses against civilian populations. In some cases, PoC has been the primary purpose of the operation and

¹ MINURCAT (Central African Republic and Chad); MINUSTAH (Haiti); MONUC/MONUSCO (Democratic Republic of the Congo); ONUB (Burundi); UNAMID (Darfur); UNAMSIL (Sierra Leone); UNIFIL (Lebanon); UNISFA (Abyei); UNMIL (Liberia); UNMIS (Sudan); UNMISS (South Sudan); UNOCI (Cote d'Ivoire), MINUSMA (Mali), and MINUSCA (Central African Republic). The UN Security Council has also authorized missions led by other multilateral bodies to protect civilians.

² Peacekeeping missions operate in accordance with three principles: consent of the parties, impartiality, and non-use of force except in self-defense or in defense of the mandate, including PoC when incorporated in the mandate.

the dominant military consideration. Despite the recognition of PoC's importance in peace and combat operations, policymakers and military practitioners have struggled with how to apply military force and integrate it with broader efforts to protect vulnerable civilians in hostile environments.

d. A number of prominent studies have highlighted the need for applicable PoC doctrine.³ Comprising “fundamental principles by which the military forces guide their actions in support of objectives,”⁴ doctrine is essential for military operations and also drives institutional functions such as organization, training, materiel acquisition, and leader development. Recently developed doctrine within national militaries and multilateral institutions often includes civilian security either as a major operational consideration or as an objective that contributes to mission accomplishment.⁵ However, there are still few examples of official military doctrine regarding PoC.⁶

PURPOSE

a. The *PoC Military Reference Guide* is intended to help military commanders and staffs integrate PoC into their missions at the operational and tactical levels. It is meant to be generally applicable across a wide spectrum of military efforts from peace operations to armed conflict. However, the reference guide is not meant to be a complete operational checklist, and it must be adapted to the reader's context.

b. Other intended audiences include international organizations that conduct military missions, national militaries, and military training centers. Many of these institutions are refining their mission strategies, doctrine, and concepts regarding PoC. The *PoC Military Reference Guide* is not meant to usurp the internal processes of such organizations; rather, it is intended to assist their doctrine development, training, planning, and operations as they deem appropriate.

SCOPE

a. The *PoC Military Reference Guide* provides a framework of 45 PoC-related tasks, which are grouped under three principles. The “3-45 Framework” is discussed within two main contexts for military forces:

(1) **Peace Operations** includes conflict prevention, peacemaking, peacekeeping, peace enforcement, and peace building. The military is ideally an impartial actor present with the consent of the host state, although this may not be the case during peace enforcement operations.

³ See, for example, Alison Giffen, *Addressing the Doctrinal Deficit: Developing Guidance to Prevent and Respond to Widespread or Systematic Attacks Against Civilians* (Washington, DC: The Stimson Center, Spring 2010).

⁴ North Atlantic Treaty Organization, *NATO Glossary of Terms and Definitions* (AAP-6) (Brussels: North Atlantic Treaty Organization, 2010).

⁵ For example, see contemporary doctrinal publications on stabilization, counterinsurgency, and peace operations from the United Kingdom, the United States, the African Union, and NATO. Also see United Nations, *UN Peacekeeping Operations Principles and Guidelines* (also known as the “UN Capstone Doctrine”) (New York: Department of Peacekeeping Operations and Department of Field Support, 2008).

⁶ For a current example, see U.S. Army Techniques Publication ATP 3-07.6 *Protection of Civilians* (Washington, DC: Headquarters, Department of the Army, October 2015).

(2) **Armed Conflict** includes combat situations in which the military is a party to the conflict. This may include limited interventions, counterinsurgency, irregular warfare, or major combat operations.

b. Many of the tasks and principles apply to all military operations and are not unique to PoC situations. Some tasks have more or less applicability depending upon whether the context is peace operations or armed conflict. Although the military usually has a limited role in at least 12 of the tasks in the *PoC Military Reference Guide*, they are included because PoC could be jeopardized due to shortfalls in any of these tasks.

c. Users should modify the 45 tasks as appropriate to their circumstances, and otherwise tailor the *PoC Military Reference Guide* while working with, supporting, and enabling other actors to establish an environment in which civilians are protected. For example, an operation of limited duration may not have to address some of the tasks related to long-term goals such as supporting good governance. While designed to inform military efforts related to PoC, the *Military Reference Guide* cannot simply be a methodological substitute for adaptive units, a command climate that emphasizes the importance of PoC, and leaders who can make timely and appropriate decisions based upon critical situations on the ground.

d. Finally, while the *PoC Military Reference Guide* focuses on the military aspects of PoC, it emphasizes that any military force will likely be one component of a larger multidimensional mission that includes civilian and police components. In many cases, the military will support and enable nonmilitary actors whose activities ultimately are the most significant for ensuring PoC in the long term. Although primarily intended for military readers, the *PoC Military Reference Guide* may also inform the PoC efforts of these nonmilitary actors.

POC OVERVIEW

Under LOAC/IHL, a civilian is a person who is not a member of his or her country's armed forces or other militia. Civilians are afforded legal protection from the effects of war and military occupation. PoC is a significant consideration during armed conflict for two reasons. First, civilians are distinct from combatants and by international law must be afforded protection from the effects of war and military occupation. Second, PoC can be a prominent objective of a military operation. PoC can also be a critical consideration during peace operations, especially when a mission's mandate includes PoC. Additionally, PoC can be a factor during other military activities when human security is at risk.

DEFINITION

a. While PoC has different interpretations among various actors, it is defined in the *PoC Military Reference Guide* as follows:

PoC consists of efforts to reduce civilian risks from physical violence, secure their rights to access essential services and resources, and contribute to a secure, stable, and just environment for civilians over the long-term.⁷

⁷ See Giffen, 14. Also see the International Committee of the Red Cross (ICRC), *Enhancing Protection for Civilians in Armed Conflict and Other Situations of Violence* (Geneva: ICRC, September 2008), 9. This document states: "For the

b. This definition is relevant during both peace and combat operations, and may also apply to other situations when military forces are used to address risks to civilians. This definition indicates that PoC has both military and nonmilitary aspects, and suggests that enduring PoC often requires more than a short-term focus on imminent threats of violence.

c. PoC involves a wide range of actors besides the military force. These include domestic and international civilian, police, and military organizations that address security, governance, rule of law, humanitarian, and developmental needs. The latter considerations are often relevant to provide for civilian well-being and mitigate grievances and root causes of conflict that can harm civilians. PoC actors may have dissimilar objectives and use different methods, even if they can agree about the general desirability of PoC. Actors are discussed in further detail in Chapter 2 of the *PoC Military Reference Guide*.

POC LAYERS

a. Observers and practitioners sometimes debate whether PoC efforts should strictly focus on protection from threats of physical violence, or whether they should encompass a broader human security agenda including human rights. In this reference guide, PoC is viewed as a layered set of issues, broadly categorized as shown in Figure 1.1.

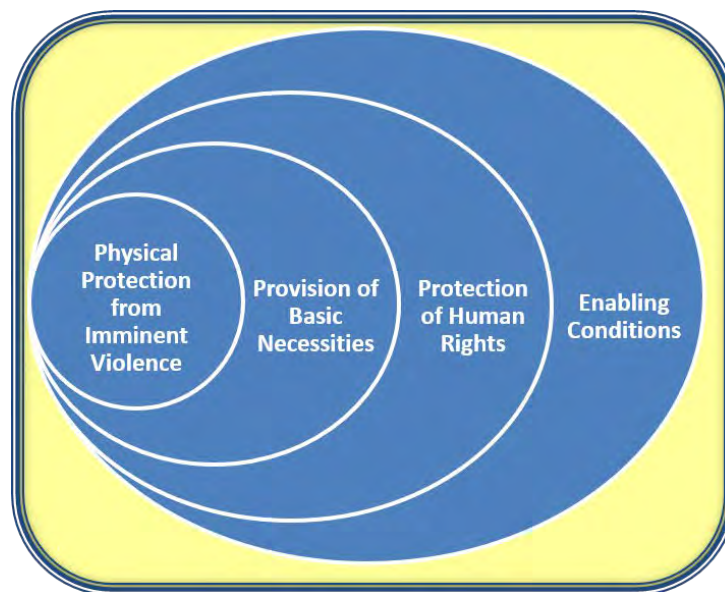

► Figure 1.1: PoC Layers⁸ ◀

ICRC, protection, in the broadest sense, aims to ensure that authorities and other actors respect their obligations and the rights of individuals in order to preserve the lives, security, physical and moral integrity and dignity of those affected by armed conflicts and/or other situations of violence. Protection includes efforts that strive to prevent or put a stop to actual or potential violations of international humanitarian law (IHL) and other relevant bodies of law or norms that protect human beings. Above all, protection aims to eradicate the causes of violations, or the circumstances that lead to them, by addressing mainly those responsible for the violations and those who may have influence over them.”

⁸ Paul Williams, *Enhancing Civilian Protection in Peace Operations: Insights from Africa* (Washington DC: National Defense University Press, 2010), 16. Titled “The Civilian Protection ‘Onion’” in original.

POC RISKS

a. **PoC Risk Contexts.** PoC is a major concern in four general risk contexts that are not mutually exclusive. The first is **armed conflict** including war between nation states and internal civil wars, insurgencies, and counterinsurgencies. The second risk context is **mass atrocities**, or widespread and often systematic acts of violence against civilians by state or non-state armed groups, including killing, causing serious bodily or mental harm, or deliberately inflicting conditions of life that cause serious bodily or mental harm. The third PoC risk context is **poor governance** resulting in large-scale violations of civilian physical well-being and human rights. Finally, a fourth context is **violent instability** manifested by revenge, power struggles, widespread unrest, intercommunal conflict, or sectarian conflict.

b. **PoC Risk Types.** Certain types of PoC risks commonly occur in the different contexts. These include sexual and gender-based violence, impeded access to basic needs and services, risks to children, human trafficking, risks to displaced persons, targeted violence, predatory violence, collateral violence, terrorism, and other risk types.⁹

c. PoC Risks are discussed further in Chapter 2 under Task 4—*Understand Civilian Vulnerabilities and Threats*.

POC AND THE MILITARY FORCE

a. PoC is an important consideration across the spectrum of military operations shown in Figure 1-2. Whether the military force is an impartial actor (such as during peace operations) or a party to the conflict (such as during armed conflict, including counterinsurgency), leaders will likely have to address PoC. Depending upon the situation, PoC may be the primary purpose of a mission or one of a mission’s many supporting tasks or mandated objectives. Military forces must conduct operations in accordance with LOAC/IHL and, where applicable, international human rights law (IHRL).¹⁰

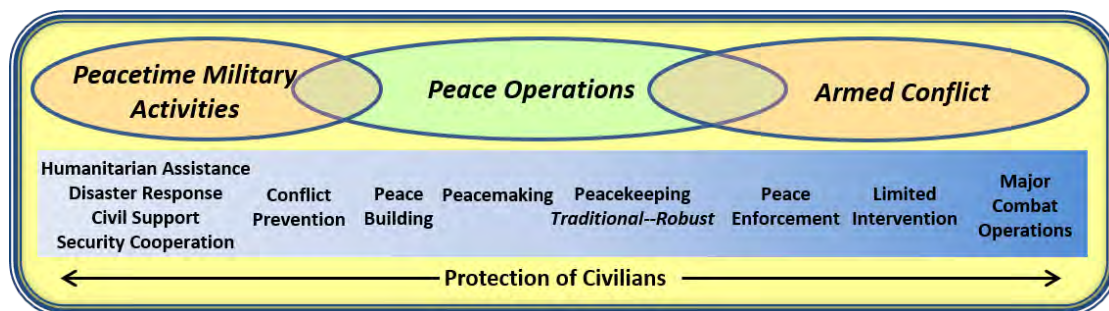

► Figure 1.2: Spectrum of Military Operations ◀

b. Military forces should consider PoC in three general contexts, the first of which is a range of domestic or international **peacetime military activities**. The second is **peace operations** in

⁹ Other risks include food and water insecurity, health impacts, economic impacts, societal impacts, environmental impacts, organized crime, corruption, property disputes, border tensions, and regional instability.

¹⁰ Some countries view IHRL as the applicable body of law for situations outside of armed conflict. Additionally, some countries interpret IHL as sufficient during armed conflict. See Annex F for a discussion of legal considerations.

which the military is normally an impartial actor, present with the consent of the host state and (ideally) the parties to a conflict, and is mandated to monitor compliance with appropriate resolutions and agreements, support reconciliation, or facilitate transition to legitimate governance. Mandates for peace operations often include a provision to protect civilians.¹¹ The third context is **armed conflict**, in which the military force is a party to the conflict and achieves a political objective coercively. During armed conflict, the primary responsibility for PoC lies with the parties to the conflict, first and foremost in accordance with their obligations under LOAC/IHL.¹² Some situations may incorporate features of peace operations as well as armed conflict. Potential operations along the spectrum include the following.¹³

PEACETIME MILITARY ACTIVITIES

These operations are normally not directly related to conflict and include the domestic or international employment of military forces. They may be under international authorization or based upon unilateral or bilateral decisions. While these activities often occur outside of a peace operations context, many PoC considerations are similar. Peacetime military activities include the following:

a. **Disaster Response or Relief of Acute Human Suffering.** Military forces may be deployed domestically or internationally, usually as a last resort when civilian capabilities are inadequate.

b. **Support to Civil Authorities.** Military forces may be employed domestically to address heightened security requirements during civil disturbances or significant public events, or to support endeavors such as crop harvesting.

c. **Security Cooperation.** Military forces may be employed internationally during peacetime to conduct exercises or provide security-related assistance. These activities may be conducted under international authorization or occur as a result of arrangements between the relevant countries.

¹¹ Typical PoC mandate language includes the following: “(Operation) is authorized to take the necessary action in the areas of deployment of its forces and as it deems within its capabilities and without prejudice to the responsibility of the Government of (*host state*), to protect civilians under imminent threat of physical violence.” See UN OCHA, *Aide Memoire For the Consideration of Issues Pertaining to the Protection of Civilians in Armed Conflict* (4th Edition) (New York: Office for the Coordinator of Humanitarian Affairs, 2011) and UN Security Council Resolution 1894 (2009) which is the benchmark resolution establishing the main elements. See also *Protection of Civilians: Implementing Guidelines for Military Components of United Nations Peacekeeping Missions* (New York: United Nations Department of Peacekeeping Operations and Department of Field Support, February 2015) which describes three PoC Tiers: (1) Protection through Dialogue and Engagement; (2) Provision of Physical Protection; and (3) Establishing a Protective Environment. The African Union (AU) has largely adopted this framework as well.

¹² The 4th Geneva Convention relative to the Protection of Civilian Persons in Time of War provides the legal basis for understanding PoC obligations of warring parties. These obligations include distinguishing at all times between civilians and combatants and between civilian objects and military objectives, and taking all feasible precautions to minimize injury to civilians, loss of civilian life, and damage to civilian objects. The International Committee of the Red Cross (ICRC) is an independent, neutral agency that serves as the guardian of IHL, promoting its implementation at the national level and in modern conflict. For more information on the protection mandate of the ICRC, see the ICRC Policy on Protection (2008).

¹³ Descriptions are in part adapted from the UN Capstone Doctrine and Allied Joint Publication (AJP 3.4.1) *Peace Support Operations* (Brussels: North Atlantic Treaty Organization, July 2001).

PEACE OPERATIONS

Peace operations (or peace support operations) prevent or contain conflict, restore peace, or support reconciliation and rebuilding in a post-conflict setting. There are five types of peace operations:

a. **Conflict Prevention.** Military activities may build capacity, mitigate undesired conditions, or deter a threat.

b. **Peace Building.** Military actors conduct stability activities (often referred to as “stability operations”), usually in conjunction with or in support of nonmilitary actors. These efforts often emphasize building or strengthening host-state institutions to prevent conflict.

c. **Peacemaking.** Military actors support diplomatic activities to establish a cease-fire or a rapid peaceful settlement of an existing or imminent conflict. Peacemaking measures include the provision of good offices, mediation, diplomatic pressure, isolation, or sanctions. Military support to peacemaking may include direct or indirect involvement of military assets (e.g., staff support, planning, providing security, or contributing military advice).

d. **Peacekeeping.** Military operations designed to preserve peace where fighting has halted, often to support implementation of cease-fire agreement or truce, and to support diplomatic efforts to reach a long-term political settlement.

(1) “Traditional” Peacekeeping—often mandated under Chapter VI of the UN Charter (Pacific Settlement of Disputes). Traditional peacekeeping occurs with the consent of all major parties to the conflict. While traditional peacekeepers may have a PoC mandate, the situation makes it unlikely that they will have to use force and their activities are normally limited to monitoring an agreement’s implementation.

(2) “Robust” Peacekeeping—often mandated under Chapter VII of the UN Charter (Action with Respect to Threats to the Peace, Breaches of the Peace, and Acts of Aggression). Robust peacekeeping may be required when some actors do not provide “tactical” consent to the mission. Peacekeepers may be required to use force on selected occasions for self-defense or defense of the mandate, including support of PoC. Peacekeepers may be involved in other tasks that support nation building.

e. **Peace Enforcement** involves the use or threat of military force, normally pursuant to international authorization in support of a mandate but without the consent of all parties to the conflict, to compel compliance with resolutions or sanctions designed to maintain or restore peace and order.

ARMED CONFLICT

a. “Armed conflict” is an imprecise and frequently-debated term, but it may be viewed as a condition that exists when a high level of violence occurs between organized armed factions including military forces, paramilitary forces, militias, rebel groups, or other armed actors. Armed conflicts may be international or intra-national.

(1) **Limited Intervention** includes the use of military force, often in a crisis situation, and generally is intended to be of limited scale and short duration. Coercive interventions may be conducted for objectives related to PoC, with or without the consent of the host state. An intervention could be an initial phase or an extension of major combat operations.

(2) **Major Combat Operations** usually entail an extended campaign and includes interstate conflict between traditional militaries as well as counterinsurgency. These conflicts often require an extensive stabilization and reconstruction effort.

b. In addition to overarching legal and moral PoC requirements, recent military experiences provide at least three significant reasons to support PoC. First, peace operations, stability efforts, and counterinsurgency experience and doctrine highlight that the population is often the center of gravity for military operations, and the population's support is, in part, related to the ability to provide protection from perpetrators or, in some cases, from rival identity groups. Second, civilian casualties can undermine military efforts and become a divisive issue between multinational partners. Even if a military force is itself not directly responsible for civilian casualties that occur, there are likely to be expectations that the force should be able to prevent widespread harm to civilians, regardless of the cause.

c. Finally, during peace operations and armed conflict military forces are to varying degrees concerned with civilian welfare as they support efforts to shape a protective environment, as discussed in Chapter 4. These longer-term efforts can contribute to the protection of civilians from future threats, including those that are not necessarily related to violence. Under certain circumstances, addressing other urgent human security¹⁴ threats could be the main operational focus of military forces as they support other actors. Additionally, it may be unlikely that a peaceful political settlement can be achieved unless nonmilitary considerations are adequately addressed.

MILITARY POC ROLES

Whether engaged in peace or combat operations, military forces support PoC in two general ways:

a. **Avoidance of Civilian Harm.** Military forces act in accordance with LOAC/IHL and other relevant bodies of law to minimize civilian harm. Additionally, military forces avoid actions that undermine efforts by other actors that improve human security.

b. **Deliberate PoC Actions.** Military forces conduct offensive, defensive, and stability actions expressly intended to mitigate harm to civilians, including operations intended to create an environment conducive to PoC.

THE 3-45 POC FRAMEWORK

The *PoC Military Reference Guide* adheres to the pyramid depicted in Figure 1.3.¹⁵ Supporting an overarching PoC philosophy, the guide addresses three fundamentals, identifies 45 tasks, and discusses tactics, techniques, and procedures to accomplish the tasks.

¹⁴ The protection of fundamental individual rights from severe and widespread threats and adverse situations.

¹⁵ Adapted from Giffen, *Addressing the Doctrinal Deficit*, 11 (which further attributes the model to Richard Iron).

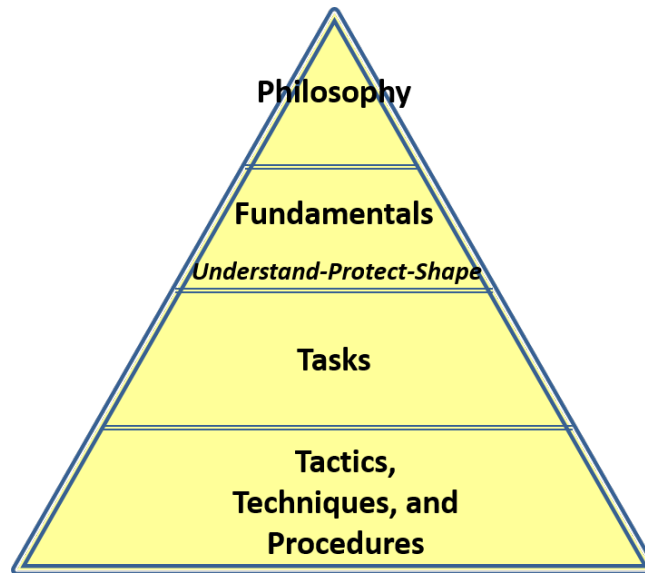

► Figure 1.3: Military ‘Doctrinal’ Pyramid ◀

PHILOSOPHY

PoC is a moral, political, legal, and strategic priority for all military operations. Communities on the ground and around the world expect uniformed personnel to protect the population; failure to do so jeopardizes the credibility and legitimacy of the operation and can undermine other objectives.

3 PoC FUNDAMENTALS (UNDERSTAND—PROTECT—SHAPE)

a. Three overarching fundamentals can assist military forces in the protection of civilians during their operations. Neglecting any of the principles increases the possibility that civilians will suffer unnecessary harm. These principles are not prioritized, but the sequence suggests that military forces should understand the circumstances in which they will operate, determine the goals that should be achieved, plan and conduct operations to achieve the goals, develop synergy with other actors, and shape the surrounding environment to enable success. Figure 1.4 depicts the framework used in the PoC Military Reference Guide, which includes three PoC fundamentals and 45 supporting tasks.

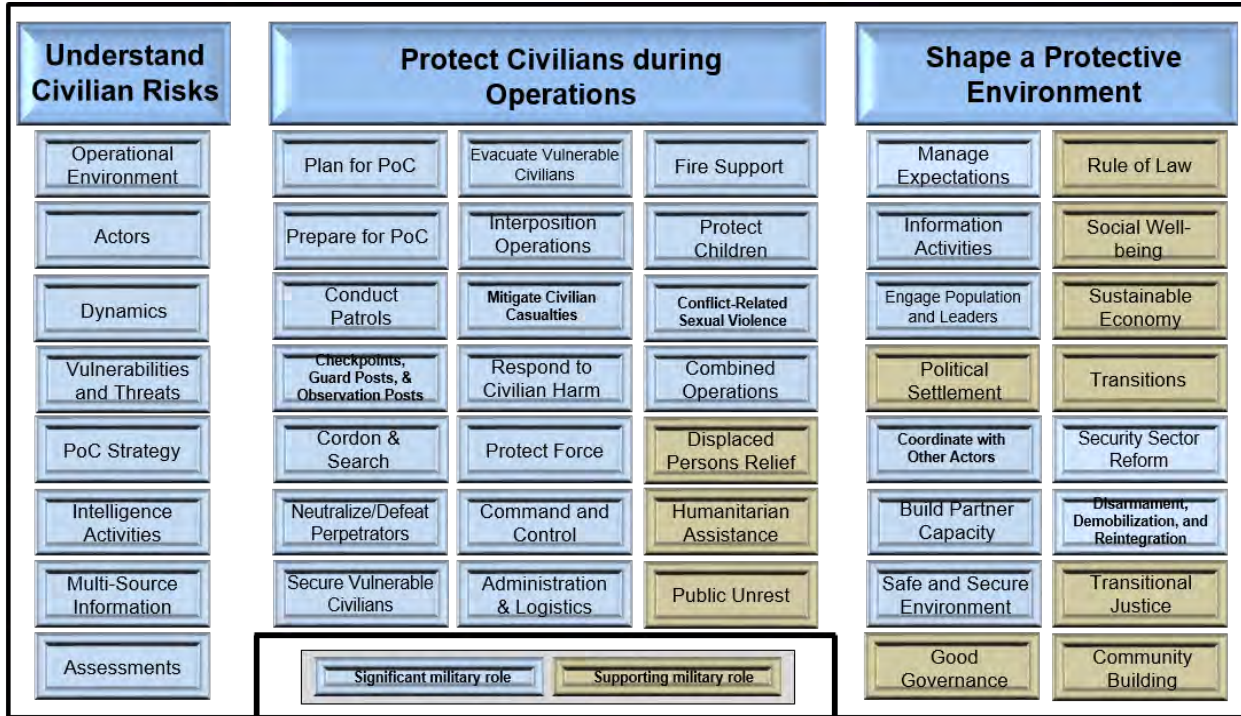

► Figure 1.4: The 3-45 PoC Framework¹⁶ ◀

b. Understand Civilian Risks. Military forces must comprehend the operational environment, the relevant actors, the dynamics, and civilian vulnerabilities and threats. The operational environment includes geographic, military/security, political, economic, social, informational, and infrastructure (GPMESII) considerations that are relevant to PoC, and in many cases the nonmilitary issues are more important than the military matters. Units will have to influence (and, in many cases, should be influenced by) a wide range of other actors that may be loosely categorized as adversaries, vulnerable civilians, bystanders, negative actors, and positive actors. In many situations, the military will operate in support of other actors whose efforts are more important for achieving PoC.

Additionally, it is important to comprehend dynamics such as the strategic guidance and mandates, the strategic logic of perpetrators, the impact of operations, changing vulnerabilities and threats that relate to PoC, emerging opportunities to enhance PoC, and changes in the operational environment or among the actors. The situation will feature a complex and evolving relationship between these variables, requiring good intelligence, efficient information management, and effective current assessments. Although different PoC actors may be reluctant to exchange information and thus compromise their neutrality, confidentiality, or operational security, it may be possible to develop formal and informal information-sharing mechanisms that improve PoC. This principle and the related tasks are discussed in greater detail in Chapter 2.

¹⁶ This framework differs from that in the original PoC Military Reference Guide in two ways. First, it has three fundamental components (*Understand Civilian Risks*, *Protect Civilians During Operations*, and *Shape a Protective Environment*), rather than the five principles used in the first edition. Second, it includes four new tasks (*Understand Civilian Vulnerabilities and Threats*, *Understand the PoC Strategy*, *Secure Vulnerable Civilians*, and *Support the Political Settlement*).

c. Protect Civilians during Operations. Military forces design operations with multiple lines of effort to conduct offensive, defensive, and stability operations to protect civilians. They require functional competence in such traditional military areas as movement and maneuver, command and control, intelligence, fire support, protection, and logistics. Units must have a firm understanding of the use of force and mission-specific rules of engagement with a focus on PoC situations. Operations are often conducted in conjunction with or in support of other actors, such as host-state police forces. While planning, preparing for, and conducting operations, units must routinely and proactively incorporate PoC considerations, as failure to do so can convey the message that violence against civilians is acceptable.

Chapter 3, along with several of the annexes in the *PoC Military Reference Guide*, addresses these issues further, and also discusses PoC within the context of a variety of military tasks such as patrolling, establishing outposts, mobile operating bases, cordon and search operations, the establishment of buffer zones, and noncombatant evacuation operations. This chapter also provides guidance on how to respond to and mitigate incidents of civilian harm, including civilian casualties resulting from military operations.

d. Shape a Protective Environment. In addition to understanding and operating within the environment, military leaders must often help shape it in a manner that enhances PoC. PoC can often best be achieved with a “comprehensive approach” in which military and nonmilitary actors use military and nonmilitary means to achieve military and nonmilitary objectives, with the common understanding that in the long term many of the nonmilitary considerations are the most important. These shaping efforts are achieved through information activities,¹⁷ engagements with key leaders and the population, coordination with other actors, and building partner capacity including within local communities.

The military may be required to support desired outcomes such as a safe and secure environment, good governance, the rule of law, social well-being, and a sustainable economy. These outcomes are often related to peace-building and development and usually must be pursued as parallel, mutually supporting efforts. Failure to achieve these outcomes can result in civilian harm, or inflame grievances that result in conflict and place civilians at increased risk. Military forces are primarily involved with establishing a safe and secure environment which, in addition to improving PoC, is a necessary condition to enable a political settlement, permit a normal life for civilians, and support the other outcomes which should be the primary responsibility of other actors. However, to maintain security units must be flexible and in varying degrees may be required to enable, monitor, or support the other outcomes.

In extreme cases of last resort, military forces may have to assume temporary responsibility for these other areas. At a minimum, military forces should “do no harm” with respect to the accomplishment of the desired outcomes. Related programs often include security sector reform

¹⁷ In the *PoC Military Reference Guide*, “information activities” promulgate messages, inform audiences, or influence perceptions regarding the situation and particularly the objectives and actions of the military force. This term generally incorporates related concepts used elsewhere such as Public Information Activities, Communication Synchronization, Strategic Communication, Information Operations, Public Affairs, Psychological Operations, Inform and Influence Activities, Military Information Support Operations, and other approaches.

(SSR), disarmament, demobilization, and reintegration (DDR), and transitional justice. Chapter 4 discusses these environmental shaping measures as well as considerations during transitions.

POC TASKS

a. The *PoC Military Reference Guide*'s "3-45 PoC Framework" includes 45 tasks that support the three PoC fundamentals discussed above. These tasks generally apply whether or not PoC is a primary objective of the military's mission, although the focus on a particular task will vary depending upon the situation. The tasks are mutually supporting, in that success or setbacks in one task can affect progress in other tasks. While many of the tasks apply to most military operations and may not specifically address PoC, failure to account for or properly perform any of the tasks could jeopardize effective PoC.

b. Chapters 2, 3, and 4 of the *PoC Military Reference Guide* describe the 45 tasks in detail. Each task discussion identifies whether the military would likely perform a major role or would normally support other actors and includes the following elements:

- **Task Description**—brief orientation on the task.
- **Task Relevance to PoC**—why the task affects PoC.
- **How the Task is Accomplished**—explanatory discussion and suggestions.
- **Task Challenges**—potential problems to consider.

c. While the set of tasks in this reference guide is intended to be comprehensive and applicable for most PoC situations, during their mission analysis commanders and staffs should nevertheless validate the framework's adequacy for their particular circumstances. A unit's actual task list should take into account the context (for example, peace operations or armed conflict), doctrine, mandates, rules of engagement, and other considerations. Some of the tasks in the reference guide could be refined to be more relevant to the specific situation confronting the unit, others may not be required, and more tasks may need to be added.

d. Other actors (including domestic and international political, police, humanitarian, and developmental organizations) will have the primary responsibility, authority, and capability to accomplish many of the PoC-related functions. In eleven of the tasks, particularly those associated with shaping a protective environment, the military will generally at most be limited to a supporting and enabling role. The military primarily accomplishes this by maintaining adequate security so that other actors have sufficient space to operate. In extreme cases of last resort, the military may temporarily assume a more prominent role for these eleven tasks. In most cases, military forces at a minimum will have to be aware of the status of all 45 tasks, even if they do not have primary responsibility and authority for some of them. This enables the military to comprehend the bigger picture, helping to ensure that units avoid civilian harm and undermine nonmilitary tasks that ultimately may be the most critical for mission accomplishment.

Chapter 2

Understand Civilian Risks

- **Task 1: Understand the Operational Environment**
- **Task 2: Understand the Actors**
- **Task 3: Understand the Dynamics**
- **Task 4: Understand Civilian Vulnerabilities and Threats**
- **Task 5: Understand the PoC Strategy**
- **Task 6: Conduct Intelligence Activities**
- **Task 7: Manage Multi-Source Information**
- **Task 8: Conduct Assessments**

CHAPTER 2 OVERVIEW

Commanders and staffs must continually understand the interrelated situational variables portrayed in Figure 2.1. Situations will constantly change, and units must remain current in their understanding of these variables so that they can anticipate and adaptively mitigate PoC risks. This requires effective intelligence activities, management and appropriate sharing of multi-source information, and realistic assessments.

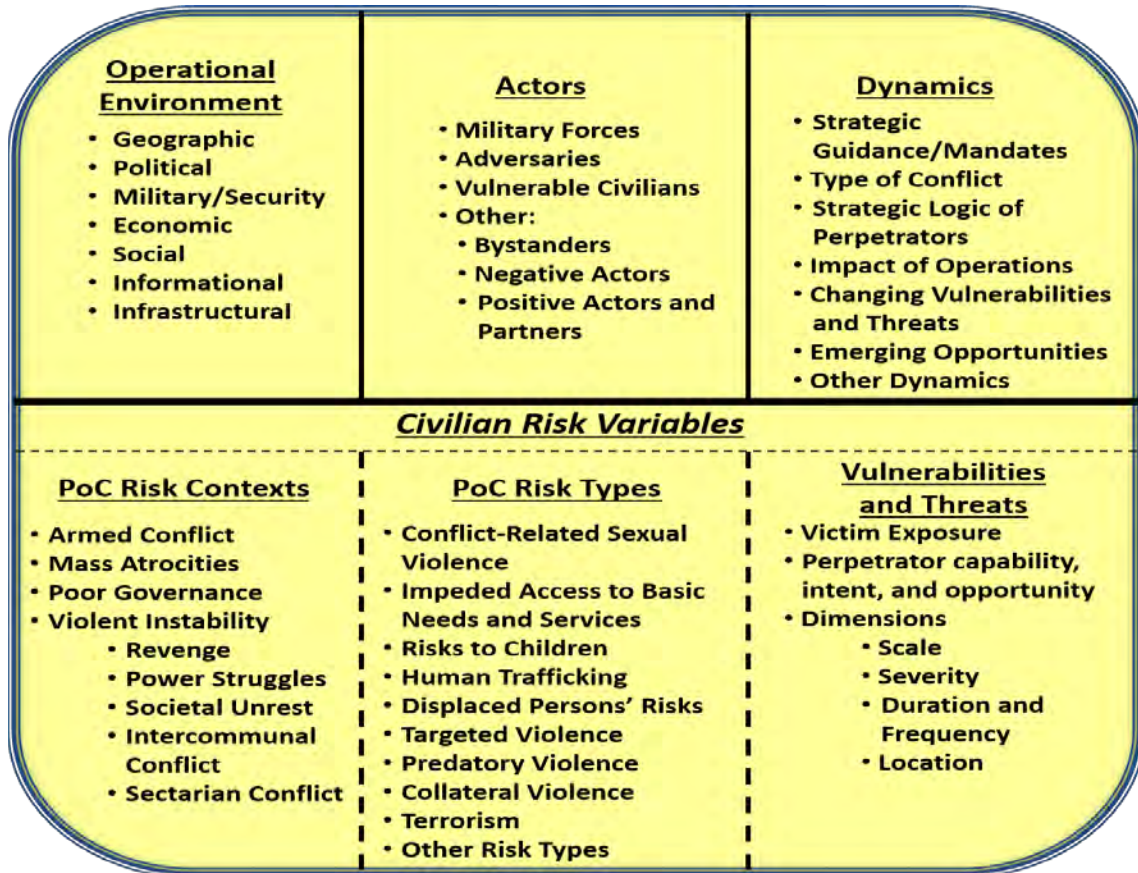

► **Figure 2.1: Situational Variables** ◀

Task 1: Understand the Operational Environment

Task Description

The military force achieves an integrated appreciation of the operational environment which includes geographic, political, military/security, economic, social, informational, and infrastructural (GPMESII) factors. Commanders and staffs should understand key GPMESII considerations as they relate to PoC, including systems, nodes, challenges, opportunities, risks, and other issues.

Task Relevance to PoC

Other situational variables, such as the actors and dynamics, exist within the context of the operational environment. The GPMESII factors can affect civilian vulnerabilities and threats, include issues that drive conflict, and help formulate the solution sets necessary to achieve PoC. The military force should understand the elements, key nodes, and significance of these seven categories as they relate to PoC and the overall mission. This implies that PoC requires the military to understand many nonmilitary issues, as they will frequently be the most significant at any echelon, including at tactical levels.

How the Task is Accomplished

To gain a holistic understanding of the operational environment, leaders and staffs must deliberately and continually assess the GPMESII factors and avoid the natural tendency to focus exclusively on military and security issues.

GEOGRAPHIC FACTORS

a. Geographic factors including the boundaries of the area of operations (AO), terrain, water, climate, and natural disasters have a marked effect on civilian vulnerability and on the ability of military forces to provide protection. For example, civilians in remote and rugged areas can be isolated from responsive support and assistance in the event of natural disasters or violence directed against them. Such areas may also enable operations by spoilers who deliberately target civilians. Particularly if it has adequate aerial assets, the military force may easily be able to identify and target perpetrators in open terrain such as deserts. However, open terrain may also make it easier for perpetrators to attack civilians.

Geographic Factors

- AO Boundaries
- Terrain
- Water
- Climate
- Natural Disasters
- Pollution

b. Water sources may be insufficient and consequently be an incentive for conflict between different groups, particularly if upstream groups over-consume or otherwise deny water to those downstream. Population centers are frequently located near major water sources, and water is critical for crop irrigation and for livestock. Lack of water is itself a threat to civilians. Additionally, water is potentially a cause of conflict between groups whose well-being is threatened by lack of access. Water pollution can be a more serious threat than violence, and areas with an abundance of water may be accompanied by other civilian threats such as pestilence, disease, and flooding.

c. Climatic issues include weather and seasonal changes. Temperature extremes can threaten civilian well-being, particularly those that have been displaced by conflict or other causes. Nomadic population groups often migrate as seasons change, and these patterns could contribute to inter-group conflict, especially as populations grow, resources dwindle, and open lands shrink. Rainy seasons could result in flooding that isolates civilian populations and prevents their access to basic needs and services.

d. Natural disasters including earthquakes, droughts, hurricanes, and tsunamis threaten civilians and the aftermath of these disasters can result in conflict when populations displace or resources are scarce. Civilians may also have increased vulnerability to disease and other post-event effects. Manmade environmental problems, particularly pollution, can jeopardize civilian well-being and limit their access to essential needs such as water.

e. These geographical factors can also affect the operational capability of military forces, their partners, and other helpful actors such as aid organizations. While military forces may be primarily concerned with protecting civilians from violence, they may be called upon to assist with the reduction of civilian suffering from other causes.

POLITICAL FACTORS

a. Military PoC efforts will be conducted within a political context in which the military force is just one actor. Indeed, the military's main role often will be to support PoC efforts, rather than to lead them. Political issues frequently underlie threats to civilians, and political structures and entities can either enhance or undermine PoC. The local, sub-national, national, regional, and international political contexts surrounding a mission will shape PoC objectives, operations, and constraints. Additionally, the failure to protect civilians can cause severe repercussions at all of these levels. Political processes will be instrumental in establishing effective and enduring PoC.

Political Factors

- Issues
- Actors
- Structures
- Solutions

b. Civilians can be at risk from conflict related to political issues such as boundaries, sovereignty, ideology, and the struggle for political power between rival factions. Within these factions, violence can occur between groups such as moderates and extremists with a potential spillover effect that harms civilians. Some countries may be characterized by a powerful centralized political authority, while in others political power largely resides with local actors. Both situations create their own opportunities and challenges regarding PoC. Unofficial actors such as business owners, tribal and religious leaders, and elders may have substantial political clout.

c. Political conflict can be manifested in a variety of forms including insurgency, civil war, terrorism, and political violence. Civilians may be at risk from incidental harm, or deliberately targeted to support political objectives. They can be vulnerable both when the host government is exceptionally powerful and when it is extremely fragile. Any international response will be shaped by political discourse between nations (especially in the UN and regional organizations) and by the domestic politics within these nations.

d. Local norms regarding governance, justice, and rule of law can contribute both to problems and solutions. For example, councils of elders may be used to resolve disputes effectively, while in some cases punishments may be extreme by international standards. Military forces and other international actors may be unaccustomed to such practices, but will need to gain an understanding of local perspectives regarding justice and dispute resolution to foster an appropriate rule of law.

e. Military forces should be aware of the relevant political issues at each level that affect PoC within their areas. They must also be cognizant of the formal and informal authorities and structural processes that impact the operational environment and their own actions. Again, these matters may reside at different political levels; for example, if the military force has a multinational configuration, some of the units may have “*caveats*” that constrain their employment. Military forces must also understand that their operations ultimately serve a political purpose and that their successes and failures will have political consequences. Additionally, it is likely that their military activities will be integrated within a political process, such as the improvement of governance, which will determine the mission’s effectiveness. Military forces provide the security to enable these processes and otherwise support them when it is appropriate to do so.

MILITARY/SECURITY FACTORS

a. This category accounts for the size, organization, locations, activities, capabilities, vulnerabilities, objectives, and intentions of armed groups including military, paramilitary, police, intelligence services, and criminal groups. Military forces need an understanding of these factors as they apply to themselves, other friendly forces, adversaries, and any neutral armed parties that could prove relevant to the operational environment. In particular, they must have adequate self-awareness which generally entails situational understanding two levels above and below a particular echelon (for example, a company commander should understand all perspectives from squad through brigade).

Military/Security Factors

Friendly, Adversary, Neutral:

- Size
- Locations
- Activities
- Capabilities
- Vulnerabilities
- Objectives
- Intentions

b. Armed groups can threaten civilians, enhance PoC, or do both. Vulnerable groups may attempt to defend themselves, and the creation of such militias in some situations could constitute a new threat to civilians. While they could be attacked simply because they are members of an ethnic or other group, in some cases civilians may not be at great risk from such deliberate targeting. Rather, in a lawless environment, the population in its daily activities could be vulnerable to widespread individual acts of violence such as murder, rape, robbery, and kidnapping. Other civilians, such as aid workers, can also be at risk. It will be important for the military to understand civilian attitudes towards and perceptions of different armed actors, including military and security forces.

c. With a comprehensive appreciation of military/security factors in their operational environment, military forces can conduct operations appropriate to the particular circumstances. Forces may maneuver to defend local populations or neutralize specific threats. They may also secure a large area to establish an environment in which nonmilitary efforts such as governance, economic development, and the provision of essential services can progress effectively. Military forces may be required to conduct familiar operations such as patrolling and checkpoints, but they may also be involved in security sector reform (SSR) activities such as advising host-state security

forces; building host-state capacity; disarmament, demobilization, and reintegration (DDR); or other tasks.

ECONOMIC FACTORS

a. Economic issues can have significant impact upon civilian vulnerabilities and potential threats. Armed conflict and natural disasters can disrupt livelihoods and make civilians more vulnerable to various deprivations. While perhaps not directly relevant in terms of direct violence towards civilians, economic issues are nonetheless meaningful when the overall mission objectives include the welfare of the population and securing its support. Additionally, civilians who are concerned about their property and livelihoods may choose to remain in dangerous areas and resist efforts to be relocated.



b. Widespread deprivation and unemployment can result in increased criminal activity when people believe it is their only means to survive. Civilians may be directly targeted by criminals or become caught in the middle between rival criminal groups. Civilians can increasingly suffer as illicit economic activities flourish, such as human trafficking, kidnapping, theft, looting, extortion, corruption, narcotics trafficking, and black marketing. Exploitation of natural resources (such as “conflict diamonds”) can fuel conflict, and there could be economic incentives for some actors to prolong a conflict and avoid a peaceful political settlement. Civilian suffering is further compounded when criminal influences corrupt governmental regulatory, fiscal, and decision-making processes and programs.

c. Other related issues may include monetary resourcing for the military force’s activities, such as local development projects or compensation payments for civilians harmed as a result of military operations. Additionally, economic development may be part of the path forward and military forces may require familiarity with the specific private, international, and nongovernmental economic actors and programs. In particular, military forces may need to assist with establishing a sufficiently secure environment in which these entities can operate.

SOCIAL FACTORS

a. The military force will need to understand social factors such as demographics, culture, identity groups, and other issues. As a new actor in the environment, the military can affect existing relationships and tensions, and military leaders should be cautious about being manipulated by actors with their own agendas.



b. Ethnic, religious, regional, or other social cleavages may also motivate violence against civilians, particularly during civil wars. Any attacks on civilians, regardless of the source, could jeopardize mission objectives. Many will expect that military forces should be able to prevent such incidents, particularly if some of the actors that harm civilians are viewed as partners of the military forces.

c. Social unrest over a variety of issues may generate civil disturbance in which military forces are confronted by large numbers of angry civilians who could quickly become a threat. This could

occur because of long-term fundamental political concerns, new struggles for political power in a post-conflict setting, or sudden situations such as when humanitarian assistance is being distributed to a large and desperate crowd. During these occasions, civilians could be harmed as soldiers attempt to protect themselves or others, and such incidents could cause even greater unrest.

d. A society disrupted by armed conflict will likely have numerous civilian vulnerabilities, particularly if there are large numbers of displaced persons (DPs) who lack food, water, shelter, medical care, and security. Disease, starvation, dehydration, and the climate may be more threatening to civilians than violence. DPs may migrate to militaries to obtain assistance, and in some cases hostile actors may attempt to blend in with the DPs. This will pose a challenge to military forces attempting to balance force protection measures with the desire to provide assistance to DPs.

e. Sexual violence may be manifested in conflict-related sexual violence (CRSV) or sexual and gender-based violence (SGBV) which can exist outside of conflict situations. Sexual discrimination, marginalization, and sexual exploitation and abuse (SEA) by those in authority, including members of military forces or partnered organizations, are related serious problems. Sexual violence is primarily directed at females, but members of both genders can be victims. It can be fostered by a culture of impunity, culturally-accepted biases against women, lack of discipline, and beliefs and behavior that violate accepted human rights standards. CRSV incidents clearly demonstrate that civilians are not adequately protected.

f. Cultural norms will be relevant in how the local population responds to incidents in which civilians are harmed and, accordingly, the appropriate mitigation measures military forces should adopt in different situations. In some cultures, family members may be expected to conduct acts of revenge for the rest of their lives. In others, a one-time token gesture may suffice. Revenge may not be common in some cultures, provided appropriate compensation is made. Monetary compensation could be expected in some places, while it may be viewed as an insult in others. In some situations it may be expected that family members are contacted directly, while in other cultures such contact would not be advisable. Contact with female members of the population may be problematic in some societies, and could require specially trained teams of female soldiers or the use of intermediaries. In many societies widows, orphans, and victims of sexual violence may be especially vulnerable to deprivation.

g. Military forces should obtain training and insight regarding culturally-appropriate behavior from host-state partners and others who can provide useful advice, to include how they should behave if they are the first responders to CRSV. In most cases, key leader engagement will be important to mitigate civilian casualties and prevent incidents from escalating. It may also be advisable to employ teams of female soldiers who are trained to conduct engagements with female members of the population. This can help maintain credibility and avoid misperceptions; however, it does not imply that only female soldiers should address these issues.

INFORMATIONAL FACTORS

a. These matters include the information required to maintain situational understanding and conduct effective operations, as well as the messaging associated with the operations and mission. The GPMESII framework provides a useful way to organize most relevant information, and

additional information regarding the acquisition and processing of such information is discussed later in the chapter.

b. Particularly with respect to the protection of civilians, modern military operations are increasingly transparent. Information technology facilitates the instantaneous global impact of the professional media and individual commentators. In most countries information technology also has profound local impact via social media. Messages can be widely and rapidly distributed, whether or not they are accurate. A limited and local act can have far-reaching strategic consequences.



c. Military leaders must be aware of the importance of information and should consider audiences, messages, and methods of delivery. Potential audiences include the local population, host-state leaders, adversaries, international audiences, and the leaders and populations of the countries contributing troops to the operation. Messages might include that the military force is committed to the protection of civilians, has adopted stringent measures to protect civilians, and sincerely regrets any civilian harm caused by its actions. If appropriate, other messages may emphasize civilian harm caused by adversaries or the role of enablers who provide support to adversaries.

d. Delivery methods may include a range of audio, visual, and audio-visual methods, websites, television broadcasts, radio broadcasts, leaflets, posters, signs social media, and key leader engagement. Military units should maintain a consistent pattern of truthfulness and timeliness in their information activities.

e. Adversaries will use information as a weapon to advance their narratives to justify violence against civilians. They may also attempt to discredit the military force's ability to protect civilians while praising their own. They will not necessarily be truthful in these efforts to exploit PoC as a theme. Additionally, rumors about misconduct by military forces or their partners could undermine the effectiveness of the mission.

f. In addition to providing timely and truthful messages, commanders will immediately be required to manage local and international expectations regarding the provision of security and protection of civilians. The legitimacy of and commitment to the operation may suffer if expectations are not properly managed. Information activities are crucial to ensure that the local population has a realistic understanding of the mission, actions, and capabilities of military forces.

INFRASTRUCTURE FACTORS

a. Key infrastructure, such as bridges and power plants, is often targeted during conflict, which places civilians in close proximity to these targets at risk. Additionally, damaged infrastructure can disrupt the provision of essential services necessary for civilian well-being. If contemplating combat operations, the military benefit of doing so should be balanced against the possibility that the targets are close to civilians, the potential that destroying such targets will unduly harm civilians, or that their destruction will have undesired long-term effects after the operation. Conversely, enemies may attack key infrastructure in areas controlled by the military force, and the protection of civilians in these areas should be considered in security plans.

b. If left unrepaired, damaged infrastructure such as building, bridges, and roads can cause civilian casualties if the structures collapse or if they otherwise create unsafe conditions. Infrastructure that deteriorates from lack of maintenance, as might occur in a fragile or failing state, can also present a threat to civilian well-being and inhibit access to civilians and the return to previous economic activity. Some infrastructure, such as dams, can have catastrophic consequences if they fail. When time and resources permit, the clearance and repair of damaged infrastructure can help prevent future harm to civilians. Military forces may be directly involved in such efforts or may assist other developmental actors who would be better suited.

Infrastructure Factors

- Civilian proximity and use
- Power, Transportation, Medical, Communications
- Essential Services
- Support Military Operations
- Restoration and Improvement

c. Transportation infrastructure such as roads, railways, river ways, bridges, tunnels, ports, and airfields is an important consideration in terms of establishing access to vulnerable populations. It is also significant with respect to the logistics and operations of the military force, as it affects throughput, operational reach, and responsiveness. This infrastructure is also vulnerable to disruption from natural causes as well as adversaries, and a range of other actors will likely compete for access. An extensive air transport network may be required to support military operations, but may provide limited benefit to a host state seeking to restore essential services, economic growth, governance, and the rule of law.

Task Challenges

The major challenge in understanding the operational environment is sorting through the vast amount of frequently-contradictory information and identifying the key elements necessary to achieve adequate comprehension. The operational environment will also continually change, and units will have to be proactive to understand and anticipate evolving circumstances. They will have to synthesize information from a variety of internal and external sources, particularly regarding nonmilitary aspects that likely do not fall within the military’s normal expertise. It may also be difficult to anticipate the indirect impact of some GPMESII factors on PoC.

Task 2: Understand the Actors

Task Description

Units should have a comprehensive understanding of the domestic and international actors in their areas of responsibility. These actors may include individuals, organizations, or broad categories such as ethnic groups, religious sects, socio-economic classes, or regional populations. It is usually helpful to conduct a critical factors analysis to help identify the motivations, capabilities, vulnerabilities, and intentions of the actors, as well as other potential variables.

Task Relevance to PoC

With respect to PoC, actors may be broadly categorized as **military forces, adversaries, vulnerable civilians, and “other” (bystanders, negative actors, and positive actors)**. An understanding of the different actors is essential for the military to comprehend potential civilian

vulnerabilities and threats, as well as the role of different actors in reducing PoC concerns. With such an understanding, units can dissuade actors from becoming adversaries or performing other negative roles, mitigate vulnerabilities, and encourage more actors to perform positive functions. Some actors such as parties to a conflict and state authorities will have formal legal obligations to protect civilians in accordance with LOAC/IHL or international human rights law.

How the Task is Accomplished

Like the previous task, understanding of actors is a continual effort. Unit staffs identify relevant stakeholders, such as those described above, and to the extent possible categorize them with respect to PoC. These categorizations are not necessarily fixed. For example, an actor may change its inclination or may simultaneously fall into more than one category. Prior to a mission, it may be difficult to determine how best to consider an actor or understand how different actors may use violence in different ways. Units should recognize that new actors may emerge, and the tendencies of some actors may change (for example, today's "bystander" could in the future become vulnerable, adversarial, a negative actor, or a positive actor).



CRITICAL FACTORS

A "critical factors analysis" can provide useful insights regarding the actors. Staffs should understand the following critical factors, particularly as they relate to PoC. Potential critical factors are summarized in Figure 2-2, and are defined as follows:¹⁸

a. **Centers of Gravity.** *Primary sources of physical or moral strength, power, and resistance.* A COG is the strength that offers resistance and strikes effective (or heavy) physical or moral blows. At the strategic level, centers of gravity usually are the leadership and/or the population's determination to prevail. At operational and tactical levels, they are often specific military forces.

b. **Critical Capabilities.** *Primary abilities which merit a Center of Gravity to be identified as such in the context of a given scenario, situation, or mission.* Critical capabilities are the significant actions (stated as verbs) that a COG can take in the context of the situation and mission.

c. **Critical Requirements.** *Essential conditions, resources, and means for a center of gravity to achieve its critical capability.* Critical requirements can include a variety of elements such as good weather, intelligence, logistics, communications, mobility, achievements by other actors, legitimacy, and domestic or international support. Critical requirements also may include goals that motivate an actor's behavior.

d. **Critical Vulnerabilities.** *Critical requirements, or components thereof, that are deficient or vulnerable to neutralization or defeat in a way that will contribute to a center of gravity failing*

¹⁸ Definitions are derived from Joe Strange, *Centers of Gravity & Critical Vulnerabilities: Building on the Clausewitzian Foundation So that We Can All Speak the Same Language*, Second Edition (Quantico, VA: Marine Corps University, 1996), 3; Joe Strange and Richard Iron, *Understanding Centers of Gravity and Critical Vulnerabilities* (Stockholm: Department of War Studies, Swedish National Defence College, 2005); and *JP 5-0 Joint Operation Planning* (Washington, DC: Joint Chiefs of Staff, 16 June 2017).

to achieve its critical capability. Plans should exploit the vulnerabilities of adversaries and negative actors while mitigating the vulnerabilities of the military force and other actors. Usually, final success can only be achieved by focusing on a combination of vulnerable critical requirements so that the cumulative effect ultimately produces decisive results.

MILITARY FORCES

a. This category of actors normally includes only those organizations that are responsive to the same chain of command (for example, superior, subordinate, and adjacent units from the same national military) or coalition members. Other organizations, such as civilian, police, supportive host-state security forces, and NGOs are considered as “positive actors” and are discussed later in this task.

b. The center of gravity for military forces and some partners could be higher level political will, legitimacy, command and control, the coalition, or specific forces such as mobile units or air forces.

c. For military forces, critical capabilities may include: maintaining freedom of operation; defeating or neutralizing threats; establishing the necessary conditions for PoC by supporting stability, governance, development, and reconciliation; maintaining the support of the population; and integrating with host state and other partners.

d. Critical requirements for military forces may include legitimacy; unity of effort; leadership; logistics; command and control; mobility (including aviation); and intelligence, surveillance, and reconnaissance capability.

e. For the military force, critical vulnerabilities may include friction with partners regarding policies or burden-sharing; mistakes and transgressions that occur (such as civilian casualties or criminal acts including sexual exploitation and abuse); host-state resentment of foreign troops; loss of host-state consent; fragile domestic or international support for the mission; second-and-third order effects such as an expansion of the conflict; extended and insecure lines of communication; remote and vulnerable small forces (such as patrols and outposts); insufficient force to provide widespread security; and the inability to meet the expectations of other actors. Some units may be poorly-resourced, ill-trained, undisciplined, or nonresponsive to military superiors from other nations. National *caveats* on force employment could limit the potential effectiveness of the force. These critical vulnerabilities could reduce the military’s effectiveness, jeopardize the force’s security, or undermine host-state consent at the tactical, operational, or strategic levels.

	Center of Gravity	Critical Capabilities	Critical Requirements	Critical Vulnerabilities
MILITARY FORCE	Political Will to Respond Effectively <i>(Alternates: legitimacy, coalition, specific forces)</i>	<ul style="list-style-type: none"> Respond Quickly Establish Dominance Defeat Threats to Victims Establish Secure Conditions Support Desired Outcomes Obtain Population Support Integrate w/ Partners and Positive Actors 	<ul style="list-style-type: none"> Legitimacy Broad Participation Unity of Effort Leadership Logistics Command and Control Adequate Force Size & Capabilities 	<ul style="list-style-type: none"> Coalition Disagreements Victims Seek Revenge Mistakes by Forces Resentment of Foreign Interference Loss of Domestic or Int'l Support Vulnerable Lines of Communication Small, Dispersed Units
ADVERSARIES	Leadership <i>(Alternates: Ethnic hatred, ideology, external support, forces, recruitment)</i>	<ul style="list-style-type: none"> Maintain Control Retain Military Support Maintain Population Support Conduct Operations Intimidate Opposition Conceal/Deny/Justify Atrocities Dissuade Intervention Legitimize Actions 	<ul style="list-style-type: none"> Loyal Security Regime Political, Economic, Territorial, Cultural Motivations Control of Info Environment of Fear, Suspicion, Obedience Perks for Elite Plausible Narrative Int'l & Domestic Spt 	<ul style="list-style-type: none"> Corruption Factionalism Supporters' Concerns Population Access to Information Survival Concerns Criminal Conduct Limited Capabilities Targetable Assets
VULNERABLE CIVILIANS	Ability to Survive	<ul style="list-style-type: none"> Maintain Collective Will Resist Perpetrators Appease Perpetrators Maintain Survival Means Obtain Outside Support Flee Conflict Area Achieve Other Desired Goals 	<ul style="list-style-type: none"> Food, Water, Shelter, Security Human Rights Preservation of Culture & Livelihoods Organization Sanctuaries 	<ul style="list-style-type: none"> Weak Protective Capabilities Lack of Political Power Disorganization Collaborators Displacement Effects Limited Outside Access
OTHERS: BYSTANDERS POSITIVE NEGATIVE	Perceived Self-Interest	<ul style="list-style-type: none"> Decide Future Behavior Secure Internal Consensus Obtain Latitude to Act Switch Categories Support Interveners, Perpetrators, or Victims Side with Winners 	<ul style="list-style-type: none"> Political, Economic, Territorial, Cultural Motivations Protection against Perceived Threats Consensus 	<ul style="list-style-type: none"> Susceptibility to External Pressure Perpetrator Threats Preference for Status Quo Internal Divisions Weakness Short-term Considerations Dominate

► Figure 2.2: Example Critical Factors¹⁹ ◀

ADVERSARIES

a. Adversaries impede mission accomplishment and may include perpetrators who threaten civilians as well as actors who directly oppose the military force. They could include insurgents,

¹⁹ Adapted from Sarah Sewall, Dwight Raymond, and Sally Chin, *Mass Atrocity Response Operations (MARO): A Military Planning Handbook* (Cambridge, MA: The President and Fellows of Harvard College, 2010), 108-114.

criminal groups, and terrorists, as well as regular and irregular security forces (including those of the host-state government). Groups that are nominally aligned with the military force or its partners may be viewed as adversaries if they also jeopardize PoC. Some adversaries (such as some local leaders or media) may “attack” the military force with non-physical means and may need to be addressed with non-combat methods such as information activities or key leader engagements.

b. An adversary’s center of gravity could be its leadership, armed groups, financial backing, ideology, recruitment, or other candidates.

c. Adversary critical capabilities may include maintaining control over an area; retaining the support of the military or other armed groups, an elite, or selected international actors; generating or coercing support from a sizable part of the population; conducting operations against victims and any opposition including intervening military forces or peacekeeping missions; concealing acts of violence against civilians from outside observers; attacking “soft networks” such as humanitarian organizations or civilian workers that support the military force or stabilization efforts;²⁰ intimidating other actors; dissuading effective action by the international community and intervening military forces; or legitimizing adversary actions through propaganda and efforts to discredit intervening military forces.

d. Adversary critical requirements may include sufficiently loyal and pervasive armed elements to target civilians and any opposition including intervening military forces; control and manipulation of information; monetary, weapons, political or other support from third-party enablers (including neighboring nations or political or armed groups from other countries); a legitimizing narrative; immunity or anonymity to preclude accountability for their crimes; and general military-type functions such as mobility, command and control, logistics, facilities, recruits, and combat power. Adversaries will often view their motivations (such as political power, the elimination of rivals, profit, or survival) as critical requirements.

e. Critical vulnerabilities for adversaries may include corruption and infighting; limited commitment in the event of adversity or setbacks; loss of support from enablers or the population; insufficient strength and resources; fragile and targetable logistics and command and control; low morale, discipline, or training; and limited capability beyond infantry-type forces.

VULNERABLE CIVILIANS

a. This category includes any civilians who are vulnerable to the threats discussed in Task 4—*Understand Civilian Vulnerabilities and Threats*. While military forces are usually concerned about violence that threatens civilians, they may have to address other vulnerabilities as well. Vulnerable civilians may be defined by political, economic, area, or social affiliation or other characteristics such as gender or age. In some situations, an entire population may be vulnerable without regard for their particular group affiliation.

b. The center of gravity for vulnerable civilians may be survival, to include their continued existence as a distinct identity group.

²⁰ For information on soft networks, see Warren Miska, “Soft Networks: Time to Counter the Enemy’s Logical Strategy” in the *Combatting Terrorism Exchange*, Vol 3, No. 4, November 2013. Also see Scenario 10 in Annex E.

c. Critical capabilities for vulnerable civilian groups may include maintaining the essential means to survive; dissuading, resisting, or appeasing perpetrators; retaining human security and cultural identity; obtaining support from third parties; gaining visibility via the media, humanitarian organizations, or other actors; minimizing the effects of perpetrator actions; or fleeing from the conflict area. Another critical capability could be fighting back against or taking revenge on perpetrators.

d. For vulnerable populations, immediate minimal critical requirements likely will include food, water, security, shelter, and medical care. Other critical requirements could include human rights; livelihoods; gender-related concerns; children's needs; cultural preservation; organization; self-defense capability; sanctuaries; and, eventually, the benefits provided by a stabilized outcome (safe and secure environment, good governance, rule of law, social well-being, and a sustainable economy). In some cases, civilians will willingly put themselves at risk to secure the well-being of their families, pursue political freedoms, preserve their culture and communities, or obtain other critical requirements.

e. Critical vulnerabilities for potential victims may include weak protective capabilities; lack of political power; weak organization; an inability to protect families from retribution; collaborators that assist perpetrators; limited contact with the international community; and a lack of essential means of survival. These vulnerabilities are likely to be exacerbated when civilians are displaced.

OTHER ACTORS

a. This category includes bystanders, negative actors, and positive actors.

(1) **Bystanders** include actors in the host state as well as the international community. They avoid involvement for a variety of reasons, although eventually they could move to one of the other categories.

(2) **Negative actors** include “third party enablers” and provide support to adversaries or otherwise contribute to threats against civilians. Support may include military or financial resources, political backing, information, geographical access, sanctuary, services, and other forms of assistance. Negative actors may be motivated by ideological sympathy with the adversaries, political objectives including opposition to the parties involved in PoC, or profit. Negative actors may be persuaded or coerced into a different category and potentially can become positive actors if they retain leverage over adversaries.

(3) **Positive actors**, such as those listed in Figure 2.3, include host-state and international “partners” and others that perform a constructive role, but operate independently from the military. Partners generally have common objectives with the military force and often coordinate their efforts accordingly. They may or may not be responsive to a common higher authority with the military force. Examples may include host-state governmental organizations (including security forces), international organizations or multinational coalitions, developmental organizations from other state governments, and other public and private civilian organizations. Police forces are among the most important of partners; their very existence is intended primarily to protect civilians

and, ultimately, they must be capable of maintaining domestic security so that a normal society can be established.

	Actors	PoC Objectives	PoC Methods
Domestic Actors	Individuals and Communities	<ul style="list-style-type: none"> •Self Protection •Self Preservation 	<ul style="list-style-type: none"> •Avoidance •Resistance/Confrontation •Submission/Collaboration
	Civil Society	<ul style="list-style-type: none"> •Alleviate Suffering •Maintain Dignity •Promote/Monitor Human Rights •Address Socioeconomic Factors 	<ul style="list-style-type: none"> •Support Rule of Law and Culture of Lawfulness •Accept Diversity •Eliminate SGBV •Protect Children
	Host State Officials and Organizations (Political/Security)	<ul style="list-style-type: none"> •Provide Basic Levels of Security •Provide Rule of Law •Provide Essential Services 	<ul style="list-style-type: none"> •Security Sector Reform •Disarmament, Demobilization, and Reintegration •Transitional Justice
	Non-State Political/Armed Groups	<ul style="list-style-type: none"> •Alternative to Host State •Provide Security, Essential Services, Livelihood 	<ul style="list-style-type: none"> •Support Political Settlement •Respect Human Rights •Disarmament, Demobilization, and Reintegration
International Actors	Humanitarian Actors	<ul style="list-style-type: none"> •Save Lives •Alleviate Suffering •Maintain Human Dignity 	<ul style="list-style-type: none"> •Responsive Action •Remedial Action •Environment-Building Action
	Human Rights Actors	<ul style="list-style-type: none"> •Promote and Monitor Respect for Fundamental Human Rights and Dignities 	<ul style="list-style-type: none"> •Monitoring and Reporting •Advocacy, Engagement, Training
	Development Actors	<ul style="list-style-type: none"> •Address Underlying Socioeconomic Factors Related to Crisis or Emergency 	<ul style="list-style-type: none"> •Pursue Socioeconomic Outcomes that Reduce Drivers of Conflict •Provide for Social Well-Being
	International Offices, Missions, Forces	<ul style="list-style-type: none"> •Mitigate Harm and Adhere to IHL •Proactively Protect •Provide Secure/Stable Environment for Other Actors 	<ul style="list-style-type: none"> •Adhere to IHL; Minimize Collateral Damage; Avoid Abuse by Forces; Make Amends •Political Settlement; Physical Protection; Build Secure Environment

► **Figure 2.3: Positive Actors** ◀

b. Some positive actors, such as many NGOs, will strive to avoid being perceived as partners of the military and should not be identified in such a manner. NGOs that maintain neutrality perform an important role in protecting civilians, and military forces should not attempt to compromise their neutrality.

c. The United Nations Office for the Coordination of Humanitarian Affairs (OCHA) coordinates activities between UN agencies, NGOs, and local actors. To facilitate this, eleven global “clusters” have been created based upon sectors of expertise. Global clusters and lead agencies are depicted in Figure 2.4, and depending upon the situation a similar structure may exist at the country level.

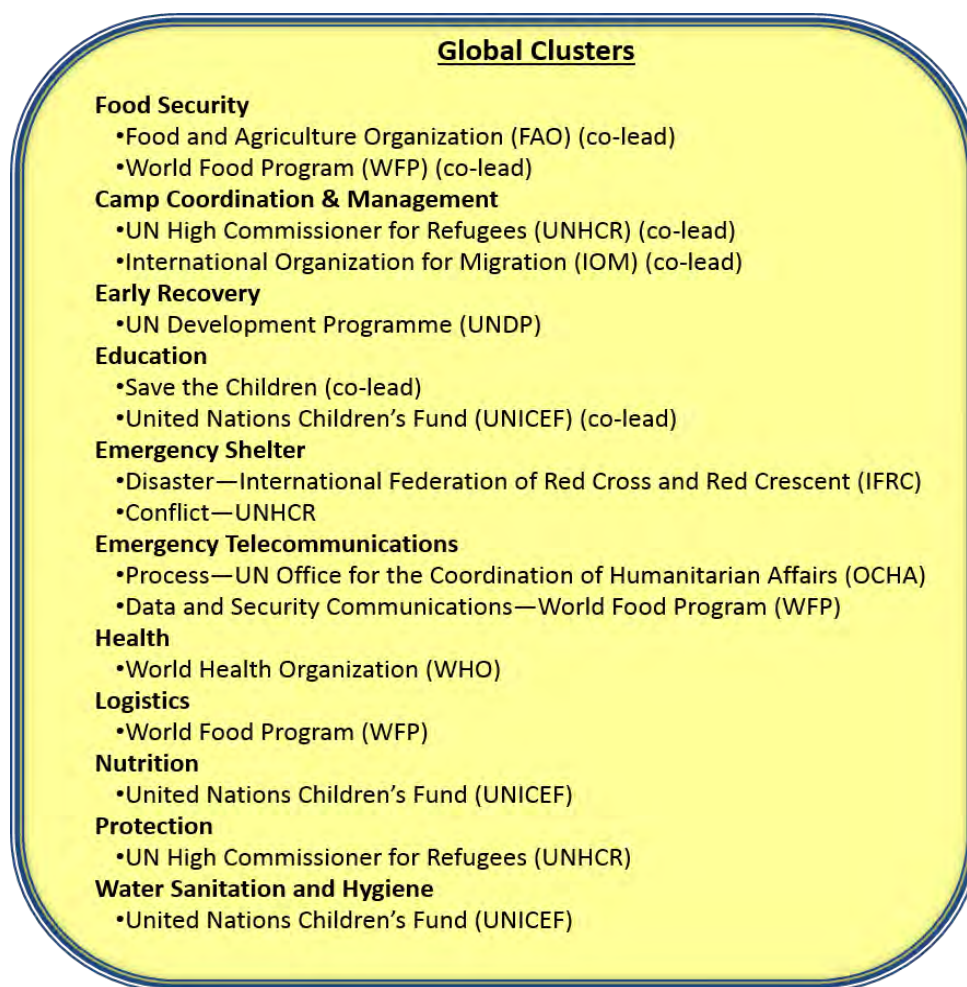

► **Figure 2.4: Global Clusters and Lead Agencies** ◀

(1) The Protection Cluster is headed by the UN Office of the High Commissioner for Refugees (UNHCR).²¹ Clusters are intended to provide the following functions, although an organization’s participation is voluntary.

- Support service delivery
- Inform decision-making
- Develop plans and strategies
- Advocate
- Monitor and report
- Plan and prepare for contingencies
- Build capacity

(2) In addition to the clusters shown above, other areas of responsibility may be identified including child protection, gender-based violence, housing, land and property rights, mine action, age, environment, gender, and HIV/AIDS.

²¹ For more information on the cluster system, see the Inter-Agency Standing Committee (IASC) website at <https://www.humanitarianresponse.info/en/coordination/clusters>.

d. “Other Actors” are often key to conflict resolution and prevention of its escalation, and in establishing an overall environment in which civilians are protected. An important objective is to prevent them from becoming victims, dissuade them from joining or supporting perpetrators, and influence them to act positively regarding PoC. Some can have extremely significant positive or negative roles; these include actors that enable perpetrators with funding, weapons, or political support. Other important actors may include those that support vulnerable civilians or members of the national and international media.

e. “Other Actor” Critical Factors.

(1) The center of gravity for other actors, including some partners, could be their perceived self-interest. This will affect the extent to which other actors will attempt to remain neutral or support other parties.

(2) Critical capabilities for other actors will vary widely, depending upon whether they are inclined towards being bystanders, positive actors, or negative actors. One general critical capability will be following a decision-making process that supports pursuit of the actors’ self-interest or goals. Other actors must also retain the ability to act accordingly, which includes obtaining internal consensus and maintaining the latitude to do so. This may imply a critical capability to avoid antagonizing other parties. For some actors, a critical capability may be to side with the perceived winners in a conflict situation.

(3) For other actors, critical requirements may relate to perceived political, organizational, economic, territorial, or cultural motivations, as well as the desire to maintain security against a variety of potential threats. Some actors may be more concerned about other issues besides the protection of civilians, which could cause them to oppose the military force on other grounds.

(4) A major critical vulnerability is likely to include their susceptibility to external pressure. Internal and external actors alike may be intimidated by adversaries or influenced by the threat of retaliation. This could cause them to support perpetrators, or dissuade them from supporting or cooperating with intervening military forces. Conversely, appropriate influence may motivate them to support PoC efforts.

f. It is important to realize that the actors are not necessarily fixed in a category and may simultaneously fall in more than one. For example, a particular group may be both the victim of violent acts against civilians as well as the perpetrator of violence against civilians from other groups. Despite the fact that the host-state government may have consented to the presence of an international mission, some of its subordinate forces may in fact be adversaries that threaten civilians or otherwise oppose the military force. To the extent possible, military units and their partners should influence the range of disparate actors to behave positively, prevent their becoming victims, and dissuade them from becoming adversaries or negative actors.

Task Challenges

The main difficulty in understanding the actors is identifying and comprehending a diverse array of entities whose characteristics may not be clearly defined. For example, a particular actor

may have a range of motivations that may be contradictory or subject to change. Information on different actors may be incomplete or suspect, particularly if it is largely obtained from unreliable sources or rivals. It will not always be easy to categorize actors as completely “good” or “bad,” and the military force may have to work with adversaries or negative actors to achieve long-term PoC. Units must not overlook groups that are marginalized or have no voice, such as women and children or weak minorities.

Task 3: Understand the Dynamics

Task Description

Military forces must understand how armed conflict and other situational dynamics affect PoC, which necessitates a thorough understanding of the conflict’s root causes and consequences. Dynamics are the major influences that affect the overall situation and potentially include strategic guidance and mandates, the type of conflict, the strategic logic of perpetrators, and the impact of the military force’s own operations. Additionally, as situations will not be static, civilian vulnerabilities and threats will change and new opportunities for PoC will emerge. Finally, key GPMESII considerations regarding the operational environment and the critical factor characteristics of the actors will continually evolve and require reassessment.

Task Relevance to PoC

Conflict dynamics will present ever-changing challenges including new vulnerabilities and threats, but also new opportunities that can be capitalized upon. An understanding of the broad dynamics will help explain specific PoC-related incidents. Conversely, proper interpretation of incidents that occur can help the military force understand emerging dynamics so it can conduct operations that support PoC more effectively.

How the Task is Accomplished

As discussed in the previous two tasks, military forces must develop and maintain a comprehensive and current understanding of the operational environment and relevant actors. Commanders and staffs should also identify the dynamic influences which can affect the situation, anticipate their impact, and understand how the dynamics can be constructively influenced. Units use this understanding to support an effective decision cycle (observation, orientation on critical dynamics, decision, and taking action) to address the following dynamics.

STRATEGIC GUIDANCE AND MANDATES

Military operations will be influenced both by the conditions on the ground and by their strategic guidance and mandates. These two influences can create tensions, and leaders may be challenged in balancing them. In some cases, the requirement to protect civilians can infringe on host-state sovereignty and jeopardize host-state cooperation with the mission. In other situations, failure to protect civilians could result in friction with host-state actors. Strategic guidance and mandates provide the political and legal authorities for military forces, but (since they are usually the consensus achieved after political negotiations) may be vague, incomplete, late, and

continually changing. Relevant formal written guidance may not exist or, if it does, may be obsolete because of more recent verbal direction or a rapidly-changing situation. Additionally, different partners will likely be operating under different sets of guidance. For example, coalition partners will often be responsible to their own national authorities. Senior commanders can be instrumental in shaping strategic direction through their consultations with their political leadership. They should have a good working relationship and shared understanding with relevant political leaders and should consult with them as necessary. PoC will often be included in higher direction, and leaders will often have a choice between using imperfect guidance as an excuse for inaction or a license to act as necessary.

TYPE OF CONFLICT

PoC will likely have to be addressed within the context of a conflict that is already under way or likely to emerge. Examples include inter-state war, a proxy war, civil war, insurgency, secessionist or irredentist conflict, terrorism, a failed state situation, or instability in the aftermath of a natural disaster. The type of conflict will affect the civilian vulnerabilities and threats as well as the military force's actions and mission priorities. The type of conflict may change, particularly as actors adapt and develop new ways to pursue their objectives. It may also be helpful to consider PoC within the context of different scenarios:

- Mass atrocities.
- Armed conflict.
- Government repression.
- Post-conflict instability.
- Communal conflict.
- Predatory violence.
- Mob violence.²²

STRATEGIC LOGIC OF PERPETRATORS

Although they are often portrayed as irrational, perpetrators may deliberately target civilians as a calculated means to achieve strategic objectives which could be legitimate and understandable. Motivations could be due to deep-seated ethnic, political, ideological, or economic grievances; alternatively, such grievances could be manipulated by the perpetrators' leadership. Violence against victims could be pursued for its own sake (for example, to destroy an identity group the perpetrator views as a threat), or it could be a means to an end. An accurate understanding of the perpetrators' strategic logic may suggest a range of methods to improve civilian protection. Some perpetrators may be influenced by a cost-benefit analysis or opportunism, and potentially dissuaded from undesired actions. Others may be undeterred from conducting violence against civilian populations because they believe such action is necessary for their own survival or for other reasons. Different levels of perpetrators (i.e., architects, facilitators, and foot-soldiers) may operate with different thought processes and, consequently, may be influenced in different ways.²³

²² Adapted from Stian Kjeksrud, Alexander W. Beadle, and Petter H.F. Lindvist, *Protecting Civilians from Violence: A Threat-Based Approach to Protection of Civilians in UN Peace Operations* (Oslo: Norwegian Defence Research Establishment (FFI) and the Norwegian Defence International Center (NODEFIC), 2016. See this and other related FFI publications for discussions of PoC planning scenarios including their indicators.

²³ Max Kelly, *Protecting Civilians: Proposed Principles for Military Operations* (Washington, DC: The Stimson Center, Spring 2010), 13-14.

IMPACT OF OPERATIONS

a. Military forces usually must strike a balance between offensive, defensive, and stability actions, and that balance will vary in different parts of the AO and at different times. Commanders should anticipate and understand both the short and long-term effects of the operations on the operational environment, actors, and dynamics. A heavy emphasis on offensive operations may seize the initiative and weaken perpetrators. Conversely, it could provoke retaliation, generate national resistance, result in civilian casualties, or divert forces from long-term stability efforts that may be more important. Operations that are primarily defensive in nature may protect some important locations, but could cede both initiative and territory to adversaries and fail to protect many civilians.

b. Joint operations that are led by foreign forces could fail to develop host-state forces adequately; however, operations by host-state forces may be ineffective or themselves could pose a threat to civilians. Some operations could result in the short-term protection of civilians but result in greater long-term risk, such as subsequent retaliation by perpetrators. Others could be locally successful, but operationally or strategically detrimental.

CHANGING VULNERABILITIES AND THREATS

a. Civilian vulnerabilities and attendant threats will constantly change. The military force should particularly anticipate that CRSV and threats to children are likely to be present in any complex situation, and the nature of these threats may evolve with changing circumstances.

b. Perpetrators may adapt and modify their approaches to targeting civilians, and new adversaries could form that pose challenges for PoC. Perpetrators may want to take revenge, intimidate civilians from cooperating with military forces or other authorities, demonstrate the authorities' inability to provide security and governance, or pursue criminal activities such as kidnapping for ransom, human trafficking, narco-trafficking, extortion, or robbery. It is possible that actors who were previously victims may, in turn, become perpetrators against other victims. New threats could include security forces and others who had previously been "partners" of the military force.

c. Civilians can be threatened as old grievances flare up and new ones arise over issues such as land and water rights, political and religious matters, employment, and a rate of progress that is perceived as too slow or excluding part of the population. Even if violence is held at reasonably low levels, civilians may still be vulnerable to other human security threats such as malnutrition, disease, and a lack of essential services. These can be particularly magnified in the event of natural or other disasters, or policy changes implemented by humanitarian organizations or governments.

EMERGING OPPORTUNITIES

Military forces should be alert for events and trends that can have a positive impact and may be reinforced. Events may be specific occurrences such as meetings, holidays, elections, ceasefires, ceremonies, or seasonal and climactic changes. Progress in one area may be highlighted as a successful model that should be emulated elsewhere. Conflict fatigue may also provide an opportunity; this may be most prominent among groups such as women, the elderly, students, religious leaders, or farmers. It may be possible to encourage and enable such sentiments through effective and concerted IA.

OTHER DYNAMICS

All of the situational GPMESII and actor variables could change in ways that can affect the PoC situation. Military forces must be aware of such changes in the operational environment and continually reassess the GPMESII variables and actors described earlier. Additionally, they should reappraise their situational understanding with partners and other actors to ensure a common appreciation of the issues and measures that should be taken. Some of these possible changes include the following:

- **Operational Environment (GPMESII):**
 - **Geographic:** seasonal changes, natural disasters, droughts.
 - **Political:** international, regional, national, and sub-national debates.
 - **Military/Security:** conflict, capability and capacity changes.
 - **Economic:** indicators such as employment, trade, growth, illicit activity.
 - **Social:** DP movements, group preferences and expectations.
 - **Information:** changes in capability, messages, population access.
 - **Infrastructure:** changes in capacity and needs.
- **Actors:** internal debates, new leaders, new actors, changes in capabilities, requirements, motivations, intentions, vulnerabilities.

Task Challenges

The biggest challenge for commanders and staffs is to understand, prioritize, and ultimately shape dynamic trends that are either not obvious or are in opposition to other dynamics. Additionally, leaders must have an appreciation of their capabilities and limitations in influencing the dynamics. Persistent CRSV and shifting patterns of corruption will likely be intractable problems, and insufficient or obsolete strategic guidance will often be a complication for commanders.

Task 4: Understand Civilian Vulnerabilities and Threats

Task Description

PoC risks are characterized by their context, the types of risk, and the related vulnerabilities and threats. Military forces must have a clear understanding of how the operational environment, the actors, and dynamics shape these variables to plan and conduct operations that protect civilians effectively.

Task Relevance to PoC

Military assessments and plans must account for the interplay between vulnerabilities and threats, and operations should be effectively tailored to mitigate civilian risks. Some vulnerabilities and threats are directly relevant to military operations, while others are less relevant and more appropriate for mitigation by other actors. This task is performed continuously, as vulnerabilities and threats could change rapidly.

How the Task is Accomplished

Commanders and staffs develop an appreciation of the risk context, risk types, civilian vulnerabilities, and threats to civilians. These civilian risk variables are portrayed in Figure 2.5.

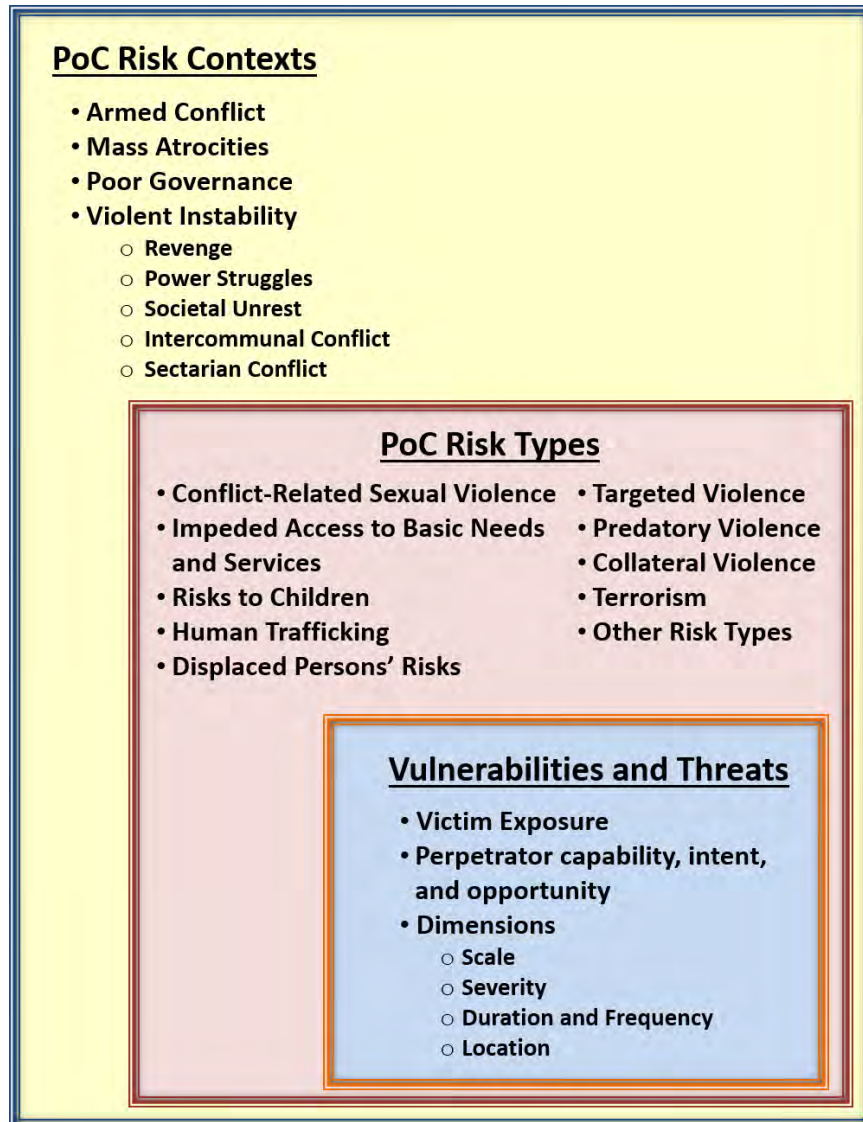

► Figure 2.5: Civilian Risk Variables ◀

POC RISK CONTEXTS

Figure 2.5 depicts four general risk contexts that can result in civilian harm. More than one of these contexts may apply to a specific situation.²⁴

²⁴ See Kjeksrud, Beadle, and Lindvist, *Protecting Civilians from Violence: A Threat-Based Approach to Protection of Civilians in UN Peace Operations* and other FFI publications which discuss eight PoC scenarios: genocide, ethnic cleansing, government repression, communal conflict, predatory violence, insurgency, post-conflict revenge, and mob violence.

a. **Armed Conflict.** This context includes interstate wars, shorter hostilities between nations, civil wars, insurgencies and counter-insurgencies, some peace enforcement actions, and other combat situations. By international law, military forces and other parties to a conflict must conduct their operations according to the following principles:

- Military necessity—actions must fulfill a legitimate military objective.
- Distinction—actions should target combatants and not civilians.
- Proportionality—actions should not cause excessive incidental civilian harm in relation to the anticipated military advantage to be gained.
- Humanity—actions should not use means that cause unnecessary suffering.

(1) Some combatants intentionally target civilians to inflict terror, reduce popular will to continue a struggle, punish an adversary, deter or compel civilian behavior, or to achieve other objectives.

(2) Civilians are often at great risk from incidental harm or collateral damage during military operations, particularly when some belligerents are irregular elements who are virtually indistinguishable from civilians. Civilians are also in jeopardy when belligerents of any type are located among them, to include the intentional and forcible use of civilians as auxiliaries, human shields, or hostages to dissuade attacks by adversaries.

(3) In many situations, civilians are at risk because, through choice or compulsion, they are indirectly supporting a party to the conflict. Examples include camp followers, workers on military bases, labor forces outside of bases, and crews of merchant marine vessels. Other civilians, such as humanitarian assistance workers, can also be at risk due to a perception that they may be directly or indirectly supporting a party to a conflict, or because spoilers view them as vulnerable and convenient targets. While protected under the LOAC/IHL, they could find themselves inadvertently or deliberately targeted because of their activities or locations.

(4) Civilians may also be in jeopardy immediately after combat situations or in post-conflict settings. Damaged infrastructure, fires, flooding, destruction of crops, disease, landmines and other unexploded ordnance, and societal disruption are merely some of the factors that can result in long-term civilian suffering after any hostilities have stopped. Civilian casualty mitigation is discussed further in Task 18—*Mitigate Civilian Casualties* and Task 19—*Respond to Incidents of Civilian Harm*.

b. **Mass Atrocities.** Mass atrocities are widespread and often systematic acts of violence against civilians or other noncombatants including killing, causing serious bodily or mental harm, or deliberately inflicting conditions of life that cause serious bodily or mental harm.²⁵ The Responsibility to Protect (R2P) framework addresses four major mass atrocity crimes including genocide, crimes against humanity, war crimes, and ethnic cleansing.

²⁵ Raymond, Bernath, Braum, and Zurcher. *Mass Atrocity Prevention and Response Options (MAPRO): A Policy Planning Handbook* (Carlisle, PA: Peacekeeping and Stability Operations Institute, 2012), 10. Because it does not have legal standards and burdens of proof associated with it, “mass atrocities” is sometimes preferred as a term to describe situations of extreme violence towards civilians.

(1) Genocide is defined in the 1948 Convention on the Prevention and Punishment of the Crime of Genocide as:

Any of the following acts committed with intent to destroy, in whole or in part, a national, ethnical, racial or religious group, as such: Killing members of the group; Causing serious bodily or mental harm to members of the group; Deliberately inflicting on the group conditions of life calculated to bring about its physical destruction in whole or in part; Imposing measures intended to prevent births within the group; Forcibly transferring children of the group to another group.

(2) Crimes against humanity refer to any of the following acts when committed as part of a widespread or systematic attack directed against any civilian population:²⁶

- Murder.
- Extermination.
- Enslavement.
- Deportation or forcible transfer of population.
- Imprisonment or other severe deprivation of physical liberty in violation of international law.
- Torture.
- Rape, sexual slavery, enforced prostitution, forced pregnancy, enforced sterilization, or any other form of sexual violence of comparable gravity.
- Persecution against any identifiable group or collectivity on political, racial, national, ethnic, cultural, religious, gender, or other grounds.
- Enforced disappearance of persons.
- Apartheid.
- Other inhumane acts of a similar character intentionally causing great suffering or serious injury to body or to mental or physical health.

(3) War crimes are considered as mass atrocities when the following acts are committed as part of a plan or policy or as part of a large-scale commission of such crimes against persons or property protected by the Geneva Conventions:²⁷

- Willful killing.
- Torture or inhuman treatment, including biological experiments.
- Willfully causing great suffering, or serious injury to body or health.
- Extensive destruction and appropriation of property, not justified by military necessity and carried out unlawfully and wantonly.
- Compelling prisoners of war or other protected persons to serve in the forces of a hostile power.
- Willfully depriving prisoners of war or other protected persons of the right of fair trials.
- Unlawful deportation or transfer or unlawful confinement.
- Taking of hostages.

²⁶ Rome Statute of the International Criminal Court, Article 7, paragraph 1.

²⁷ *Ibid.*, Article 8, paragraphs 1 and 2.

(4) Ethnic cleansing is not recognized as an independent crime under international law, but is largely a subset of crimes against humanity or war crimes. Ethnic cleansing situations may overlap significantly with genocidal efforts. Ethnic cleansing is generally understood as the displacement of a population from a territory through force or intimidation.²⁸

(5) Mass atrocities could include eliminationist efforts conducted against groups that are excluded from the formal definition of genocide, such as members of a political group, economic class, education category, dissidents, homosexuals, mentally disabled, or others. Mass atrocities could also occur in non-eliminationist situations, such as reprisals against civilians during a guerrilla or counterinsurgency campaign. They can include extremely brutal acts committed such as systematic rape, human rights violations, and destruction of homes and communities.

(6) Civilians are also vulnerable to perpetrators who are less systematic or who do not have underlying political or strategic objectives. Protecting civilians from mass atrocities or deliberate targeting on any scale may be an important supporting task of a military operation, or it could be the primary objective.

c. Poor Governance. Repressive regimes and extremely fragile states can both create contexts in which civilian well-being is in jeopardy. Poor governance is often accompanied by corruption, nepotism, and cultures of impunity that protect those in power or those with power.

(1) **Repressive Regimes.** Civilians are at risk under repressive regimes that may target elements of the population. Regimes may also intentionally deprive civilians of human rights and essential needs and services. The regime's actions may be directed against selected identity groups, individuals perceived as disloyal, or the general population to compel obedience. A regime will likely escalate its actions against civilians during periods of unrest. Security forces (including the military, police, intelligence services, and paramilitary groups) tend to concentrate more on regime preservation than on protecting the population and frequently will be the actual perpetrators of violence against civilians.

(2) **Fragile States.** Civilians are also at risk when governance is weak or does not exist. Failed or failing states can result in ungoverned spaces, particularly in marginalized areas distant from the capital. Criminal organizations, armed militias, and extremist groups in these areas are likely to act without restraint and compete for power, often resulting in widespread civilian suffering.

d. Violent Instability. Several unstable contexts are characterized by violence that could threaten civilians. These contexts often overlap with one or more of those discussed above. The violence may be widespread or localized, and it may occur sporadically during an extended time period. If the grievances that prompt the instability persist, major outbreaks of violence could erupt at any time, particularly if ignited by a triggering event.

(1) **Post-Conflict Revenge.** Violence may be triggered by a desire to obtain revenge for previous grievances. For example, if a change in government results in a previously

²⁸ United Nations Office on Genocide Prevention and the Responsibility to Protect, *Framework of Analysis for Atrocity Crimes* (New York: United Nations, 2014), 32.

disenfranchised group obtaining power, members of that group may target those viewed as former oppressors and their sympathizers.²⁹

(2) **Power Struggles.** Different groups may violently compete for national, sector, or local power. This may occur when a regime collapses, in the aftermath of armed conflict, or when a government is otherwise extremely fragile. The groups may be motivated by an ideology, loyalty to a warlord or other leader, or the desire for profit. In many cases groups compete for control over resources including land or minerals. They may intentionally target civilians who support other groups, or civilians may be incidentally harmed from the power struggles.

(3) **Societal Unrest.** Parts of the population may mobilize to protest political, economic, or social conditions. The dissent could be a result of persistent grievances, unmet expectations, or a specific event that triggers unrest. Protests could deteriorate into riots and other violence that threatens other civilians and their livelihoods. Additionally, they could prompt regime attempts to suppress the unrest. Such efforts could be particularly brutal and threaten civilians. These efforts, in turn, could result in wider unrest. Military forces engaged in stabilization activities or other operations could also confront outbreaks of unrest.

(4) **Intercommunal Conflict.** Different identity groups, such as tribes or ethnic groups, may conduct acts of violence against each other. The original motives for the conflict could be traced to issues such as land ownership, water rights, conflict between pastoralist and nomadic communities, or livestock rustling. Over time, these motives may be augmented by the desire to retaliate for previous acts of violence by the other community. It is possible that different communities have long been intermingled and peacefully coexisting, but some triggering event occurs to polarize the communities. Intercommunal conflict could be an applicable context at the regional, national, sector, and local levels.

(5) **Sectarian Conflict.** Religious differences can also create violent instability contexts, particularly if intolerant religious extremists do not respect the rights of other faith members, agnostics, or atheists. However, it is possible that any religious differences are incidental to a conflict between groups, and that a conflict's roots are actually based on competition for political power, land, resources, or other motives not tied to religious ideology. Sectarian differences can be a veneer for conflicts that are actually rooted on other issues. Alternatively, previously dormant sectarian differences may become inflamed when other disagreements arise.

POC RISK TYPES

Specific risk types frequently occur within any of the general contexts discussed above:

a. **Conflict-Related Sexual Violence (CRSV).** CRSV consists of violent acts of a sexual nature, including rape, sexual slavery, enforced prostitution, forced pregnancy, enforced sterilization, mutilation, indecent assault, trafficking, inappropriate medical examinations, and strip searches.³⁰ Sexual violence frequently occurs during armed conflict and in fragile states,

²⁹ For more on post-conflict revenge, see Kjeksrud, Beadle, and Lindvist.

³⁰ CRSV is closely related to Sexual and Gender-Based Violence (SGBV), another frequently used term. It is also partially related to Sexual Exploitation and Abuse (SEA), which refers to transgressions by those in positions of

particularly when undisciplined militaries, police forces, or other armed groups believe they can act with impunity. In addition to occurring as non-systematic acts of violence, CRSV can be centrally orchestrated as part of a deliberate campaign of terror against a population group, and as such can be part of a genocidal effort. CRSV is addressed in more detail in Task 25—*Support the Elimination of Conflict-Related Sexual Violence*.

b. Impeded Access to Humanitarian Assistance and Essential Services. Even when they are not displaced from their homes and communities, civilians can lack essentials such as food, water, medical care, and fuel. This can occur because the necessities are not available or because it is too risky for civilians to travel even short distances to obtain them. The problem is compounded during armed conflict. Critical infrastructure, homes, and livelihoods may be destroyed, crops might be burned, and some combatant groups may pillage food and other essentials from civilians in an attempt to “live off the land.”

Additionally, although LOAC/IHL obligates parties to facilitate humanitarian aid, humanitarian workers may be unable to deliver assistance because they are being prevented, they are targeted, or the risk in a conflict situation is too high. In many cases, the civilians’ supplies and humanitarian relief items could be wrongfully appropriated by armed actors. When deprived of humanitarian assistance or essential services, civilians can become victims of malnutrition, dehydration, illness, exposure, and lack of medical care. In some cases civilian deaths from these conditions can exceed those from violence. This topic is discussed in greater detail in Task 28—*Support Humanitarian Assistance*.

c. Risks to Children. Children are dependent upon others to take care of them and are vulnerable to numerous threats and forms of exploitation.³¹ Orphans are especially at risk, and any support programs will require both adequate resources as well as close monitoring. Some governmental and nongovernmental armed groups, such as the Lord’s Resistance Army (LRA), conscript and indoctrinate children as soldiers, which is considered a war crime under the Rome Statute. Planning for military operations may have to account for the likelihood of vulnerable children and child soldiers. When detained or captured, child soldiers will require special handling, treatment, and reintegration. The protection of children is discussed in further detail in Task 24—*Support the Protection of Children*.

d. Human Trafficking. Human trafficking such as slavery, prostitution, and theft of body organs frequently occurs in fragile states and post-conflict situations, particularly when there is widespread poverty and limited rule of law. It results in conditions tantamount to slavery and fosters other crimes such as kidnapping. These activities can be decentralized, but are often controlled by organized criminal groups that may have transnational ties and linkages to those in official, legitimate, and respectable positions. The mandates for peace operations and other military missions may not specifically address the responsibility to prevent human trafficking, but commanders and leaders should ensure that their soldiers³² and police do not support it.

authority, such as government officials or members of a security force. Because a military force may have limited involvement regarding many forms of SGBV (such as domestic spouse abuse), the *PoC Military Reference Guide* addresses CRSV. However, much of its discussion also applies to SGBV and SEA.

³¹ The age that defines a child varies among countries. The UN definition of a child is a person under 18 years old.

³² In this reference guide, “soldiers” refer to any military personnel, regardless of service.

Additionally, it can be a topic of emphasis when interacting with host-state leaders, especially those in security forces. Military forces directly tasked with broader stabilization responsibilities should be aware of the possibility of human trafficking and the supporting criminal networks and address these issues aggressively. This is an area where it is important for military forces to create the space in which the police and other Rule of Law organizations can operate.

e. **Displaced Persons' Risks.** In many armed conflicts, most civilian deaths are due to starvation, disease, exposure, dehydration, and other causes besides violence. Civilians are especially vulnerable when they flee or are forced from their homes and lose their sources of sustenance and communal networks. Generally understood as a person who leaves his or her country due to a well-founded fear of persecution because of race, religion, nationality, membership of a particular social group, or political opinion, the term “refugee” has often been expanded to include any person who has fled from war or other violence in his or her home country.³³ DPs may flee to military bases for protection and may be reluctant to leave thereafter. Large concentrations of DPs often dwarf the availability of necessities to sustain them, and they are often vulnerable to extortion, human trafficking, CRSV, and other acts of violence. DPs and related humanitarian issues are discussed in further detail in Task 27—*Support Relief for Displaced Persons* and Task 28—*Support Humanitarian Assistance*.

f. **Targeted Violence.** Civilians may be at risk when political violence occurs and in extreme cases, such as genocide, ethnic cleansing, and other mass atrocities, perpetrators may deliberately target certain civilian groups to destroy them or force them to leave an area. Depending on the circumstances, some civilians such as members of an ethnic group, journalists, members of a political party, women and girls, military-age males, or international aid workers, may be in greater jeopardy than others.

g. **Predatory Violence.** Some violence against civilians may be localized and opportunistic in nature, and is typically promulgated by criminal groups or rogue security actors. The motivations are often to take money or other resources from civilians, and sexual violence is often a characteristic of this situation. Predatory violence is fostered by poor governance and inadequate rule of law. Transnational criminal networks may be contributors to predatory violence, especially if human trafficking, drug trafficking, and arms trafficking comprise part of their activities.

h. **Collateral Violence.** Even when they are not deliberately targeted, civilians and civilian facilities are at risk during armed conflict and other violent situations because of their proximity to intended targets, misidentification, accidents, or when weapons systems malfunction or are incorrectly employed. Civilian casualties can occur despite stringent mitigation procedures, and the probability increases if belligerents are located among civilians or use civilians as human shields. See Task 18—*Mitigate Civilian Casualties* for more information.

³³ The legal definition of “refugee” and relevant legal obligations are contained in the 1951 Convention Relating to the Status of Refugees, as amended by the 1967 Protocol Relating to the Status of Refugees. Available at <http://www.unhcr.org/3b66c2aa10.html>. In the *PoC Military Reference Guide*, Displaced Persons (DPs) refer generally to legally-defined categories including refugees located in another country, migrants, and internally displaced persons (IDPs) who remain in their own country.

i. **Terrorism.** Extremists may use terrorist attacks to pursue political, religious, or symbolic objectives. These acts are often conducted against soft targets, with civilians frequently the victims.

j. **Other PoC Risk Types.** In addition, the general contexts may create other risks to civilians, including:

- Food and water insecurity.
- Adverse health impacts.
- Adverse environmental impacts.
- Adverse societal impacts.
- Adverse education impacts.
- Adverse economic impacts.
- Property disputes.
- Border tensions.
- Corruption.
- Regional instability.

VULNERABILITIES AND THREATS

PoC risks are a function of *vulnerabilities* and *threats* that create situations in which violence and deprivation harm civilian well-being. The military force should understand vulnerabilities and threats as perceived by the local population, which may have a different perspective from international actors.

a. **Vulnerabilities.** The vulnerability of individuals or populations can be understood in terms of exposure to an imminent or specific threat. For example, ethnic or sectarian violence may target certain groups within a population, rendering those more vulnerable than others. Civilians in the proximity of military targets may be more vulnerable to collateral damage. Some groups may be vulnerable in certain contexts, including women, children, or the elderly, infirm, and disabled. Vulnerabilities may also include a lack of access to services such as food and life-saving assistance. Vulnerabilities can be mitigated with different approaches, often involving other actors besides the military force. Conversely, vulnerabilities can increase if protection actors are not present or are constrained (for example, if they are targeted or obstructed by host-state security forces). Civilians may elect to take actions that they perceive as legitimate, but which could increase their risk from violence. Some potential examples include protesting against grievances, supporting “enemies” of the state, protecting property, assisting family or community members, or resisting displacement efforts.

b. **Threats.** Threats are based upon the capability, intent, and opportunity to harm civilians. Military forces should understand the identity of potential perpetrators (e.g., government forces, government-aligned armed groups and proxies, or nongovernment armed groups). It is important to understand the types of risk created by perpetrators, their motivations and strategies, and their critical factors as discussed in Task 3—*Understand the Actors*.

c. **Dimensions.** Civilian vulnerabilities and threats are assessed based on dimensions that include the following:

- Scale—the number of affected civilians.

- Severity—the level of violence against civilians and civilian depredations.
- Duration and frequency—length of time and rate of occurrence.
- Location—where violence is committed against civilians.

Task Challenges

This task presupposes an effective and continuous understanding of the other situational variables including the operational environment, the actors, and the dynamics. Perpetrators will likely attempt to conceal their efforts to target civilians, and it may be difficult to obtain accurate information, particularly in remote areas. Vulnerabilities and threats can change rapidly due to triggering events such as national disasters, coups, or political assassinations. Unforeseen vulnerabilities and threats could also emerge as second-order effects of previous events and operations.

Task 5: Understand the PoC Strategy

Task Description

Commanders and staffs must comprehend the PoC strategy developed by higher echelons, including the political leadership. They must also develop their own approach for civilian protection and ensure this is understood throughout the command.

Task Relevance to PoC

An effective PoC strategy shapes the role and activities of the military force. Understanding the strategy helps military commanders to ensure their units support PoC objectives and supplement the efforts of other protection actors. Units that operate in the absence of a strategy, or act in contravention of the strategy, may undermine effective civilian protection.

How the Task is Accomplished

a. Strategy entails continuous choices among ends, ways, and means. While “strategic” usually connotes high-level and long-term endeavors, to some extent strategizing can occur at any level. It is important to develop a strategy as soon as possible, but it may be advisable to change a strategy based on new risks and opportunities.

b. It may be appropriate to create a separate and formal PoC strategy, although in some cases PoC considerations are integrated in a single overarching strategy that addresses broader mission objectives. If a formal PoC strategy is to be developed, the UN framework provides a useful format.³⁴ If a PoC strategy document does not exist, commanders and staffs should nevertheless be able to articulate the following components from the framework:

³⁴ See Appendix 11 to Annex G. For more information, see Annex A (Framework for the Drafting of Comprehensive PoC Strategies) in United Nations, *DPKO/DFS Policy on the Protection of Civilians in United Nations Peacekeeping* (New York: UN Department of Peacekeeping Operations and Department of Field Support, 1 April 2015). Also see United Nations, *Protection of Civilians, Implementing Guidelines for Military Components of United Nations*

- Purpose, Scope, and Key Principles of the Strategy.
- PoC Strategic Threat Assessment.
- PoC Response Model and Planned Activities.
- Roles and Responsibilities of Mission Components.
- Engagement and Coordination Mechanisms.
- Preparedness Activities.

Task Challenges

There are at least four challenges regarding the PoC strategy. First, an actual PoC strategy from higher echelons may not exist (or it may be too vague to be of value). For example, a sudden crisis may have resulted in a hasty deployment of military forces without the deliberate formulation of a PoC strategy. Alternatively, strategic leaders may be focused on other mission concerns and devote little or no attention to PoC. A second challenge is a mismatch between ends, ways, and means. A PoC strategy may have ambitious objectives, but the available resources are insufficient to attain them. Third, a strategy may be obsolete with respect to circumstances that have changed. Finally, commanders and other military personnel may neglect the strategy in their daily activities, potentially resulting in tactical incidents that have negative strategic effects.

Task 6: Conduct Intelligence Activities

Task Description

Intelligence activities are vital for situational understanding and include the identification, collection, analysis, and dissemination of information in support of the mission.

Task Relevance to PoC

Military forces rely upon accurate intelligence to provide early warning of risks and opportunities to support planning and operations of any type, and this applies with respect to PoC. Intelligence enables situational understanding of the operational environment, the actors, conflict dynamics, and civilian vulnerabilities and threats to include how these are viewed from the population's perspective. Intelligence activities are essential for early warning systems that identify potential risks to civilians. Intelligence activities and PoC are mutually-reinforcing; civilians will provide information more freely when they can do so safely and if it further enhances their security. In turn, good intelligence should drive operations that improve PoC and make civilians more secure.

Peacekeeping Operations (New York: UN Department of Peacekeeping Operations and Department of Field Support, 13 February 2015).

How the Task is Accomplished

a. Intelligence activities must be effectively managed to identify the desired information, allocate collection assets, analyze information, and use it to enhance operations. Analysis processes raw information into intelligence that is disseminated to support situational understanding and effective operations. The military force obtains much of its information and intelligence from other military organizations as well as from its own assets and units. Some activities and assets are specifically intended to collect information. In other cases intelligence is a side-benefit to activities that are primarily conducted for other purposes.

b. It is important to identify and prioritize the desired information. Intelligence frameworks include commander's critical information requirements (CCIR) and a more complex set of supporting information requirements that comprehensively array the operational environment, the actors, and intelligence collection.

COMMANDER'S CRITICAL INFORMATION REQUIREMENTS

a. Commanders typically develop a manageable set of CCIR, to sort efficiently through the vast amount of available information and prioritize collection and analysis efforts. CCIR includes priority intelligence requirements (PIR) and friendly force information requirements (FFIR).³⁵ Particularly in a PoC context, FFIR may be expanded to include information on civilians, partners, locally-contracted personnel, and other actors. PoC considerations should be incorporated within CCIR. If they are omitted, unit activities will likely be less effective in protecting civilians.

b. CCIR focus information collection and analysis efforts, which will always be limited, and supports:

- Early and comprehensive situational understanding of the operational environment, actors, dynamics, and civilian vulnerabilities and threats.
- Commanders' decision-making.
- Unit reporting.
- Planning and execution.

c. As a general rule, between eight and twelve CCIR elements should provide an appropriate set for a commander and his/her organization to maintain sufficient focus and support mission accomplishment. The CCIR may then be broken down further to identify specific information requirements and collection responsibilities. The unit should obtain information to support CCIR in a variety of ways, including the management of intelligence assets, unit reporting, engagements with the population and other actors, and from other sources such as the media. While the CCIR should be frequently updated to maintain relevance, a representative set of CCIR related to the Protection of Civilians is shown in Figure 2.6.

³⁵ Most FFIR are not obtained through intelligence channels, but are provided through means such as unit status reports. However, FFIR are addressed here for convenience. Some militaries add essential elements of friendly information (EEFI) as a CCIR category. EEFI refers to information about the force that must be kept from adversaries and is related to Operations Security (OPSEC).

Priority Intelligence Requirements (PIR)

- What are the locations, compositions, activities, capabilities, weaknesses, and intentions of perpetrators or other adversaries?
- What support is being provided to perpetrators or other adversaries, and who is providing it?
- Have there been any new significant acts of violence against civilians?
- What are the major threats against civilians?
- Are new adversarial groups forming and, if so, why?

Friendly Force Information Requirements (FFIR)

- Have there been any relevant policy changes by the host state, national governments, the UN, regional organizations, or other key countries?
- Are there any significant changes in the capability of the military force or its partners?
- What significant problems and successes are the military force and its partners experiencing?
- What are the major civilian vulnerabilities?
- What are the future plans of the military force's higher headquarters, subordinates, supporting/supported organizations, and partners?
- What additional resources are required?

► **Figure 2.6: Example Commander's Critical Information Requirements (CCIR)** ◀

INFORMATION REQUIREMENTS

These supplement CCIR with specific information collection items. Sample information requirements that relate to PoC include the following:

a. The Operational Environment and Conflict Dynamics

- What are the significant geographic, political, military/security, economic, social, infrastructural, and informational issues, systems and subsystems, dynamics, or nodes?
- What is their impact on the PoC situation?
- What is their impact on the operation?
- Where have attacks on civilians occurred? Where and when are they likely to occur?
- What conditions have triggered violent acts or brought them to an end?
- How prevalent is CRSV and threats to children?
- How is the operational likely to change during the operation?

b. The Actors

Adversaries

- Who are the adversaries?
- Where are they located?
- How are they organized?
- What are their normal modes of operation?
- What are their capabilities and vulnerabilities?

- What are their objectives and ideology?
- What are their recent and current activities?
- What support mechanisms exist to sustain their operations?
- What covert assets does the adversary have amidst our force, partners, or vulnerable civilian groups?
- What are their possible courses of action? Which are most likely/most dangerous?
- What is the level of government or other complicity with the adversaries?
- Are there any divisions within the adversaries?

Vulnerable Civilians

- Who are the vulnerable civilian groups?
- Where are they concentrated?
- How are vulnerable groups organized, if at all?
- What are their capabilities and vulnerabilities?
- What are their objectives and ideology?
- What are their recent and current activities?
- What support mechanisms exist to sustain them?
- What are their possible courses of action? Which are most likely/most dangerous?
- Are civilians at risk when they interact with or support the military force?
- Have there been any threats or attacks made against contracted civilians, humanitarian workers, or the families of local civilians that support the military force?

Other Actors

- What other internal and external groups are relevant to the situation?
- Which other groups are potential victims or perpetrators?
- How are these other groups organized?
- What are their capabilities and vulnerabilities?
- What are their objectives and ideologies?
- What are their recent and current activities?
- What are their possible courses of action? Which are most likely/most dangerous?
- What is their likely response to our operations?
- What positive contributions can be made by other internal and external groups?

c. Intelligence Collection

- What should be the PIR?
- What are the supporting intelligence collection requirements and how should they be prioritized?
- What collection assets are available (including national assets and those of positive actors and partners)?
- How should collection assets be allocated?
- What are the intelligence collection gaps and why do they exist?
- What are potential external and open sources of information and intelligence?
- What are standing intelligence requirements for military units?

INTELLIGENCE MANAGEMENT

a. Commanders and their staffs must manage collection activities to obtain the desired information. These activities may include ground and aerial patrols, the employment of human sources, unmanned aerial vehicles, monitoring of radio transmissions, and requests to higher headquarters that may be able to allocate limited technical assets. The military force also capitalizes on other activities of its units to support information collection. For example, a logistical unit may deliver supplies to a remote outpost and while doing so may observe PoC-related indicators that can satisfy some information requirements. This implies that intelligence requirements should be systematically included in pre-mission briefings, and that post-mission debriefs can be a useful collection method. In this way, every soldier can become an intelligence sensor.

b. As discussed later in this chapter, information obtained from open sources can also support intelligence efforts and improve the military's understanding of the local culture and perspectives, to include whether civilians perceive that they are being adequately protected. Once a sufficient level of mutual trust is established with the population, Community Alert Networks and other mechanisms can expand the number of available eyes and ears that provide urgent information to the military force.

c. Units should have an intelligence section that serves as a central point to receive information, analyze it, and provide insight to the commander, the staff, subordinate units, and higher, lower, and adjacent intelligence sections. The intelligence section should attempt to use multiple sources of information to corroborate each other and build an accurate, comprehensive understanding that cannot be obtained by reliance on a single source. Some situations may require that intelligence sections should be created for units that do not normally have them, such as company-level headquarters. Intelligence can be disseminated with briefings, websites, maps, and reports. Periodic analytical reports can be useful to support overall understanding of the situation and trends related to PoC. Intelligence should be predictive, with the recognition that it is really addressing possibilities and probabilities which ultimately may not occur.

d. Intelligence centers should be closely integrated with the operations centers that manage all information from a variety of higher, lower, adjacent, and other organizations. The intelligence center must also be integrated with intelligence counterparts at different echelons and in other organizations.

Task Challenges

a. Commanders must ensure that PoC is adequately reflected in their CCIR, as PoC will often compete for attention with other mission considerations. CCIR can quickly become irrelevant if they are not updated to reflect changing situational variables and operational requirements. Adequate supporting resources are required to make CCIR effective, including collection, processing and analysis, and interoperability, and units may have limited capacity to manage the systems required to make CCIR effective. CCIR should not merely be a list that is developed and subsequently ignored; rather, it should be instrumental in focusing information management and operations. CCIR can generate political contentiousness, particularly if it is used to support consultative decision-making.

b. Particularly within multinational forces, units will be challenged in prioritizing intelligence requirements and efficiently collecting and routing information through appropriate channels. Units must pay particular attention to the protection of sources and the methods of acquisition, as well protecting the information itself. They must also consider their own operations security and counter-intelligence efforts against adversaries who are no doubt attempting to collect information on them, possibly by using covert agents or civilians whom the force is attempting to protect. Dispersed units, or those that have brief presence in an area, may find it difficult to make the population feel secure enough to provide useful intelligence. Political and resource constraints may also limit a unit's ability to obtain and exploit good intelligence.

Task 7: Manage Multi-Source Information

Task Description

To support a comprehensive situational understanding in complex environments, military forces will have to supplement its intelligence activities with information obtained from a variety of nonmilitary sources. Additionally, to obtain information from various sources, units will occasionally have to share information with other actors to achieve a common appreciation of the PoC situation.

Task Relevance to PoC

Nonmilitary actors will often have critical information regarding civilian vulnerabilities and threats as well as valuable recommendations to address PoC issues. As mentioned earlier, effective PoC makes the population feel secure and will expand the military's ability to gain additional information. Units will also have to provide relevant information to facilitate a common situational understanding and influence other actors to enhance PoC.

How the Task is Accomplished

a. Information will be obtained via the military's official channels, but other sources can be even more valuable, including civilian agencies, NGOs, the media, and the local population. Many human rights organizations monitor conflict situations, and their reports are often readily available. These can be particularly useful for analyzing trends and to gain familiarity with a situation at the outset of an operation. Military leaders must carefully handle information they receive from NGO representatives in the field, as it could jeopardize their status as neutral actors. Normally, they should not attribute information to the NGOs, and in some cases it may be advisable to delay any use of the information obtained from these sources.

b. Many organizations will be reluctant to cooperate with the military and possibly jeopardize their neutrality. It may be more effective to interact with them through civilian intermediaries, and in any event units should generally treat them as protected sources and refrain from attributing information to them. Local leaders and members of the population can be excellent sources of information, particularly when they believe that their well-being and that of their families will be preserved. Operations that enhance PoC will make the population more forthcoming with information, which in turn will improve the effectiveness of future operations. However, units

should be aware that individuals may have ulterior motives when providing information (such as to undermine a rival), and they should be cautious about trusting a source completely. Any information received should be cross-checked with other sources when possible.

c. Open-source information should be managed within an intelligence section, a joint mission analysis center (JMAC--found in UN peacekeeping missions), intelligence fusion cell, or other central point for collection and analysis. A system may be developed to indicate the credibility of information and reports (for example, “1” may indicate a rumor from a questionable source, while a “5” may reflect information from multiple credible sources).

d. The intelligence center must also have the ability to sanitize information so that it can be released to other actors when necessary. The military force will have to exchange information with other actors to cultivate productive relationships, obtain a common understanding of the situation, achieve common objectives, improve operational effectiveness, avoid duplication of effort, and support information activities.

Task Challenges

Information sharing will depend upon the level of mutual trust, and it will require time and dedicated effort to build this. Information that is shared with others can always be compromised, either through maliciousness or carelessness, thus endangering either operational security or the sources of the information.

Task 8: Conduct Assessments

Task Description

Assessments are conducted to compare the current situation with benchmarks that depict the desired standard. An assessment framework includes monitoring, evaluating, and recommending or directing action. Assessments are conducted to enhance the unit’s understanding and to provide meaningful reports to higher headquarters and other organizations.

Task Relevance to PoC

PoC assessment has two purposes. The first is to understand the situation and identify problems, capabilities, and gaps that need to be addressed to improve human security. The second purpose is to evaluate the performance and effectiveness of the military force (and other relevant actors) in their implementation of a PoC strategy to determine if any changes are required. Changes could include a revision of the PoC strategy, modifications in the military force’s employment, additional training or resources, or transition from one phase of an operation to another.

How the Task is Accomplished

Assessments should be conducted on the general situation, including the operational environment, actors, conflict dynamics, and vulnerabilities and threats described earlier. A general assessment also helps gauge progress towards the desired outcomes described in Chapter 4.

Assessments may also be conducted on particular issues. For example, a unit may require an assessment of the host-state policing capabilities in a small city and gather information such as the number of police, their organization, training, special capabilities (such as investigators, forensics, and children and gender specialists), status of equipment such as vehicles and radios, and adequacy of such administrative and logistical systems as pay, schools, maintenance, and supplies. Information from the military force will inform integrated assessments at higher political levels, and assessments will often be accomplished in conjunction with the host state, other international actors, or nonmilitary components of the mission.

MONITORING

This includes a continuous tracking of the situational variables discussed in this chapter, and is supported by such measures as unit reports, coordination with other actors, key leader engagement, liaison officer reports, intelligence activities, polls and surveys, and a wide variety of other information sources. Monitoring focuses particularly on pre-determined CCIR, intelligence requirements, and indicators.

EVALUATING

Evaluation judges progress towards desired outcomes and determines why the current level of progress exists. It is frequently accomplished by developing measures of effectiveness (MOEs) to answer the question “Are the desired results being achieved?” Measures of performance (MOPs) answer the questions “Are directed actions being accomplished?” or “Are we doing things right?” Indicators are information items that help determine the status of MOPs and MOEs, and should be measurable (quantitatively or qualitatively), collectable, and relevant. In addition to military-related indicators, an assessment framework should include information from other actors, particularly humanitarian organizations. Their inclusion in collection and analysis is feasible only when there is a positive and regular interaction with international organizations and NGOs. Without such stakeholder cooperation, information is likely to be misleading. Examples of metrics in an assessment framework are shown in Figure 2.7.

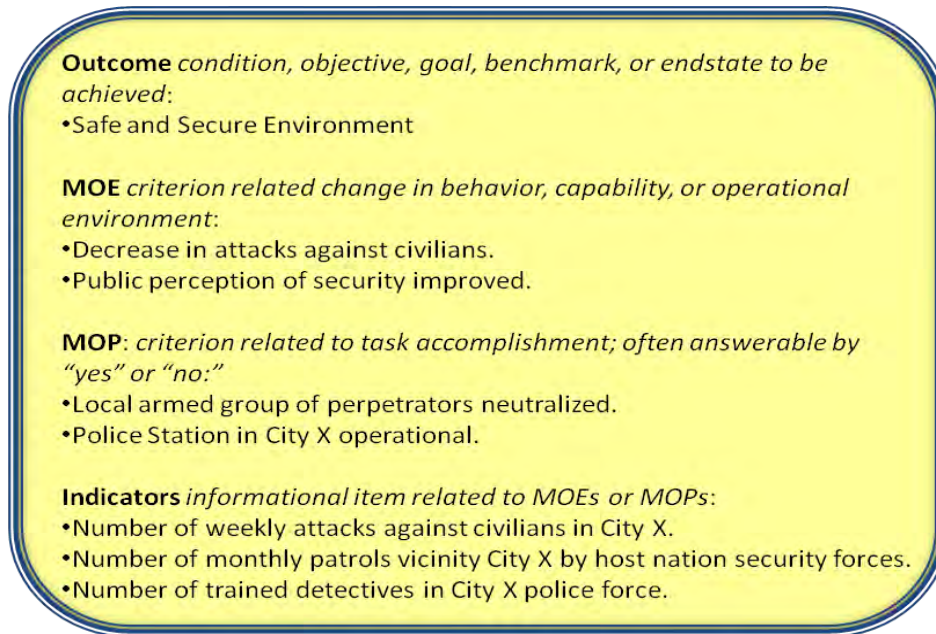

► **Figure 2.7: Example Assessment Framework Metrics** ◀

RECOMMENDING OR DIRECTING ACTION.

MOEs can be useful criteria for decisions to progress to another phase of an operation, conduct transitions, or make significant changes to plans and operations. MOPs can be used as criteria to change procedures or shift the allocation of resources. In some cases, the commander will be able to direct the action required. In other cases, because of a lack of authority, responsibility, or capability, the commander will provide recommendations to superiors or other actors such as host-state officials.

ASSESSMENT FRAMEWORKS

a. Like any organizational system, an assessment framework should be a tool that supports effective operations; it should not be a burden that impairs them. In some cases an elaborate framework is unnecessary because the commander’s understanding is sufficiently comprehensive, or because the situation is so urgent that such a framework is infeasible. Feeding and maintaining assessment frameworks can require extensive resources—especially manpower—that may be diverted from more critical activities. They can also cause units to focus on generating “good” numbers by whatever means possible. For example, if a unit is evaluated on the number of daily patrols it conducts, the result may be a large number of brief excursions rather than a few extended multi-day patrols that might have better operational effect. Information on the ground is often incomplete or questionable, particularly when it is impossible for a unit to monitor every event in a large area of operations. However, as information is reported to progressively higher echelons it may be misinterpreted as being completely accurate and complete. Nevertheless, lack of an effective and systemic assessment framework can result in poor situational understanding, ill-advised operations, and poor information-sharing with other organizations.

b. **Benchmarks.** Benchmarks are tangible standards against which assessments are measured. Benchmarks often relate to desired outcomes or end states, but they can also reflect interim goals

that are waypoints on the path to the end state. As will be discussed in Chapter 4, desired outcomes such as a safe and secure environment, good governance, rule of law, social well-being, and a sustainable economy encompass several supporting conditions that should be pursued.

(1) Benchmarks can provide direction to PoC efforts, particularly with respect to planned transitions. In this regard, they may relate to both the current situation and the preparedness of relevant actors to assume their impending responsibilities and authorities after a transition occurs. Benchmarks may be arrayed along Lines of Effort and within phases, and may be tied to their own supporting MOEs and MOPs. Sample benchmarks are illustrated in Figure 2.8

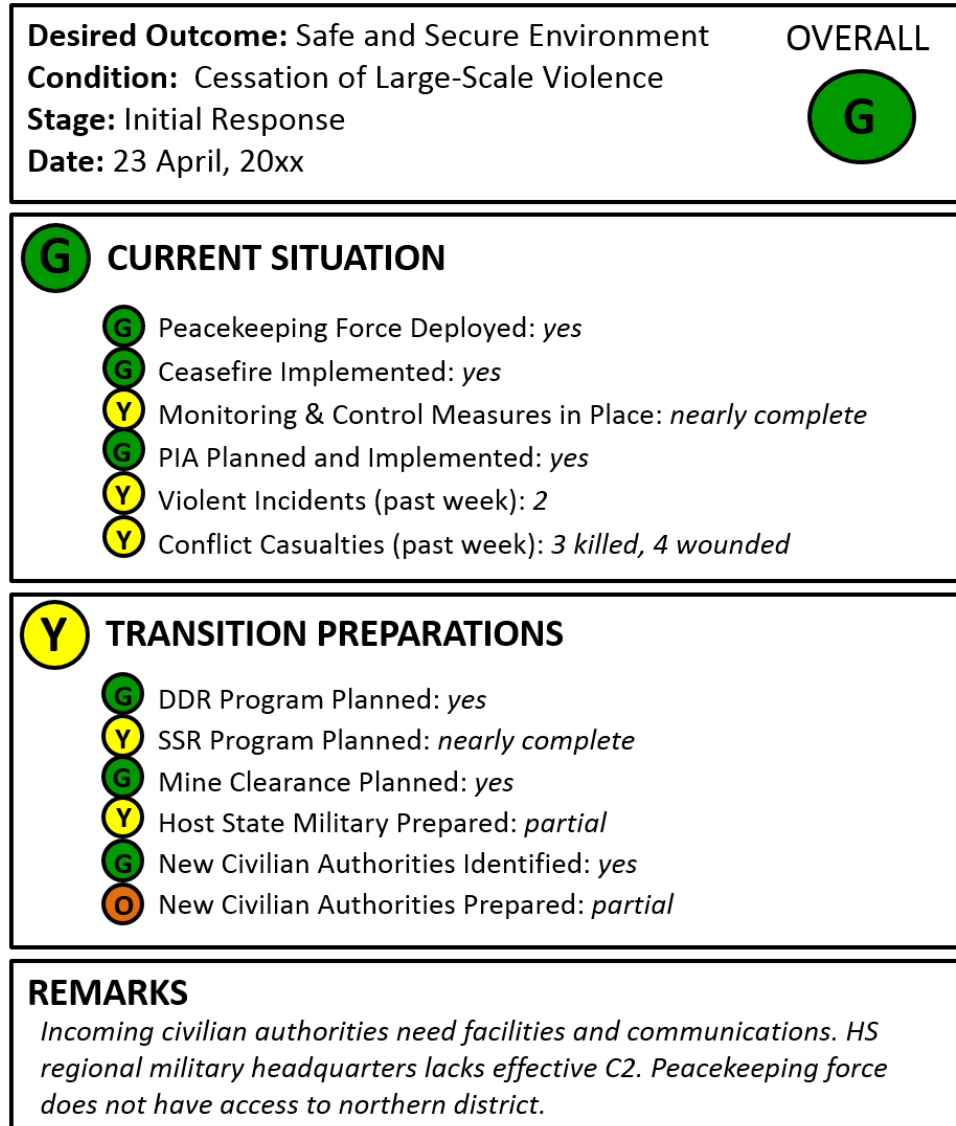

Green (G)—Satisfactory
 Yellow (Y)—Minor Concerns, but transition possible
 Orange (O)—Moderate Concerns, transition risky
 Red (R)—Major Concerns, transition should be delayed
 Black (B)—Extreme Problems, current conditions untenable

► **Figure 2.8: Example PoC Benchmarks** ◀

(2) Benchmarks can likewise be developed for other key endeavors. A consolidated assessment of these efforts should be incorporated into transitions as discussed in Task 41—*Maintain PoC During Transition*. Figure 2.9 depicts such a consolidated assessment.

OVERALL: ORANGE	INITIAL RESPONSE	TRANSFORMATION	SUSTAINABILITY
<u>SAFE/SECURE ENVIRONMENT</u>	G Y Y G Y G Y G Y Y O Y G G G G Y G	Y <input type="checkbox"/> <input type="checkbox"/> <input type="checkbox"/> <input type="checkbox"/> <input type="checkbox"/> <input type="checkbox"/> <input type="checkbox"/> <input type="checkbox"/> <input type="checkbox"/> <input type="checkbox"/> <input type="checkbox"/> G Y Y	<input type="checkbox"/> <input type="checkbox"/> <input type="checkbox"/> <input type="checkbox"/> <input type="checkbox"/> <input type="checkbox"/> <input type="checkbox"/> <input type="checkbox"/> <input type="checkbox"/> <input type="checkbox"/> <input type="checkbox"/> <input type="checkbox"/> <input type="checkbox"/> <input type="checkbox"/> <input type="checkbox"/>
<u>GOOD GOVERNANCE</u>	O O O R O R O R O Y Y Y G O O	<input type="checkbox"/> <input type="checkbox"/> <input type="checkbox"/> <input type="checkbox"/> <input type="checkbox"/> <input type="checkbox"/> <input type="checkbox"/> <input type="checkbox"/> <input type="checkbox"/> <input type="checkbox"/> <input type="checkbox"/> <input type="checkbox"/>	<input type="checkbox"/> <input type="checkbox"/> <input type="checkbox"/> <input type="checkbox"/> <input type="checkbox"/> <input type="checkbox"/> <input type="checkbox"/> <input type="checkbox"/> <input type="checkbox"/> <input type="checkbox"/> <input type="checkbox"/> <input type="checkbox"/>
<u>RULE OF LAW</u>	R O O Y O O R O O R Y O R O R Y O O	<input type="checkbox"/> <input type="checkbox"/> <input type="checkbox"/> <input type="checkbox"/> <input type="checkbox"/> <input type="checkbox"/> <input type="checkbox"/> <input type="checkbox"/> <input type="checkbox"/> <input type="checkbox"/> <input type="checkbox"/> <input type="checkbox"/> <input type="checkbox"/> <input type="checkbox"/> <input type="checkbox"/>	<input type="checkbox"/> <input type="checkbox"/> <input type="checkbox"/> <input type="checkbox"/> <input type="checkbox"/> <input type="checkbox"/> <input type="checkbox"/> <input type="checkbox"/> <input type="checkbox"/> <input type="checkbox"/> <input type="checkbox"/> <input type="checkbox"/>
<u>SOCIAL WELL-BEING</u>	R R R R R R B B B Y O O Y R O	<input type="checkbox"/> <input type="checkbox"/> <input type="checkbox"/> <input type="checkbox"/> <input type="checkbox"/> <input type="checkbox"/> <input type="checkbox"/> <input type="checkbox"/> <input type="checkbox"/> <input type="checkbox"/> <input type="checkbox"/> <input type="checkbox"/>	<input type="checkbox"/> <input type="checkbox"/> <input type="checkbox"/> <input type="checkbox"/> <input type="checkbox"/> <input type="checkbox"/> <input type="checkbox"/> <input type="checkbox"/> <input type="checkbox"/> <input type="checkbox"/> <input type="checkbox"/> <input type="checkbox"/>
<u>SUSTAINABLE ECONOMY</u>	R O O R O O Y O O O Y Y R O R	<input type="checkbox"/> <input type="checkbox"/> <input type="checkbox"/> <input type="checkbox"/> <input type="checkbox"/> <input type="checkbox"/> <input type="checkbox"/> <input type="checkbox"/> <input type="checkbox"/> <input type="checkbox"/> <input type="checkbox"/> <input type="checkbox"/> <input type="checkbox"/> <input type="checkbox"/> <input type="checkbox"/>	<input type="checkbox"/> <input type="checkbox"/> <input type="checkbox"/> <input type="checkbox"/> <input type="checkbox"/> <input type="checkbox"/> <input type="checkbox"/> <input type="checkbox"/> <input type="checkbox"/> <input type="checkbox"/> <input type="checkbox"/> <input type="checkbox"/>

= Current Situation Scoring: Green (G)—Satisfactory
 = Transition Preparations Yellow (Y)—Minor Concerns, but transition possible
 = Overall Status Orange (O)—Moderate Concerns, transition risky
 Red (R)—Major Concerns, transition should be delayed
 Black (B)—Extreme Problems, current conditions untenable

► **Figure 2.9: Example Transition Management** ◀

c. Assessments and benchmarks should be coordinated, where possible, with other cooperative actors to promote a comprehensive and collaborative approach to addressing PoC. Additionally, independent assessments conducted by other actors can provide valuable new information to the military force and help preclude “groupthink” or “tunnel vision.”³⁶

³⁶ A variety of metrics frameworks can be employed, including a modified version of the task list in Annex A. For a useful example with sectors that closely conform to the “desired outcomes” used in this reference guide, see John Agoglia; Michael Dziedzic, and Barbara Sotirin, *Measuring Progress in Conflict Environments (MPICE): A Metrics*

Task Challenges

The main challenge regarding assessments is avoiding the creation of an over-engineered and burdensome information apparatus that interferes with the military's operational effectiveness because of excessive and unreasonable reporting requirements. A second challenge is avoiding the tendency to attribute too much accuracy to assessments that are ultimately based on subjective, incomplete, or inaccurate data. Third, assessment efforts may have unintended effects such as compromising the neutrality of potential information sources, being perceived as "spying" on the host state, or conducting operations that merely try to generate good statistics. Finally, it should be remembered that an assessment framework is merely a tool that can support situational understanding; it is not a substitute for such understanding, which may be largely unquantifiable and undocumented.

Framework (Washington DC: United States Institute of Peace Press, 2010) and USIP/PKSOI, *Guiding Principles for Stabilization and Reconstruction* (Washington, DC: The United States Institute of Peace, 2009). Also see the United Nations in cooperation with the FAFO Institute for Allied International Studies and the Norwegian Peacebuilding Centre (NOREF), *Monitoring Peace Consolidation: United Nations Practitioners' Guide to Benchmarking* (New York: the United Nations, 2010) available at

http://www.un.org/en/peacebuilding/pbso/pdf/monitoring_peace_consolidation.pdf and the International Forum for the Challenges of Peace Operations, *Considerations for Mission Leadership in United Nations Peacekeeping Operations* (Stockholm: Edita Västra Aros AB, 2010).

Chapter 3

Protect Civilians During Operations

- **Task 9: Plan for the Protection of Civilians**
- **Task 10: Prepare for the Protection of Civilians**
- **Task 11: Conduct Patrols**
- **Task 12: Establish Checkpoints, Guard Posts, and Observation Posts**
- **Task 13: Conduct Cordon and Search Operations**
- **Task 14: Neutralize or Defeat Perpetrators**
- **Task 15: Secure Vulnerable Civilians**
- **Task 16: Evacuate Vulnerable Civilians**
- **Task 17: Conduct Interposition Operations**
- **Task 18: Mitigate Civilian Casualties**
- **Task 19: Respond to Reported Incidents of Civilian Harm**
- **Task 20: Provide Command and Control**
- **Task 22: Provide Administration and Logistics**
- **Task 23: Integrate Fire Support**
- **Task 24: Support the Protection of Children**
- **Task 25: Support the Elimination of Conflict-Related Sexual Violence**
- **Task 26: Conduct Combined Operations**
- **Task 27: Support Relief for Displaced Persons**
- **Task 28: Support Humanitarian Assistance**
- **Task 29: Contain Public Unrest**

CHAPTER 3 OVERVIEW

a. PoC requires disciplined, trained, and prepared military forces that plan and operate effectively. This chapter discusses a wide range of tasks to operationalize the use of military force for PoC. Many of the tasks apply to any military operation, whether or not PoC is a significant consideration. Most of these routine military tasks will require some adjustment to incorporate PoC considerations effectively. These tasks are included in the reference guide because PoC could be severely impeded if they are not successfully accomplished.

b. An operational concept for PoC can reflect one or more of the seven following general approaches.³⁷ The operational concept will likely combine the approaches; for example, an operational concept could simultaneously employ the Area Security, Partner Enabling, and Containment approaches. Some approaches may predominate in different geographic areas or during different phases of an operation.

³⁷ Adapted from the *MARO Handbook*. See pages 70-87 for a detailed description of these approaches, the circumstances in which they would be appropriate, as well as the advantages and disadvantages of the approaches.

(1) **Area Security.** Establish control and provide PoC over a large area with sectors assigned to dispersed units.

(2) **Clear-Hold-Build.** Focus initially on securing key areas within the force's capability, then gradually expand security to other areas.

(3) **Separation.** Establish a buffer zone between perpetrators and vulnerable populations.

(4) **Safe Areas.** Provide local security to DP camps and other areas with high densities of vulnerable civilians.

(5) **Partner Enabling.** Support host-state security forces or other actors that directly provide PoC through their operations.

(6) **Containment.** Influence perpetrator behavior through preemptive and retaliatory strikes, raids, and other measures to deter violent acts against civilians.

(7) **Defeat Adversaries.** Attack adversaries to eliminate their ability to threaten civilians.

c. Units should consider their “presence, posture, and profile” which in combination demonstrate that the military force is a willing and capable protector of civilians, and not a threat to the population. *Presence* refers to military units routinely being at the right place at the right time and doing the right things, thus helping to deter incidents and maintain credibility as a decisive influence. Note, however, that the locations and activities of military units should minimize risks to civilians that may arise if military forces are in close proximity. *Posture* is the military force's “body language” that conveys competence, professionalism, readiness, and proper behavior with respect to PoC. *Profile* refers to the public messages that are conveyed by leaders on key issues such as PoC, civil-military relations, and treatment of women and children.³⁸

Task 9: Plan for the Protection of Civilians

Task Description

Military leaders and staffs plan for PoC in two circumstances. The first is when PoC is the primary mission of an operation, and the second is when PoC is a key task or consideration when an operation is conducted to achieve another objective. In either case, commanders and planners should address PoC in their processes and products.

³⁸ General (Ret) Patrick Cammaert, “The Practical Implications of a Gender Perspective in UN Peacekeeping Operations,” speech at the International Conference on Promoting Gender to Build a Lasting Peace: Reflecting on the Latin American Experience, hosted by the Security and Defense Network of Latin America (Buenos Aires, April 2012), available at <http://www.resdal.org/evento-abril/cammaert-discurso-final.pdf>

Task Relevance to PoC

Planning supports PoC by guiding the military force's activities in ways that reduce civilian vulnerabilities and threats while anticipating and lessening the possibility that civilian harm may result during (or in retaliation against) military operations. Efficient planning will help manage PoC crises and other imminent issues. By adding a "PoC lens" to any military planning endeavor (e.g., patrol, target, or convoy planning), leaders can also better ensure their unit actions minimize the potential for civilian harm.

How the Task is Accomplished

Planning is a structured analytical effort that includes the commanders and planners who participate, the process, and the products that result. It may address known situations or potential contingencies, and may be conducted hastily or deliberately depending upon the time available and the level of effort to be allocated. Planning is derived from higher-level guidance and mandates, operational concepts, and doctrine. It incorporates design and employs different conceptual frameworks to achieve the planning objective. In addition to their own internal planning, to the extent possible military forces should also plan for PoC with other relevant actors, particularly host-state military and police forces.

DESIGN

Effective PoC planning requires a comprehensive and iterative design framework consisting of three steps:

a. **Understand the Situation.** This includes a thorough and continuously-updated appreciation of the situational variables as discussed in Chapter 2. The appreciation addresses such considerations as the operational environment (GPMESII³⁹) categories, actors, PoC risks, opportunities, and dynamics.

b. **Frame the Problem Set.** Military forces consider the situational complexities as well as their authorities and responsibilities to ensure they identify all of the key challenges that must be addressed. The problem set should incorporate PoC risks discussed in Chapter 2 and may require periodic reframing as the situation regarding PoC changes.

c. **Develop and Implement an Operational Concept.** Military forces plan and conduct operations to solve the framed problem set, reduce civilian vulnerabilities while exploiting the critical vulnerabilities of perpetrators, and refine the concept as required. The concept should incorporate the appropriate approach(es) described above and incorporate the fundamentals discussed in the *PoC Military Reference Guide*.

PLANNING PROCESSES

Planning is a routine military activity at any echelon, and most staffs use various mechanisms including planning teams, decision-making processes, and orders and other products. Planning should be standardized as much as possible for efficiency, but flexible enough to handle unique

³⁹ GPMESII: Geographic, Political, Military/Security, Economic, Information, Infrastructure. See Task 1—*Understand the Operational Environment* in Chapter 2.

circumstances effectively. PoC considerations should be “mainstreamed” into planning processes; for example, it should be incorporated into the commander’s guidance and used a decision criterion when analyzing courses of action. Annex G includes different planning templates that unit staffs may modify to complement their existing doctrines and procedures. Planning is essentially a rigorous and structured dialogue that develops inter-organizational relationships and teamwork which are often more important than any mechanistic processes or actual plans that are produced.

ROUTINE AND FOCUSED OPERATIONS

It may be appropriate to view a PoC mission as consisting of steady-state “routine” operations that are periodically supplemented by short-term “focused” operations.⁴⁰ Routine operations could include regular patrolling in the operational area, the operation of checkpoints and guard posts, convoys, advising and mentoring of host-state security forces, stability operations, and other activities. Focused operations could include intelligence-driven operations, raids, temporary concentration of resources on an activity, or the expansion of operations into new areas. Focused operations will likely require a dedicated planning effort, while routine operations are normally governed by regular assessments and minor adjustments to the existing plan. PoC should be a prominent feature in both routine and focused operations, and could be the primary consideration in either case.

LINES OF EFFORT

a. Lines of Effort (LOEs) comprise a set of mission-related elements that are necessary and generally sufficient for success. In other words, if all of the LOEs are performed effectively, the mission should be successful. Conversely, if any of the LOEs are unsatisfactory, then the mission would be at risk. An LOE is managed with a focused plan that addresses the related tasks, objectives, and activities contained in the LOE. LOEs collectively help focus command attention, resources, and assessments on critical functions. Consequently, LOEs could change with different phases of an operation. As a general rule, five-to-twelve LOEs provide a reasonable number to manage. LOEs may overlap to a degree, although any redundancy should be minimized. Benchmarks can be developed for LOEs to guide and monitor progress, and they can be assessed with MOPs and MOEs as discussed in Task 8—*Conduct Assessments*.

b. PoC may be an appropriate LOE for most military operations. For peace operations and operations during armed conflict, in which PoC is a primary objective, the LOEs in Figure 3.1 could be used as a comprehensive set that includes many of the concepts discussed in the *PoC Military Reference Guide*. An alternative LOE construct could be based upon the UN Protection of Civilian Resource and Capability Matrix summarized in Annex B. LOEs are frequently mutually supporting; that is, progress in one LOE can support progress in another. Similarly, setbacks in an LOE can also negatively impact other LOEs.

⁴⁰ Sometimes referred to as “framework” and “surge” operations.

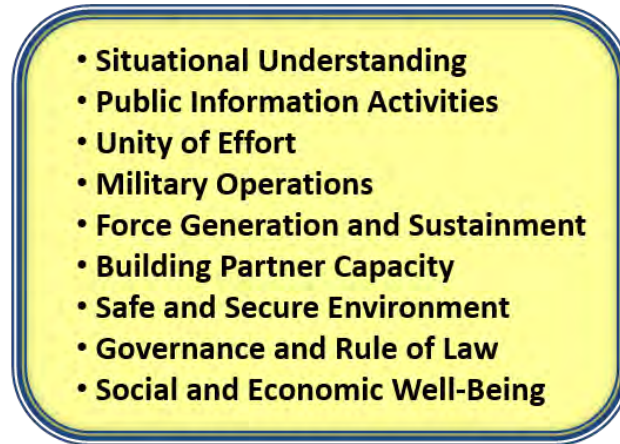

► **Figure 3.1: Example Lines of Effort** ◀

(1) LOE 1: Situational Understanding. This LOE includes the issues discussed in Chapter 2, such as the continuous understanding the operational environment, actors, dynamics, PoC risks, intelligence, and assessments.

(2) LOE 2: Information Activities. This LOE includes messages, audiences, and methods of delivery. Information activities are conducted both to inform and influence, and is closely integrated to developments in other LOEs. It is particularly significant for its potential to manage expectations and influence perpetrators, negative actors, and bystanders. Information activities are addressed further in Task 31—*Conduct Information Activities*.

(3) LOE 3: Unity of Effort. This LOE can be broadly interpreted to include issues related to command and control, leadership, command relations, interoperability, and comprehensive engagement with partners and other actors who are vital for PoC. Comprehensive engagement is discussed further in Chapter 4.

(4) LOE 4: Military Operations. This LOE includes offensive, defensive, and stability actions to protect civilians, defeat perpetrators, or support the achievement of desired outcomes. In many situations, it would be appropriate to divide this broad category into different LOEs (for example: aerospace supremacy, defeat of an adversary force or capability, special operations, or military efforts in particular sectors).

(5) LOE 5: Force Generation and Sustainment. This LOE provides the wherewithal for PoC and addresses designation of forces, deployment, reception, task organization, assembly, basing, administration, and logistics. In many cases, it may be appropriate to account for partnered forces such as host-state security forces. This LOE will be particularly challenging when forces have different points of origin and must be welded into a team after arriving in the area of operations.

(6) LOE 6: Building Partner Capacity. In some cases, elements of this LOE may appropriately fit under other LOEs such as LOE 3 and LOE 5 above. In many situations, however, other partners such as host-state security forces will be so critical that improving their capability

will be a critical focus area for PoC. Partners (or other actors that military forces should enable) could include host-state security forces (military, police, intelligence, and other), other host-state organizations, coalition members, civilian organizations, international organizations, or NGOs. This LOE is discussed further in Task 35—*Build Partner Capacity* and Task 42—*Support Security Sector Reform*.

(7) LOE 7: Safe and Secure Environment. This LOE, which is discussed further in Task 36—*Establish and Maintain a Safe and Secure Environment*, addresses a desired outcome that directly accounts for PoC and is the outcome to which military forces are most relevant. It could include efforts such as DDR and the security of vulnerable groups such as women and children.

(8) LOE 8: Governance and Rule of Law. This LOE includes two closely linked desired outcomes from Chapter 4. While military forces will not have a lasting direct responsibility for this LOE, they can perform an important supporting role and it may be appropriate to identify it as a critical component of the overall effort to protect civilians.

(9) LOE 9: Social and Economic Well-Being. Like LOE 8, this LOE also combines two related desired outcomes that military forces may support. It may be preferable to combine LOE 8 and LOE 9 into one LOE titled “Military Support to Governance and Social Welfare.”

OPERATIONAL FUNCTIONS

Another framework for planning military operations is the use of operational functions. Unlike LOEs, which may be situational in nature and could change as operations progress, the operational functions in Figure 3.2 are enduring considerations for nearly every case. Operational functions are useful for developing plans and assigning staff oversight to ensure that the functions are managed effectively.



► **Figure 3.2: Operational Functions** ◀

a. Command and Control. Command and control includes issues such as the makeup and locations of command posts, command relations, communications and information technology networks, and reporting. In addition to these traditional elements, this operational function also includes leadership, information activities, and comprehensive engagement including inter-organizational coordination and information sharing with other actors including vulnerable civilian groups.

b. Intelligence. This operational function includes efforts to achieve situational understanding and is largely addressed in Chapter 2. It also includes the management of intelligence collection assets and the analysis of information from all sources. It is important to have a clear understanding of vulnerable civilians in addition to obtaining information on adversaries.

c. Movement and Maneuver. Movement and maneuver addresses where and how units are deployed and employed. This function includes traditional offensive and defensive military activities (such as to attack perpetrators or secure vulnerable civilians), but it applies to other mission-related employments of military units. For example, this function would incorporate responding with an infantry unit to a natural disaster, advisory teams that support security sector reform, or the employment of Special Forces.

d. Fire Support. This operational function is most relevant during armed conflict and has three dimensions. First, it includes indirect fires with a strike capability (artillery, mortars, naval gunfire, rockets, and missiles) and airstrikes.⁴¹ Because these systems tend to have widespread and imprecise destructive effects and are employed when positive target identification is a challenge, they often pose a risk of unintended harm to civilians and will be constrained by rules of engagement. Second, this function has a defensive component including air defenses, missile defenses, and counterfire systems such as radars to protect civilians. Third, fire support is often interpreted to include electronic warfare (such as jamming of radios and cyber warfare) against adversary command and control systems. This can be used to disrupt perpetrator communications.

e. Protection. Protection includes both “force protection” measures and PoC considerations. The former set consists of fratricide prevention, operations security, base security, illness prevention, and protective requirements such as chemical defense and counter-terrorism. PoC includes the concepts discussed in this reference guide. An appropriate balance must be struck between force preservation and PoC; units may adopt aggressive deterrent postures or remain bunkered in secure bases, but this could result in incidents of unintended civilian harm or an inability to secure civilian populations. Conversely, units may be intermingled among civilian populations at low security levels, which in turn could make the units more vulnerable to attack. Additionally, while aiming to reassure the surrounding civilian population by their presence, these bases could also draw fire that results in casualties to nearby civilians.

f. Logistics. Logistical matters include the procurement, maintenance, sustainment, administration, and transportation of materiel, facilities, and personnel. Logistical considerations may transcend the requirements of military forces and could include those of vulnerable populations and partners.

Task Challenges

PoC planning challenges may include limited resources and available time, other planning priorities, and ill-defined guidance from higher authorities. Because PoC is a multidimensional issue, its planning would be enhanced with the involvement of other actors. This, however, may

⁴¹ In some militaries, helicopters are viewed as air force assets, and attack helicopter fires interpreted as a form of airstrike. In others, helicopters are considered to be ground force assets that are incorporated under “movement and maneuver.”

not be possible. Good PoC planning depends heavily upon the accomplishment of many other tasks discussed in the *PoC Military Reference Guide*, especially those that support situational understanding. Effective planning must integrate other tasks, including those that shape a protective environment. It will be difficult to anticipate all contingencies and problems, and the military force will have to make rapid adjustments to its plans as appropriate.

Task 10: Prepare for the Protection of Civilians

Task Description

Preparations include measures to train, orient, equip, inform, and inspect soldiers and units so that they can protect civilians while performing other military tasks.

Task Relevance to PoC

Effective preparation results in units that are disciplined and capable of performing all of the relevant tasks described in this reference guide. Units should not focus exclusively on combat-related capabilities and omit preparations that will help protect civilians and interact with the population and other actors. Ill-disciplined, unprepared, and poorly resourced units will be unable to address civilian vulnerabilities and threats, could themselves endanger civilians, and may fail to accomplish their mission.

How the Task is Accomplished

Units prepare for PoC both by conducting long-term preparation for deployments as well as shorter-term preparations for specific operations. Preparations include measures such as individual and unit training, development of standard operating procedures, and the integration of specialized equipment. Perhaps most importantly, leaders must continually emphasize PoC to ensure that units are adequately prepared.

PRE-DEPLOYMENT PREPARATIONS

a. **Training.** Military forces should include PoC as a major training focus when preparing for deployments. In addition to ensuring that soldiers receive training on LOAC and rules of engagement (ROE), it may be appropriate to provide training on PoC and include PoC risk situations in exercise scenarios.

(1) Annexes D and E provide more information regarding PoC training, including suggested programs of instruction.⁴² Annexes B and C discuss PoC as framed by the UN and NATO, respectively. Units should be familiar with the appropriate annex if they will be participating in UN or NATO operations.

(2) During training and exercises, commanders should avoid focusing exclusively on fighting a hostile adversary, as this could reinforce a “shoot first” mentality. Exercises should

⁴² The UN Integrated Training Service has developed operational and tactical Protection of Civilians training materials, and is in the process of replacing these with an integrated set of PoC materials.

include civilians who are not hostile, and units should receive training on the rules of engagement so that soldiers know how to act towards civilians.

(3) Units should develop and train on response procedures when civilians, including humanitarian workers or locally-contracted personnel, become victims. This includes potential situations in which part of the force causes civilian casualties or extreme cases in which genocides, mass atrocities, or crimes against humanity are committed by perpetrators. Units should practice the appropriate response procedures, such as inquiries or investigations, making of amends, and key leader engagements.

(4) Units should “wargame” potential situations, develop unit standard operating procedures (SOPs), and ensure that soldiers understand the importance of PoC as well as their responsibilities. When preparing for operations in situations other than armed conflict, units may require training on rights-based rules regarding the use of force.

(5) Leaders should establish or become familiar with procedures, lessons learned, and any relevant information for their expected operational area. Leaders can provide soldiers a PoC “smart card,” such as that shown in Figure 3.3, to assist soldiers’ awareness of PoC.

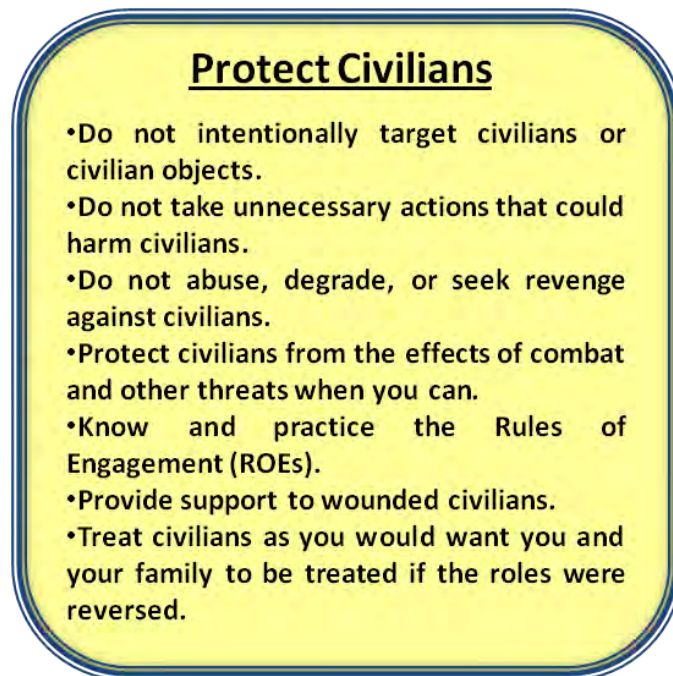

► **Figure 3.3: PoC Smart Card** ◀

b. **Cultural Awareness.** Effective pre-deployment cultural awareness training can help prevent disdainful perceptions of local civilians. Negative attitudes, such as perceiving local civilians as inferior, must be avoided. Leader emphasis on the importance of all human life and cultural respect will help reinforce desired attitudes. Soldiers should not, for example, refer to civilians with disparaging slang terms.

(1) Cultural awareness training should address issues such as the forms of violence anticipated in an operational area (such as blood feuds, ethnic conflict, or suicide attacks), the likelihood that civilians carry weapons, the form and level of host-state rule of law, and whether the host-state government and security forces deliberately target civilians. It should be noted that some local practices may be dependent more on historical, political, or practical considerations than long-standing cultural norms.

(2) The training should also include local customs, particularly those that are relevant for PoC. For example, elders or religious leaders may play a key role in mediating grievances, or women (especially mothers and grandmothers) could exert a strong but publicly unseen influence over the behavior of males. If feasible, training should be conducted in part by personnel with experience in the local culture. Contracted local nationals, such as interpreters and cultural advisors, understand how to interact with the military and can bring a greater understanding of the dangers that civilians face.

c. Command Post Organization. Unit commanders should assign oversight of PoC issues to a staff section or an integrating functional cell. Depending on the circumstances, the operations section might provide general oversight and control during operations. The civil affairs section could manage aspects such as databases or the making of amends. The contracting section could track threats made against any locally contracted civilians.

(1) It may be appropriate to establish a PoC Control Cell or similar structure that meets periodically and includes representation from the operations, intelligence, civil affairs, information, legal, contracting, and fire support sections. The overall proponent should monitor PoC issues in coordination with other relevant staff sections, Civil-Military Cooperation Centers, subordinate units, other commands, partners, and other actors including civilian or host-state organizations.

(2) The PoC Control Cell may include some full-time staff members who collect and analyze data, assist and monitor progress, assess mitigation activities and incorporate lessons learned, monitor PoC response actions, and respond promptly to reports of civilian harm. Such a control cell should be established before deployment, and examples of its responsibilities include:

- Monitor all movements and engagements, possible incidents of civilian harm, reports, inquiries or investigations, information activities, and making of amends.
- Collect, maintain, analyze, and disseminate data related to PoC, including lessons learned.
- Ensure other staff members and subordinate units understand the importance of PoC as well as their responsibilities for reporting, investigating, and taking action.
- Provide frequent and accurate assessments to the commander and other key unit personnel.
- Coordinate effectively with higher, lower, and adjacent units and other partners, including the host state, civilian agencies, international organizations, and NGOs.

d. Specialized Training and Equipment. Pre-deployment preparations may also include acquiring and training on specialized equipment that can help reduce civilian casualties, such as

equipment for signaling and other nonlethal items. Some unit personnel may receive specialized training to help with PoC. For example, unit points of contact should be identified for incidents involving civilian harm, and appropriate staff members can become trained in reports, inquiries, or investigations (including interviews of victims).⁴³ Units may train soldiers on tasks that support PoC such as mentoring and advisory skills, first aid, or medical evacuation. Selected soldiers may be trained as designated marksmen so that small units have an improved capability to engage targets with discrimination and precision.

e. **Standard Operating Procedures (SOPs).** Leaders should make every effort to protect civilians, but they should also anticipate that civilian harm will occur. They should establish systematic procedures in advance to prevent and respond to incidents of civilian harm, including procedures for reporting, tracking, inquiries or investigations, public response, and making amends to families and communities through the recognition of harm, appropriate compensation, apologies, and dignifying gestures. Commanders should ensure that officers in charge of incident handling are reasonably senior within the unit but still have the capacity to spend sufficient time on the task. These officers should also have sufficient operational awareness and ready access to relevant soldiers and information. SOPs should be drawn up to address established timelines for inquiries or investigations and response. Every soldier should be trained on what to do in the case of a known or suspected civilian casualty, including whom to report to and what information to have on hand. Procedures should also be developed for locally contracted civilians that are threatened or attacked.

POST-DEPLOYMENT PREPARATIONS

a. After deploying to an area of operations, military forces will have to make adjustments to their pre-deployment preparations, set conditions in their areas, and prepare for specific missions. Preparation after deployment should include early engagements with local leaders. Units establish relationships with local leaders, explain that military forces have good intentions, discuss procedures for handling unfortunate incidents such as civilian harm, and convey any expectations the forces have toward the local population. Engagements with other civilians, such as NGO representatives, may also be appropriate to develop mutual understanding and reduce the risk of harm as a result of military operations or adversary actions.

b. Leaders must continually emphasize PoC's importance to their subordinates. This can be a particular challenge if their units have suffered casualties, if it is difficult to distinguish adversaries from the general population, or if the population provides support to adversaries.

c. Units should prepare adequately for key operations and events that affect PoC, such as transitions as discussed in Task 41—*Maintain PoC during Transition*.

d. **Relationships with the Host State.** Leaders should attempt to establish early good personal relationships with respected host-state leaders at all levels, as this can be critical to protect civilians effectively or to mitigate the effects of any civilian harm that occurs. Host-state representatives may include political, religious, or tribal leaders, and it may be appropriate in some situations for

⁴³ Some policies, such as those in UN peacekeeping missions, may strictly limit a military unit's authority to conduct investigations.

military forces to expand contacts to include members of the business community, academia, women's groups, minority groups, or others. Host-state leaders frequently will interact with military forces on a variety of issues, and PoC should be included in the dialogue when appropriate.

(1) In some cases, PoC concerns may be preemptively addressed before an actual incident. In their engagements with community leaders, military personnel should emphasize the importance they assign to protecting civilians, explain the rationale behind some military procedures, discuss ways to prevent incidents and enable local leaders to report imminent PoC threats to the military force, and mutually develop procedures should incidents of civilian harm occur. As discussed in Task 31—*Conduct Information Activities* and Task 32—*Conduct Engagements with Key Leaders and the Population*, it is also important to engage with the wider host-state population.

(2) PoC should be addressed with any partnered host-state security forces, which should also develop their own procedures to protect civilians. This should be a recurring area of emphasis during any SSR efforts. In many situations, host-state security forces will ultimately assume the lead for civil security, and their approaches to PoC could be decisive; consequently, PoC should be an integral part of the training and mentoring provided to host-state forces.

e. **Mission Preparation.** PoC should be a routine consideration as units prepare for specific missions. As part of their planning and rehearsals, units should include contingencies related to PoC such as: unit encounters with civilians, situations in which civilians are being threatened or attacked, contact with adversaries in populated areas, and procedures if casualties occur, including incident reporting.

(1) Leader inspections should verify that units are equipped with items such as signs to inform the population and claims cards that can be provided to civilians in the event of an incident. Leaders should continue to emphasize that civilians should always be treated with respect and kindness.

(2) Interpreters are usually more effective with advance preparation, and they should be instructed as to how to address possible situations such as encounters with civilians, directing civilians from danger, responding to civilian casualties, and engagements with host-state leaders. In some situations, interpreters may be able to provide helpful cultural advice as to how soldiers should address these situations.

f. **Logistical Preparations.** PoC preparations may include the procurement, distribution, and maintenance of nonlethal equipment such as signaling items; items to disable individuals and equipment; and equipment such as shields, batons, and faceguards that may be issued to soldiers performing crowd control tasks.

(1) Military forces may require large quantities of barrier materials for bases and checkpoints to provide security and standoff. Engineering support may be required to assist with these efforts, and infrastructure repairs may help reduce the risks to civilians. For example, road craters could be repaired which would remove a hazard to civilian traffic and would also reduce

the ability of adversaries to seed these craters with explosive devices. In some cases, the military may provide transportation, supplies, or other support for delivering humanitarian assistance.

(2) See Task 22—*Provide Administration and Logistics* for additional considerations.

g. Even after they are well-established in an area of operations, military forces should be adaptive and conduct other required preparations (including any necessary additional training) based upon changing situations, experiences (including those of other units), new equipment, or newly-assigned personnel or subordinate organizations..

Task Challenges

Units may lack the time and resources to be adequately prepared, and once deployed may be stretched too thinly. It will be hard for any unit to be completely prepared for all of the problems it will encounter in a complex environment, and units will have to prioritize and economize judiciously. Effective preparation requires good leaders at all levels who are committed to PoC and exercise necessary initiative when they encounter unforeseen circumstances. Pre-deployment preparations will be challenging for teams that do not come together until after they are deployed. Once deployed and operationally committed, the military force will often find it difficult to make procedural and training adjustments that may be appropriate.

Task 11: Conduct Patrols

Task Description

Small units, normally of platoon-size or smaller, conduct reconnaissance, combat, or presence patrols. Reconnaissance patrols are conducted primarily to provide close-in security or obtain information about a specific location or a larger area, while combat patrols include ambushes and raids and are intended to defeat an adversary. Other patrols circulate through and establish presence in the operational area to reassure the population and dissuade potential adversaries. Regardless of their primary purpose, all patrols can provide an additional PoC benefit of establishing the military's presence in an area and improving situational awareness. Many other activities, such as logistical convoys or routine helicopter flights, can perform a secondary patrolling function. Patrolling tactics are normally accomplished in accordance with national military doctrines.

Task Relevance to PoC

a. Patrolling is often the most common and most important task military forces perform to support PoC. Patrolling is necessary to understand the situation, reassure the population, deter or defeat perpetrators, and provide area security. Patrols may be conducted specifically to enhance PoC, or they may be conducted primarily for other objectives, with PoC as a secondary effect. For example, PoC-specific patrols may be conducted so that villagers may safely gather firewood or obtain water. On the other hand, patrols for any purpose can support the reduction of Conflict-Related Sexual Violence and support child protection, as long as patrol members understand that these are expectations and they conduct the patrols accordingly.

b. Patrols should proactively ask questions to assess threats to the population and may be approached by civilians with protection concerns, such as abducted women or children who have escaped their captors and who are seeking assistance. Forces that remain static on their bases usually have limited impact; however, poorly-conducted patrols may be worse than none at all.

How the Task is Accomplished

a. Depending upon the situation, patrols could range in size from two soldiers to a platoon and could last from a few minutes to several days. Regardless of their primary purpose, the majority of military movements should be treated as patrols that can provide reconnaissance, engage in combat with adversaries, or establish a presence to support a safe and secure environment. A military force in an operational area will often be stretched thinly, and it should capitalize upon every possible movement to help establish and maintain security. Consequently, while a particular unit's primary purpose may be to serve as a security escort, deliver supplies, attend a meeting, or accomplish a wide variety of other tasks, it also has the secondary purpose of conducting a patrol and should plan and conduct the movement accordingly.

b. Patrols may be dismounted or mounted (or a mixture of the two), and aircraft can also perform a patrolling function during their flights. Dismounted patrols can permit greater interface with the population and allow access to locations that are inaccessible to vehicles. Mounted patrols provide greater area coverage and allow the patrol to carry more equipment and supplies. Even when a mounted patrol is conducted, it is important to dismount and to interact with the local population. Patrols must be able to communicate directly with the population, to understand the extent of any violence or threats. They should be proactive, rather than reactive, and seek information from the population which may be reluctant to provide it if they feel it is too risky. The population should view patrols as a source of security, and not as a threat.

c. Units can achieve efficiency by developing procedures that are familiar to soldiers and leaders. Such procedures can assist with required functions such as planning, intelligence, logistics (e.g., interpreter support and casualty evacuation), quick response forces, fratricide avoidance, and command and control.

PATROL PREPARATION

a. PoC considerations should be incorporated into planning and preparation for patrols. All soldiers in the patrol, at a minimum, must understand the following information:

(1) Situation.

- Adversary (identification, recent activity, threats, and capabilities).
- Friendly (units in the area, including host-state security forces).
- Civilian (composition, attitudes towards the military force, vulnerabilities).
- Light and Weather (sunrise and sunset, moonlight, temperatures, winds, precipitation).
- Information Requirements.

(2) Mission. (task and purpose)

(3) Execution.

- Intent.
- Endstate.
- Concept of the Operation.
- Tasks to Subordinate Units.
- Fires (including close air support).
- Coordinating Instructions.
 - Timeline (marshalling, rehearsals, briefing, inspections, initiation of movement, halts, destination arrival time).
 - Order of movement, formation, manifest, and load plans.
 - Speed and catch-up speed.
 - Interval (open areas and built-up areas).
 - Weapons orientation and status.
 - Route and checkpoints.
 - Intelligence collection priorities.
 - Location of interpreters.
 - Actions on contact.
 - Actions on breakdowns.
 - Actions at the halt (short and long halts).

(4) Logistics.

- Medical (location of medical support, potential helicopter landing zones)
- Maintenance (location of maintenance personnel, tow-bars; stranded vehicle procedures)
- Other Logistical Information

(5) Command and Signal.

- Location of patrol commander and sequence of command
- Vehicle/unit call signs
- Frequency
- Medical frequency
- Alternate frequencies and phone numbers (if appropriate)

b. Other information may be added, such as procedures for dealing with civilians, including hostile crowds, displaced civilians, or victims of violence. Patrol members should be continually aware of their responsibilities to protect civilians while treating them with dignity and respect and to maintain a professional and disciplined bearing. Interpreters will be key, although their traits (such as ethnicity, age, gender, and linguistic ability) can be important variables. Interpreters may perform better if they are prepared beforehand on likely discussion points. Patrols should be prepared for the possibility that the mission's duration could be extended, and ensure they have sufficient supplies such as water, fuel, rations, batteries, and night vision devices.

c. Higher headquarters should manage patrol plans, carefully considering potential threats, the locations of vulnerable civilians, the size and capability of the force, other mission requirements, the danger of establishing a predictable pattern of behavior, and the need to have a sustainable operational tempo. The requirement to establish a credible presence to protect civilians must be

balanced against the possibility that small isolated units could be vulnerable to attack. This could dictate that some patrols should be more robust than normal, with provisions for quick and effective reinforcement.

d. Combined or integrated patrols, such as with host-state security forces or civilian organizations, are frequently beneficial both to have patrol members that are familiar with the people and the environment and to improve the capability of the partnered force. However, these patrols require close coordination and could present operational security risks. Units should anticipate that initial efforts at joint patrols, which are further discussed in 26—*Conduct Combined Operations*, will experience challenges that should be identified in after-action reviews and improved upon with persistent efforts. It will be important to obtain a host-state perspective on both the challenges and areas for improvement. Interpreters and female integration are likely to be key areas that, with due attention, can greatly improve the effectiveness of patrols.

CONDUCT OF PATROLS

a. Patrols should observe and report on the situational variables described in Chapter 2 as they apply to PoC. They should interact with the local population to obtain an accurate understanding of their perspectives. Patrol members should behave professionally and with high discipline standards regarding their appearance, demeanor, actions, and speech. In some situations it may be appropriate to present an aggressive or intimidating posture, whereas in other cases patrols should appear more benign and relaxed. Either posture will convey underlying messages and could create second-order effects, some of which are undesirable. At all times, patrols should treat civilians respectfully and refrain from actions that could harm them (such as unnecessarily aggressive driving that could cause accidents, harm pedestrians, or generate resentment). In virtually all cases, some patrol members should be exclusively focused on maintaining security while others are performing other functions such as conversing with the population.

b. PoC issues could arise during patrols, requiring that they be diverted from their original missions. Patrols and their controlling headquarters must be flexible and adjust when circumstances require. For example, a patrol in the general area may be directed to respond to a report of imminent violence against civilians. Following a mission, debriefs should be conducted with the entire patrol to ensure that all possible PoC-related information is gathered.

MOBILE OPERATING BASES

a. Mobile Operating Bases (MOBs) are temporary patrol bases established by military units to support extensive patrolling operations. When a unit is assigned a large area of responsibility that cannot be completely secured through normal patrolling and outposts, companies or platoons can establish MOBs to extend the range and duration of their patrols, thus providing improved security to dispersed civilians. MOBs can also be a useful method to gain the initiative against potential perpetrators.

b. A wide variety of operational concepts can be employed; for example, Figure 3.4 depicts a seven-day operation with a company perimeter adjacent to a village during the first phase; platoon positions around a village during the second phase, and platoon perimeters at different villages during the third phase.

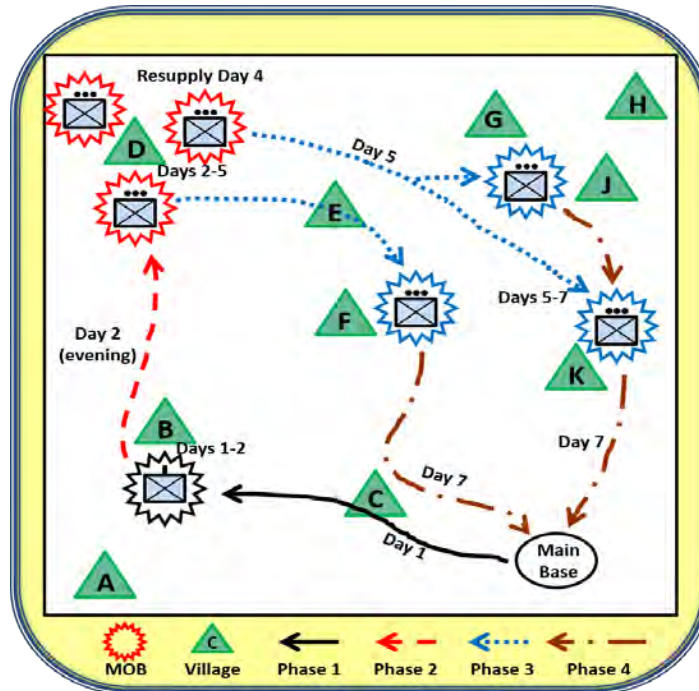

► Figure 3.4: Mobile Operating Bases (MOBs) ◀

c. MOBs require careful planning so that the six operational functions in Figure 3.2 are adequately addressed. Units should develop well-rehearsed priorities of work when they occupy static positions. Depending upon the situation and the nature of the threat, these priorities may include:

- Establish security.
- Position crew-served weapons.
- Assign primary unit and individual fighting positions and sectors of fire.
- Position listening posts, observation posts, and entry point guards.
- Establish communications with higher headquarters and local leadership.
- Prepare and improve fighting positions.
- Assign alternate fighting positions.
- Develop fire support plans, patrol plans, counterattack plans, and other contingency plans (e.g., response to attacks against local civilians).

d. When leaving a patrol base, units should “sterilize” the area so that adversaries will be unable to gather useful intelligence from the location. The military force must also be prepared to exploit unforeseen opportunities that develop as a result of successful MOB activities. Units that are used in MOB efforts may require a short recovery period before they are reemployed.

Task Challenges

Besides the capacity, friction, and fog issues associated with any military operation, the fundamental challenge is the possibility that a patrol encounters a situation that is too big for it to handle, including PoC-related problems. Patrols can be isolated and vulnerable to attack from adversaries. Such situations are more likely when patrols establish a predictable pattern of activity.

After a patrol departs, perpetrators may conduct reprisals against civilians who collaborate with the military unit. During crises, vulnerable civilians may flock to patrols for security, which could overwhelm the unit's ability to provide security or other support.

Task 12: Establish Checkpoints, Guard Posts, and Observation Posts

Task Description

In addition to patrols, military forces establish outposts which include fixed sites such as checkpoints, guard posts, and observation posts to help provide security at critical locations or over a large area. These outposts may be temporary (i.e., operational for a few hours) or relatively permanent in nature and are usually austere. They are normally manned with a small force (squad or platoon) that may reside at the site or be rotated during their daily shifts.

Task Relevance to PoC

Outposts, like patrols, help the military force to establish a presence over a large area or at critical nodes. They provide surveillance, control activity at key areas, monitor vulnerable populations, and impede potential perpetrators. Outposts are an important method to reassure the population and support engagement with local civilians.

How the Task is Accomplished

a. Outposts are normally located at key locations such as hilltops, bridges, major thoroughfares, areas with potentially vulnerable civilians, or critical infrastructure. They can be employed to monitor and secure the area, deny the location to adversaries or impede their operations, control traffic or access, or serve as a base from which to conduct patrols or respond to local incidents that threaten civilians.

b. Outposts require security, communications, resources to accomplish their purpose, and logistics. Capabilities in these areas should improve over time. Security is always a concern because outposts are often small, isolated elements that can be observed and targeted by adversaries. Security measures include barrier materials, fighting positions, protective shelters, day and night observation devices, a self-defense plan that is rehearsed frequently, an internal quick reaction force, direct and indirect fire plans, local reconnaissance and surveillance patrols, and variation of operating patterns.

c. Communications must be maintained with higher headquarters, other units, and supporting units such as artillery. Communications should be robust and as secure and redundant as possible, potentially including cell phones and the internet. Often, outposts should also have communications with local actors such as government officials, security forces, or humanitarian workers. This can facilitate rapid situational awareness and response if, for example, civilians face imminent threat from perpetrators.

d. Units in outposts may need to be supplemented by additional specialists or equipment to perform their missions more effectively. Examples include interpreters, high-powered optics for

observation, special crew-served weapons systems such as mortars or anti-tank missiles, female augmentation, civil affairs personnel, or military working dogs and handlers to identify explosives. In some cases, it may be appropriate to obtain this augmentation from civilian organizations or the host state's military.

e. Outposts will require logistics, and these needs increase when outposts are more permanent in nature. These logistical considerations are discussed further in Task 22—*Provide Administration and Logistics*, but significant considerations include potable water, rations, facilities, electrical power, medical support, maintenance, billeting, and resupply. Logistical arrangements for outposts may have to account for additional demands such as temporary augmentation or displaced civilians who may seek protection or other support. Outposts are frequently occupied by rotating units, and provisions will be required for the accountability and condition of the outpost's assets (especially facilities, equipment, and supplies) to ensure that outgoing units do not pilfer or abuse them. As a rule, outgoing units should leave the outpost in better condition than when they arrived.

f. Checkpoints are frequently used to control traffic, particularly along major thoroughfares and at key nodes such as bridges. This can be useful to monitor civilian movements and interdict adversaries. They may be hastily established for limited periods of time or be more enduring. Figure 3.5 depicts a sample schematic for a squad-sized checkpoint, which includes provisions for controlling traffic, security (against potential threats that enter the perimeter as well as external threats), and contained searches. Checkpoints require interpreters, and it may be appropriate to include female soldiers to question or search women. It is normally advisable to have host-state security forces involved in checkpoint operations as early as possible. As checkpoints provide much of the direct contact that military forces have with the population, it is vital that leaders ensure soldiers conduct themselves professionally and do not abuse or extort civilians.

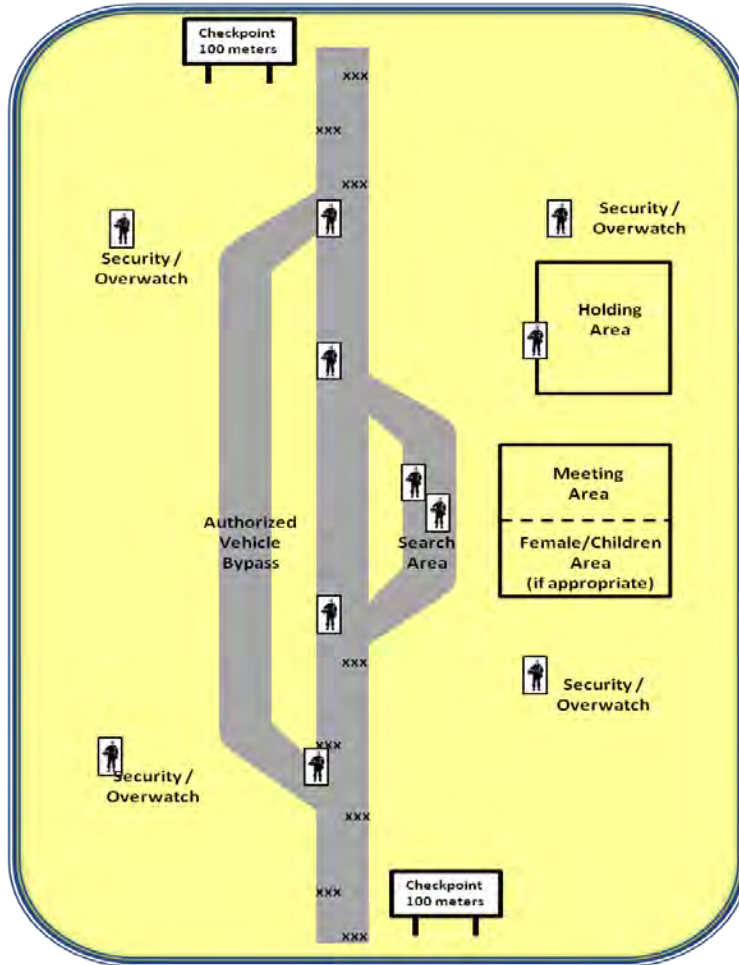

► Figure 3.5: Example Checkpoint ◀

g. Guard posts and observation posts often form part of a network to monitor or secure a large area, such as a buffer zone between perpetrators and potential victims. Outposts may have infrequent contact with civilians, although they should be prepared to respond to situations when civilians approach them for security or other support, or to report incidents.

Task Challenges

Small outposts are vulnerable to attack and create logistical and command and control burdens. Outpost operations can quickly become mundane for the soldiers performing them, potentially resulting in complacency and a lack of initiative. If patrolling does not supplement the outposts, they may have limited impact on the wider area of operations. For example, adversaries may quickly learn to bypass known checkpoints.

Task 13: Conduct Cordon and Search Operations

Task Description

Cordon and search operations are conducted to isolate an area and conduct systematic activities to remove a threat or achieve other objectives.

Task Relevance to PoC

Cordon and search is a useful method to locate concealed adversaries, including those who perpetrate violence against civilians. Cordon and search operations may also be conducted to locate weapons caches, evidence (such as mass graves), perpetrators who are attempting to escape justice, or vulnerable civilians in need of assistance. These missions may often be conducted to accomplish other objectives, and units should refrain from causing inadvertent civilian harm in such situations.

How the Task is Accomplished

a. When establishing and maintaining security in an operational area, units often conduct cordon and search operations to neutralize adversaries or seize their resources, or for other purposes such as to locate vulnerable civilians. These operations may be intelligence-driven, as part of a systematic effort to demonstrate presence or improve situational understanding, or as an early stage of a longer operation in a particular area. They may occur in response to reports about imminent threats against civilians; for example, if perpetrators are reported to be organizing at the objective area. These operations may also be conducted at locations that have experienced mass atrocities or other violence against civilians. These operations may or may not be aggressive in nature, and can provide opportunities to engage with local leaders and communities.

b. In many respects, cordon and search operations are planned and conducted like raids, except that combat tasks such as fire support and assaults are not included as part of the basic plan (they may, however, be addressed as contingencies). Although they are usually conducted against small or irregular adversaries that are not likely to engage in direct combat, during cordon and search operations the participating units must be large enough to contain the area of interest, search it adequately, and defend itself against potential threats.

c. Cordon and search operations may be conducted by any echelon, though in most cases when battalions or brigades conduct these operations they will actually be a series of efforts by companies or platoons. The objective area could be a building, a village, a hill, or any other area. Adversaries may attempt to conceal themselves in populated areas or in remote terrain that is not easily accessible.

ORGANIZATION AND CONDUCT

a. At a minimum, the force consists of a security element that establishes the cordon and a search element(s) that conducts the actual search of the objective area. The security element should

be able to control entry or exit from the objective area through observation or its physical presence. It is also possible that a support element is needed to assist the search teams with close-in security, take custody of detainees or evidence, conduct interrogations, dispose of explosives, exploit sites discovered by search teams, or perform other functions. Finally, the command and control (C2) element provides mission command and potentially engages with local leaders. This element may be collocated with one of the other elements. Figure 3.6 depicts a representative cordon and search concept.

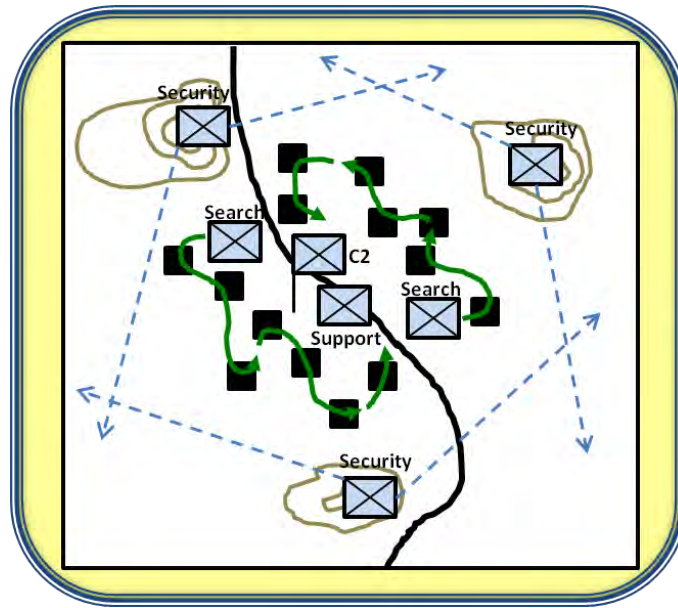

► **Figure 3.6: Cordon and Search** ◀

b. If possible, approach routes should be carefully selected to avoid alerting adversaries that a cordon and search operation is about to occur in an area; it may be advisable to use multiple converging routes. The security element quickly establishes the cordon to prevent suspects from fleeing and to secure the operation from external threats. The security element may also control subsequent access into the objective area. Depending upon the size of the perimeter and available observation, the security element may need to conduct patrols to secure the site effectively. Once the cordon is established, other elements can move into the objective area. It may be necessary to provide instructions to the population (e.g., stay in homes or assemble in a central location).

c. Search teams should be assigned objectives and work methodically, with due consideration to potential security threats (e.g., trip wires). They should treat personnel in the objective area respectfully, but firmly if necessary. In some situations, it would be appropriate to knock on doors, request permission to enter, and conduct searches in conjunction with local officials. In any event, search teams should not antagonize the population by humiliating them or by damaging or stealing their property. While in the majority of cases it is advisable to include females, in some cultures it is *essential* to have females conduct searches; therefore, force composition decisions should be made considering the local gender norms and cultural dynamics.

Task Challenges

Challenges include establishing an effective linkage between intelligence and operations. Good intelligence is required for successful cordon and search operations, which in turn can provide additional information that should be acted upon as rapidly as possible. Units will have to protect sources and civilians who cooperate with units during these operations. These operations will generally be more effective if host-state security forces play a prominent role. However, such integration may undermine operations security and can be counterproductive if these forces are not respectful of human rights. Operations should be conducted in a manner that does not reduce the population's support or result in civilian harm; however, these missions can quickly become violent when adversaries are located.

Task 14: Neutralize or Defeat Perpetrators

Task Description

Whether engaged in armed conflict or conducting “robust peacekeeping,”⁴⁴ military forces at any echelon may be required to conduct combat operations against perpetrators or other adversaries to defend against or respond to their attacks against the force or civilians, preempt future attacks, or eliminate their capabilities to do so. The objective is often to make the adversary comply with the military force's objectives, and not necessarily to destroy it.

Task Relevance to PoC

Offensive and defensive actions may be necessary to stop perpetrators who are clear threats to the military force, its partners, or civilians. Combat operations may be necessary to gain the initiative against perpetrators. By demonstrating that it has both the will and the capability to defeat adversaries, the military force may establish the credibility required to deter future aggressive behavior by the perpetrators. Combat operations must be conducted judiciously, with due avoidance of inadvertent civilian harm.

How the Task is Accomplished

a. In some cases offensive operations will already fall within standing guidance to defeat a hostile adversary. In others, specific approval for such missions will be required. ROE should account for either case. PoC defensive measures may also be required, such as the use of air and missile defense and counterfire assets to protect population centers. Operations will be based upon

⁴⁴ “Robust peacekeeping” is discussed in the Brahimi and New Horizon Reports and its characteristics are further reinforced in the High Level Independent Panel on Peace Operations (HIPPO) Report. Robust peacekeeping includes confident and credible military and police postures along with a willingness to use force on a limited basis to defend the mandate. See the United Nations, Report of the Panel on United Nations Peace Operations (A/55/305—S/2000/809) (New York: United Nations, 2000), 9-11; the United Nations, *A New Partnership Agenda: Charting a New Horizon for UN Peacekeeping* (New York: UN Department of Peacekeeping Operations and Department of Field Support, 2009), 21-22; and *Uniting Our Strengths for Peace—Politics Partnership and People: Report of the High-Level Independent Panel on United Nations Peace Operations* (New York: The United Nations, 16 June 2015).

indicators of imminent threat to the force or to civilians, and may resemble a UN model which includes the following four phases:⁴⁵

- **Phase 1: Assurance and Prevention.** The threat of hostile activity is present, but low. This phase includes generally passive deterrent measures such as a robust posture, presence patrols, community liaison, checkpoints, and information activities.
- **Phase 2: Pre-emption.** The threat of hostile activity is highly probable. This phase includes active measures, such as the tactical deployment of forces to key locations, to preclude or gain advantage over an adversary before it can commit a violent act.
- **Phase 3: Response.** Hostilities are occurring or imminent. This phase involves the proportional use of force to neutralize or defeat an adversary and other activities to respond to acts of violence.
- **Phase 4: Consolidation.** The hostile threat has subsided. This phase includes activities to restore peace and order and post-conflict management to prevent its recurrence or deny adversaries the ability to restore fighting capacity.

b. Operations may include combat patrols, ambushes, raids, movements to contact, hasty or deliberate attacks, and strikes by indirect fire systems or aircraft, including helicopter gunships. Each of the operating functions discussed earlier in this chapter are vital for such efforts, and commanders should strive to mitigate possible negative consequences such as an escalation of conflict or adversary retribution against vulnerable civilians. Units in peace operations will be more limited in terms of their available methods and the scope of their operations.

c. The best form of mitigation may well be to strike hard at the adversaries’ critical vulnerabilities and not allow them the opportunity to recover. It may be impossible for the military force to attack every adversary that is conducting a direct act against civilians, and it may also be necessary to attack targets further up the “threat chain,” such as logistical or command and control nodes, to defeat adversaries (see Figure 3.7). Military units should carefully consider how much of the “threat chain” should be targeted or otherwise influenced; while expansion of the target set may provide short-term military benefit, it could also have adverse political impact.

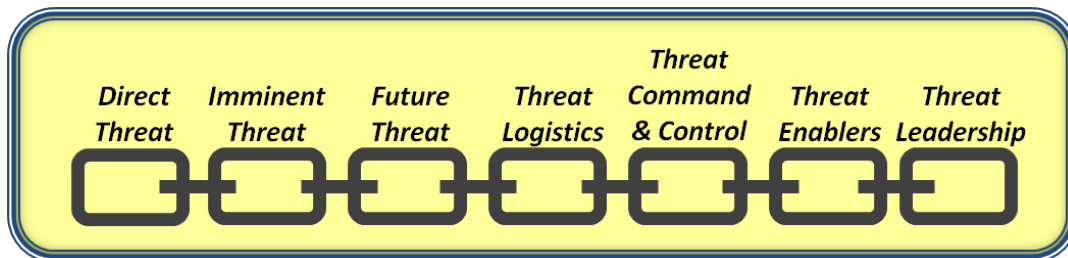

► **Figure 3.7: Threat Chain** ◀

⁴⁵ Based on the UN Tactical Decision and Response Model as described in United Nations, *DPKO/DFS Guidelines: Use of Force by Military Components in United Nations Peacekeeping Operations* (New York: United Nations Department of Peacekeeping Operations and Department of Field Support, 1 February 2017), 13-15.

d. Offensive operations should be carefully planned and conducted in accordance with LOAC/IHL and the rules of engagement to avoid civilian harm, including collateral damage. Civilians could be located with or close to intended targets, and in accordance with the principle of proportionality their potential harm must be balanced against the military necessity of conducting the attack. In some cases, these civilians may be present against their will, and provisions may also be required for the possibility that perpetrator ranks include child soldiers who should be protected as much as possible.

e. When they are available, special operations forces or other clandestine methods can be effective to neutralize or defeat some adversaries, though the integration of these assets with conventional forces requires careful planning. Commanders should include nonlethal means such as information activities and electronic warfare in their efforts to neutralize or defeat their adversaries. Information activities are discussed further in Task 31—*Conduct Information Activities*.

f. Defensive measures such as the deployment of air and missile defense and counterfire units to protect population centers may require that these limited assets are not used to protect other potential targets such as bases, infrastructure nodes, and deployed military units.

Task Challenges

a. Combat operations, especially those that occur outside of strictly self-defense situations, could result in unintended escalation or inadvertent civilian harm. Even if combat operations are largely successful, perpetrators could elect to retaliate against vulnerable civilians if the military force does not have the resources to secure the entire area of operations.

b. Official host-state organizations, such as security forces and state-sponsored paramilitary organizations and militias, may in fact be perpetrators that harm civilians. Units may have to ensure that attacking such organizations is within their ROE and political guidance. Combat actions directed against any host-state actor may result in undesired effects, such as conflict escalation, adverse effects on public opinion, or withdrawal of any host-state consent for the mission. However, failure to enforce a mandate to protect civilians from host-state perpetrators may result in larger problems.

c. Positioning military units close to civilian populations may be intended to protect them, but could also make civilians vulnerable to collateral damage if the military assets are attacked. The deployment of protection assets such as air and missile defense units may result in unrealistic expectations that these assets will be able to provide civilian populations perfect immunity from attack.

Task 15: Secure Vulnerable Civilians

Task Description

Military forces may establish safe areas around vulnerable populations, such as DP camps. Units may also conduct limited, short duration activities such as providing escorts for humanitarian convoys.

Task Relevance to PoC

Military forces may be deployed to provide direct security for vulnerable civilians. Alternatively, as occurred with the UN Mission in South Sudan (UNMISS), vulnerable civilians may move towards and seek protection from military forces at the latter's locations. Safe areas may be appropriate when the military's strength is limited and it is unable to provide adequate security throughout an entire region, especially during the early stages of an operation. The force provides rapid and direct protection for large numbers of vulnerable civilians. By providing security for humanitarians and other protection actors, the military can help them obtain their needed access to vulnerable civilians.

How the Task is Accomplished

a. Units deploy around population concentrations that are likely to be targeted by perpetrators, including DP camps or towns that are in close proximity to perpetrators, as depicted in Figure 3.8. Units provide local security for such locations as appropriate, and if capable expand their presence throughout larger sectors.

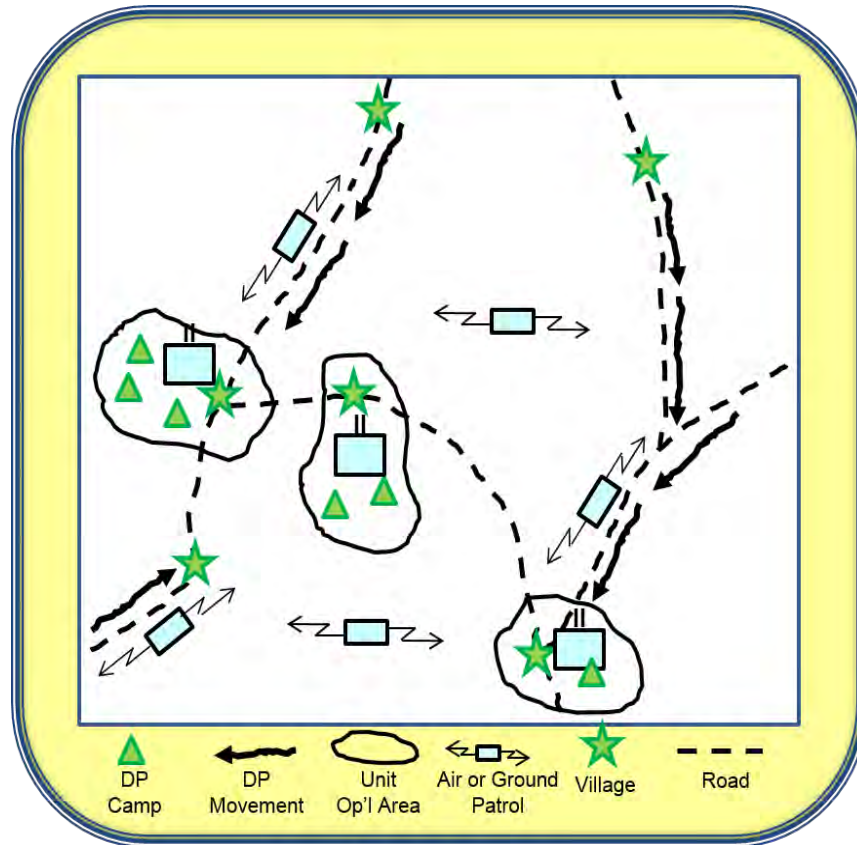

► Figure 3.8: Safe Areas ◀

b. Migration to these safe havens by other civilians should be anticipated and, in some cases, even encouraged. This may require that military forces also provide security and support along likely migration routes. As DPs collect around military forces for protection, units must be prepared to provide or enable security (with such measures as lighting and patrols), humanitarian assistance, and DP camp administration. In some situations, safe havens may be established in neighboring countries.

c. Units adopt a generally defensive posture, focusing on providing local defense and patrolling to remove threats of direct and indirect fires. Intelligence assets and fires are focused on perpetrators that may be gathering to attack military units or the safe areas, and may also retaliate for perpetrator attacks that have already occurred.⁴⁶

Task Challenges

a. Military forces are only able to secure some concentrations of vulnerable civilians and are unlikely to protect civilians outside of their immediate areas. The required security effort may consume a significant portion of the military's capability, rendering it unable to conduct other tasks, such as extensive area patrolling. Safe areas may become long-term DP sites and thus may support any perpetrator efforts to conduct ethnic cleansing. Large concentrations of DPs could be

⁴⁶ Derived from Sewall, Raymond, and Chin, *The MARO Military Planning Handbook*, 77-80.

convenient targets for future attacks on civilians, particularly if perpetrator groups are not under any direct pressure. As occurred at Srebrenica in 1995, perpetrators could deliberately prepare an operation to overmatch intervening forces and attack concentrations of victims. Safe areas can create difficult health and other social issues, and could be used sanctuaries for belligerents. Although military logistics are partially facilitated because units are concentrated in a few locations, lines of communication through unsecured areas may be vulnerable, and extensive resources to build and sustain DP camps will have to be provided by the military or NGOs.

Task 16: Evacuate Vulnerable Civilians

Task Description

Military forces may be required to evacuate civilians from conflict areas or other situations in which they are at risk. The evacuation could be for a temporary or extended period of time.

Task Relevance to PoC

Evacuation operations are normally appropriate for relatively small numbers of civilians that can be removed from a harmful situation. Given sufficient time and resources to conduct the evacuation, large numbers of civilians can be evacuated. Considerations discussed in this task may also apply when large numbers of civilians seek security or other support from military units.

How the Task is Accomplished

a. The evacuees could include all civilians in the area or members of a particular group (such as humanitarian workers, third-country nationals, or members of an ethnic group). An operation may entail ground evacuation to a safe haven several kilometers away, or it may be a complex endeavor using multiple modes of transportation to other countries. In some cases, all evacuees will be transported at once, while in others small groups will have to be shuttled because of a shortage of available transportation. Diplomatic negotiations, such as a temporary ceasefire, may provide the time and conditions required to evacuate large numbers of personnel. An evacuation could occur under hostile or permissive circumstances, and may be structured in the following phases:

- **Phase I—Preparatory Operations.** Intelligence is gathered; the evacuation force and supporting logistics are assembled and prepared; planning, training, and rehearsals are conducted; notifications are made; other administrative preparations are accomplished.
- **Phase II—Insertion Operations.** The evacuation force is deployed (including forcible entry if necessary, as well as other operations to shape the environment); necessary sites are secured.
- **Phase III—Evacuation Operations.** Evacuees are assembled, marshaled, and transported to an intermediate staging base (ISB) and/or a final reception center at a safe haven.

- **Phase IV—Withdrawal.** The evacuation force redeploys, if its withdrawal does not occur along with the last group of evacuees.

b. Figure 3.9 illustrates a potential evacuee flow. A military force may be responsible for the overall operation, or other organizations may be in control once evacuees have departed from the risk area. An ISB may be appropriate to stage units and evacuation resources or to remove evacuees from immediate risk and free transportation assets to return quickly for more passengers. Civilian organizations such as national embassies or international organizations may also be involved in an evacuation, and responsibilities, authorities, and command relations should be clearly understood beforehand. These civilian organizations will often determine who should be evacuated.

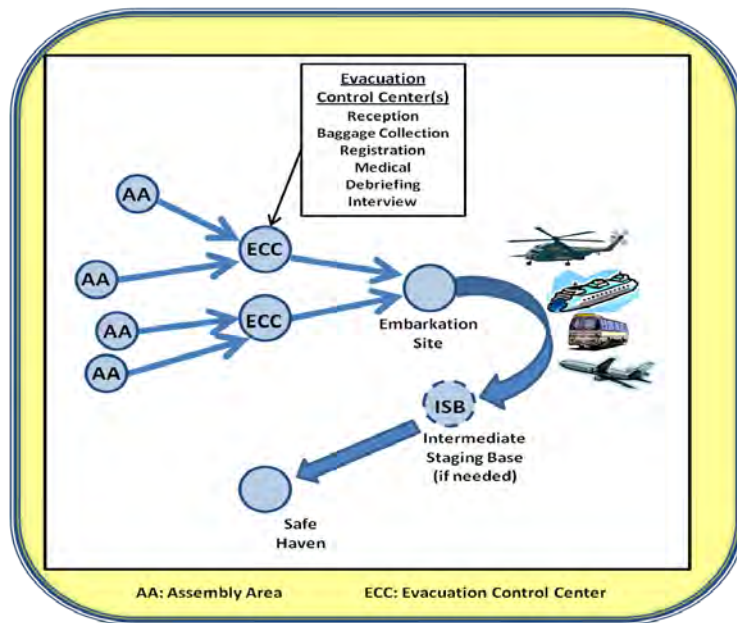

► **Figure 3.9: Evacuation of Vulnerable Civilians** ◀

Subordinate military units are assigned specific tasks to support the operation, such as to provide C2 at a location, secure and/or operate key nodes (Assembly Areas, Evacuation Control Centers, and Embarkation Sites), escort evacuees, transport evacuees, provide on-call fire support, or other functions. Commanders should anticipate that evacuees will require medical treatment and essentials such as food or water. Reserve capacity should be planned for each stage of the operation, to include back-up transportation assets. Military forces may be responsible for reception at final safe havens, though this function could also be the responsibility of a civilian agency.

Task Challenges

While possibly removing civilians from an immediate threat, an evacuation can result in large numbers of displaced persons with subsequent humanitarian and resettlement challenges. Civilians could be vulnerable as they leave their homes and until they reach a safe haven. An evacuation may indirectly support the goals of perpetrators, if these goals primarily include “ethnic cleansing”

rather than the extermination of the victims. In some cases, civilians will resist efforts to evacuate them.

Task 17: Conduct Interposition Operations

Task Description

Interposition operations (also known as “buffer zones”) establish designated areas between belligerents that are intended to prevent conflict. They may include boundaries and “demilitarized zones (DMZs)” that have restrictions on the types of military forces and their activities. Interposition operations are integral to the “Separation” operational approach presented at the beginning of this chapter.

Task Relevance to PoC

Interposition operations can be useful to separate vulnerable civilians from potential perpetrators who threaten them. In some cases, a buffer zone may be established between clearly-defined population groups that might otherwise be in conflict.

How the Task is Accomplished

a. Interposition operations or other means of separation may be consensual; that is, they may be part of a peace agreement or cease-fire arrangement. In other cases, military forces may impose a buffer zone as an operational concept to shield vulnerable civilians from potential perpetrators. Ideally, interposition operations should be sufficiently robust that adversaries cannot turn their flanks, defeat them with offensive operations, infiltrate through them, or attack over them with indirect fires or airstrikes. Figure 3.10 illustrates a representative concept for an interposition operation.

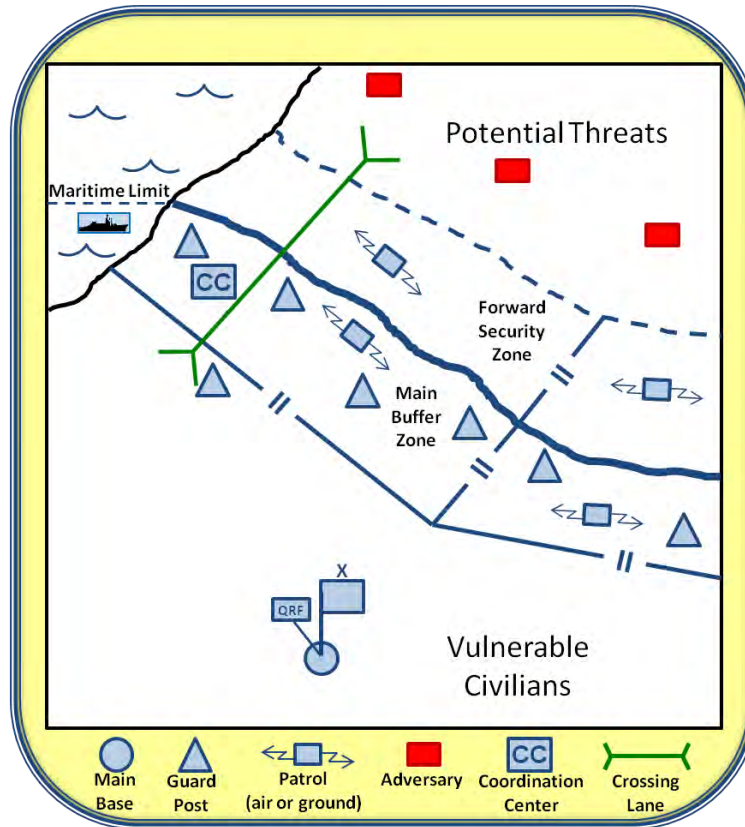

► **Figure 3.10: Interposition Operations** ◀

b. Interposition operations largely consist of guard posts and patrols, and may be established along a political boundary or prominent geographical feature such as a river. They may have a depth of two kilometers, but this will depend upon terrain, negotiated arrangements, or other considerations. The zones should be anchored at a coastline or other feature that does not permit easy bypass; if this is not possible ground and aerial patrols should secure the open flank(s). The main zone may be supplemented with a forward security zone, and crossing lanes may exist to permit controlled traffic between the areas separated by the zone.

c. A buffer zone may include civilian inhabitants, which could necessitate unique accountability, control, and security arrangements. It is possible that individuals attempting to cross the buffer zone may not have hostile intent, but could be civilians who are motivated by economic, political, or family concerns. Rules of engagement will have to be carefully designed and implemented to balance such possibilities with the potential threat posed to the military force or vulnerable civilians.

d. Minefields can be effective methods to help secure buffer zones in some armed conflict situations, but these pose an enduring hazard to civilians and are banned by many nations. In some cases, buffer zones may be able to take into account minefields and other barrier systems that already exist.

Task Challenges

As an operational concept, an interposition operation has potential drawbacks. It will not by itself protect any vulnerable civilians that are located beyond the zone, and military forces could find themselves caught between belligerents if any peace arrangements break down. Additionally, interposition operations could easily result in an undesirable long-term political division and an extended peace operation.

Task 18: Mitigate Civilian Casualties

Task Description

Civilian casualty mitigation includes measures to avoid or minimize unnecessary civilian casualties and reduce the adverse impact of those that occur. The primary focus is on casualties that may be caused by military operations, including direct and indirect fires and vehicle accidents.

Task Relevance to PoC

Causing civilian casualties is unlawful unless it occurs under circumstances permitted by LOAC/IHL. Civilians may be at risk any time military force is used to achieve political objectives, but civilian casualties undermine the military force's legitimacy and can jeopardize the mission. Even if a military action is otherwise permissible, it may be prudent not to conduct the action because of the possibility of civilian casualties.

How the Task is Accomplished

a. Civilian casualty mitigation includes measures that can be taken before and after a particular incident involving civilian casualties. Units should conduct advance training on respect for civilians, cultural awareness, and civilian casualty mitigation, and leader emphasis is particularly important to set positive conditions. Soldiers at all levels should consider civilian casualties during planning and employment, to include when supporting fires are planned or when a soldier decides to engage a target.

b. Commanders should quickly address civilian casualty incidents and take them seriously. Effective relationships that have been previously established with key actors can help minimize additional damage. Response measures are discussed in Task 3-19—*Respond to Reported Incidents of Civilian Harm*.⁴⁷

Task Challenges

Military leaders must ensure that civilian casualty mitigation is a high priority, despite other mission requirements and force protection concerns. Leaders must openly address any incidents that occur and avoid any tendency to deny mistakes. On the other hand, it will be important to distinguish factual circumstances from inaccurate or deceitful reports.

⁴⁷ For more information, see Chapter 5 of *ATP 3-07.6 Protection of Civilians* (Washington, DC: Headquarters, Department of the U.S. Army, October 2015).

Task 19: Respond to Reported Incidents of Civilian Harm

Task Description

Military units must be able to recognize possible incidents of civilian harm, conduct inquiries or investigations, analyze imperfect information to ascertain facts and trends, and take appropriate action when they receive reports that civilians have been harmed.

Task Relevance to PoC

The military force should anticipate that, despite its best efforts to protect civilians, serious incidents of civilian harm will occur. These could result from unit actions, deliberate atrocities committed by perpetrators, or the result of natural disasters. Consistent demonstration of proficiency in this task will enhance the military force's legitimacy and build trust within the civilian population and other actors.

How the Task is Accomplished

a. The military force's responsibility and appropriate response may vary with different circumstances, but generally units should assess, respond to, and learn from these incidents. Response will usually be more effective when constructive relationships have been established with the civilian population and host-state leaders. The military force may elect to establish PoC tracking cells at appropriate echelons to monitor incidents of civilian harm and manage responses.

b. **Assess.** Assessment includes understanding that an incident may have occurred and gauging the scope and circumstances of the incident. Reports of a suspected incident may originate from a subordinate unit, a local civilian, a humanitarian organization, the media, or other sources. The information may be in reference to a recent incident, a previous occurrence (e.g., a mass grave site may be reported), or an ongoing situation (for example, child abuse in an orphanage).

(1) Reports may be provided in a variety of ways; for example, a civilian may discretely inform a sentry who is guarding a base entrance. All soldiers at any level must relay such information to appropriate individuals and organizations in the chain of command. This reporting will be more likely if allegations of civilian harm are included as part of the CCIR.

(2) Reported incidents should be investigated to determine credibility and accuracy and to gather more information. Many reports may be inaccurate or deliberately falsified. The military force should check with other actors that might have information, such as units in the area, host-state security forces, or local leaders. Based upon the probability that reports are true (and/or the level of concern regarding the incident), an initial inquiry or investigation may be conducted by a formally assigned officer. This inquiry or investigation should be completed within a matter of days. A lengthier investigation may subsequently be necessary if extensive forensics are required, criminal charges are being considered, or if a joint investigation should be conducted with other organizations. Any inquiry or investigation should be impartial and credible. Witnesses may require special considerations, such as protection from retribution and careful handling if they too are victims.

c. **Respond.** Response includes actions taken as a result of an incident report and to the incident itself. These could include stopping the harmful situation, treatment of victims, information activities, key leader engagement, actions against perpetrators, or the making of amends.

(1) Some responses will occur immediately following an incident, while others could occur long afterwards. Information activities and key leader engagement will be continuous efforts to share information, quell rumors, and assure different audiences and actors that the military force is taking appropriate measures.

(2) The making of amends may include monetary compensation or *ex gratia* payments, apologies, truth and justice commissions, and dignifying gestures such as ceremonies, memorials, and community projects in honor of victims. Higher level commands must carefully prescribe procedures and standards for any monetary disbursement to ensure that units act consistently and legally, and to prevent abuse of any funds. Support arrangements may be required for women, children, and elderly survivors who have lost the primary breadwinners in their families.

(3) Mass casualty situations will require mobilization of civilian-military resources to treat wounded, conduct burials and graves registration, establish security, provide essential goods and services to survivors, conduct investigations, and cope with a wide range of other activities such as media requests and visits by political authorities. It will be important to establish on-site command and control with a senior officer who can ensure effective cooperation with local and international civilian and police officials. Military forces may be critical to provide security, communications, transportation, and logistics to other organizations until they are established and fully operational. Higher headquarters must proactively provide any required support to the on-site commander, to include conducting the external coordination required to obtain such support.

d. **Learn.** Military forces must learn and adapt quickly to protect civilians in complex environments. Lessons can be obtained from “near miss” situations as well as incidents in which civilians were actually harmed. Units should collect and analyze PoC-related information (including intelligence and inquiry or investigation reports) and disseminate insights to higher, lower, and adjacent organizations. Useful information can also be obtained from nonmilitary actors, including the civilian population. This learning process can be facilitated and be made more rigorous with a staff section that has clear responsibility for monitoring PoC. However, as with most issues, leader emphasis is the critical variable. Command climates should foster trust and transparency, while maintaining accountability and a unit ethos that continually strives for improvement.

Task Challenges

A major challenge with this task will be determining which reports are true and which are false or inaccurate. Deceitful reports may be generated by adversaries seeking to discredit the military force or its partners, or by “victims” who are hoping for monetary compensation. Another challenge will be to convince different audiences that any military inquiries or investigations are truthful, which will require effective information activities.

Task 20: Protect the Force

Task Description

Force protection includes active measures directed against adversary capabilities, passive measures that make friendly assets difficult to locate or strike, measures to prevent fratricide, and protective measures to reduce the risk of accidents, health threats, and environmental threats. Military units must protect themselves from a variety of threats, including attacks by adversaries or other spoilers. These attacks may be motivated by revenge, a desire to undermine peace, or to cause casualties that reduce political support for the mission in troop contributing countries.

Task Relevance to PoC

Effective force protection helps preserve the capability to achieve mission objectives, including PoC. However, concern about force protection may result in a cautious posture that ultimately reduces operational effectiveness and inhibits PoC. Additionally, soldiers who focus on force protection may be prone to adopt a “shoot first and ask questions later” approach that jeopardizes civilians.

How the Task is Accomplished

a. Small units, such as patrols or guard posts that are required to provide security over widespread areas, may be particularly vulnerable. Major bases, however, are also susceptible to large-scale attacks, indirect fires, or attacks from the inside. Such attacks are often deliberately planned and follow careful surveillance that identifies weaknesses in base routines. The concept of Presence-Posture-Profile as discussed at the beginning of this chapter is relevant to force protection.

b. Units will have to balance force protection concerns with operational requirements that include PoC. Stringent force protection measures can create resentment in the population, which can contribute to future insecurity and greater long-term threat to the unit. ROE must be developed that clearly articulate when units may take action against hostile threats and in self-defense; however, they must be judiciously applied to prevent inadvertent civilian harm. Soldiers should be aware of and trained in nonlethal measures to warn off civilians who may be perceived as potential threats. These may include warning signs, verbal warnings, the use of lights and lasers, and warning shots.

c. Good intelligence is particularly important for force protection, and this is often best achieved through reliable host-state civilian and military sources that support the unit. This, in turn, is facilitated when the military force can demonstrate that it is able to protect the population. These sources are also critical to identify and locate adversaries who have attacked military forces and their partners.

d. Force protection also includes preventive medicine, procurement of water and food from safe sources, and accident prevention. Accident prevention is likely to be a particular concern for leaders, including vehicle accidents that are caused by bad road conditions or poor driving habits

of the host-state population or military personnel. Command emphasis may be required to ensure that military drivers operate their vehicles safely, especially in congested areas and when pedestrians are present.

Task Challenges

The major challenge for the military force is to achieve an appropriate balance between protecting the force and other operational requirements. Inadequate force protection may result in casualties that weaken operational capability (thus reducing the ability to protect civilians) and can hurt also morale and political support for the mission. After conducting successful attacks against the military force, adversaries could be emboldened to conduct further actions, and other actors may be inspired to emulate them.

Task 21: Provide Command and Control

Task Description

As discussed earlier in this chapter, command and control (C2) is one of the six primary operational functions for military forces. In addition to such traditional topics as command relationships (between higher, lower, supporting, supported, and partnered forces), networks and other communications systems, and guiding an effective decision cycle (observe-orient-decide-act), C2 also includes leadership and nontraditional topics such as comprehensive engagement with a variety of actors and information activities. Comprehensive engagement is addressed in Chapter 4, and information activities are discussed in Task 31—*Conduct Information Activities*.

Task Relevance to PoC

While C2 will seldom be uniquely related to PoC, poor C2 can be a major reason why a PoC catastrophe occurs. C2 enables the military force to adhere to the three PoC fundamentals and conduct all subordinate PoC tasks effectively. PoC must be emphasized within command channels and as leaders engage with other actors. A responsive C2 apparatus is critical to provide useful guidance when unforeseen PoC issues develop. In the absence of such guidance or the necessary time to obtain it, leaders must exercise the initiative required to address civilian vulnerabilities and threats.

How the Task is Accomplished

a. Military forces can be organized by service or component, normal unit chain of command, function, sector, mission/task, nation or a combination of these factors (see Figure 3.11). Similar options exist at all military echelons; for example, a company-level raid could be organized into security, assault, and support elements. The latitude to structure a military force depends upon the authorities that are given to the common commander. In some cases, such authorities are limited; for example, a commander may only have temporary operational control of a subordinate unit. Units in multinational forces, such as international peacekeeping missions, will normally retain

some level of responsiveness to their respective national authorities, who may impose *caveats* on how these units can be employed.⁴⁸

b. In the absence of formal subordination, inter-organizational relationships sometimes involve “supporting” organizations enabling a “supported” organization, even if a common authority does not exist. For example, a military force may be a supporting organization to local host-state police forces (and *vice versa*), or an evacuation force may be a supporting organization to a civilian agency. In such situations, it is important for supported organizations to identify the tasks expected of the supporting organizations and for both agencies to implement effective liaison arrangements.

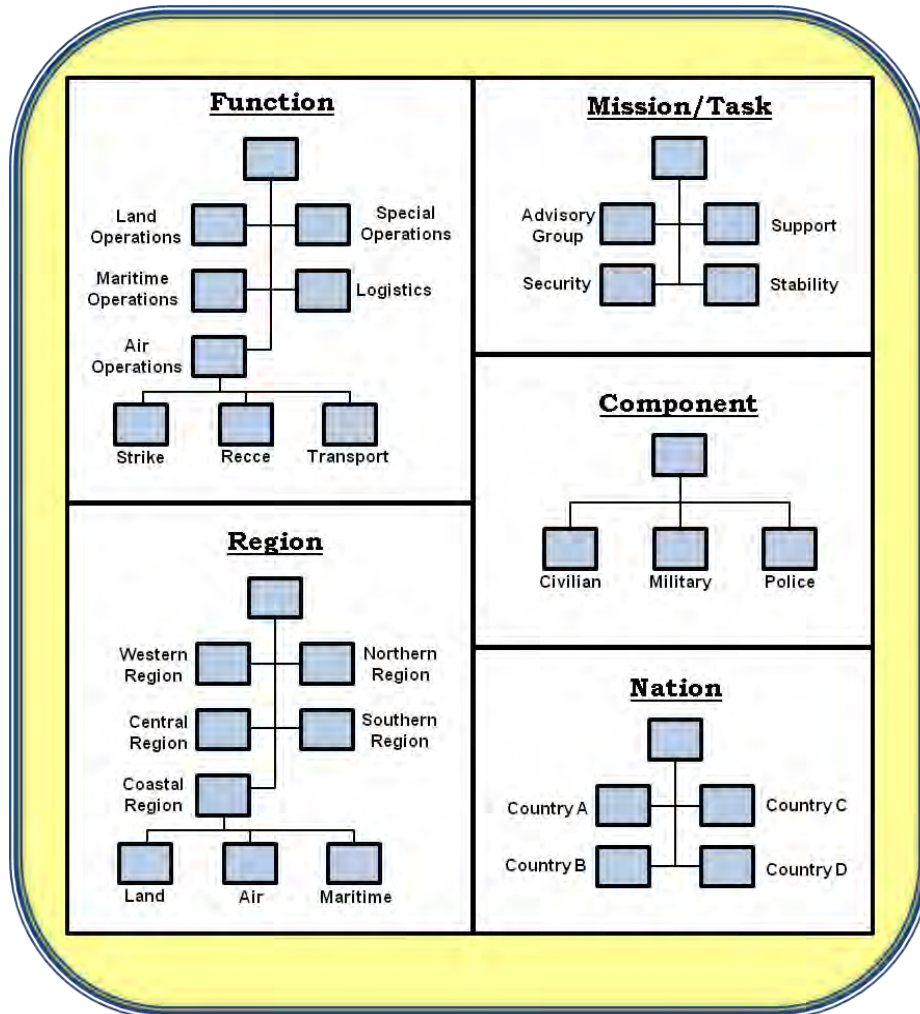

► **Figure 3.11: Command Organizations** ◀

c. C2 includes leadership, which is often the most important variable with respect to PoC. Leaders must continually emphasize the importance of minimizing civilian harm to their subordinates and make it clear that PoC is a priority. This is often conveyed in the Commander’s

⁴⁸For information on command and control arrangement of uniformed components of UN peacekeeping operations, see United Nations, *Authority, Command and Control in United Nations Peacekeeping Operations* (New York: Department of Peacekeeping Operations and Department of Field Support, February 2008).

Intent, which should guide the actions of subordinates. Confronted with a complex or ambiguous situation, leaders can either act decisively or remain passive. When PoC is the issue, a commander should intend for his or her subordinate leaders to take the necessary actions to protect civilians.

d. C2 also includes procedures for planning, promulgating orders, and reporting. As discussed earlier, these systemic processes should routinely include PoC as a mainstreamed focus area, to include ensuring that all relevant parties receive and process necessary PoC-related information. C2 also includes the use of liaison officers and telecommunications means such as radios, computer networks, phones, and video-teleconferences. System classification and interoperability with multinational forces and other actors such as host-state organizations can present challenges for effective C2.

e. C2 arrangements should also reflect relationships between civilian, police, and military organizations assigned to a mission. In some cases, these three components will report through their respective chains. In others, multidimensional organizations would be more effective.

Task Challenges

Effective C2 is difficult when vague or multiple lines of authority exist. For example, national governments may impose *caveats* on the military forces they contribute to coalitions or peace operations. A functional relationship will also have to be developed with other partners such as host-state security forces. C2 will have an inherent tension between centralized control and decentralized initiative within a commander's intent. In many situations, military commanders may be directly subordinate to civilian authorities. This may require an adjustment for commanders whose previous experiences have been as subordinates to other military officers.

Task 22: Provide Administration and Logistics

Task Description

One of the six primary operational functions discussed earlier, logistics includes deployment; Reception, Staging, Onward Movement, and Integration (RSOI); basing and facilities (including services); air, sea, and ground lines of communication; supply; maintenance; health service support; explosive ordnance disposal; transportation; field services; general engineering; personnel services such as pay, leaves, religious support, morale and welfare resources, and legal services; contracting support; unit rotations; and the handling of visitors.

Task Relevance to PoC

Administration and logistics enable all military activities and will seldom be specifically related to PoC. However, if this task is inadequately performed it could critically impair the military force's ability to provide PoC. Robust military operations will require extensive logistical support, which could result in a drain on limited infrastructure that is used by other actors such as NGOs, drive up wages and prices, and reduce the availability of already-scarce resources. This can indirectly have a negative impact on civilian welfare. In some emergency situations, the military force's logistical resources may be used to support other actors or to provide essential goods and

services to needy civilians, many of whom may seek security and support from military forces. PoC may impose other unique logistical requirements, such as security lighting for large numbers of displaced personnel.

How the Task is Accomplished

a. The military force must manage the administrative and logistical functions identified above while remembering that their main purpose is to enable units to accomplish their assigned missions. Effective logistical management includes forecasting, prioritization, acquisition, and distribution. Units, especially those in remote areas, will have to carefully control their consumption of limited supplies that are difficult to replenish, including fuel and water. Infrastructure improvements, such as airfields and roads, can expand the military's operational reach while improving access to vulnerable civilians.

b. Soldiers from foreign countries will be susceptible to diseases in the mission area, and themselves could carry diseases that threaten civilians in the host state. Medical personnel should consider appropriate screening and prevention measures. Units should also be careful to avoid unnecessarily environmental pollution by properly disposing of human waste, trash, and used petroleum products.

b. Military forces should develop SOPs for recurring administrative and logistical requirements. One area frequently overlooked is the handling of visitors in a manner that satisfies their requirements but does not interfere excessively with the force's activities. PoC situations are likely to generate interest and visits from a wide array of influential outsiders. Another likely requirement is the transfer of facilities and equipment when rotational units replace each other. For example, when a platoon at an outpost is replaced, it should ensure that the facility is complete, serviceable, and in better condition than when the platoon first arrived. In this way, the new unit can immediately focus on its operational PoC tasks and not be distracted by the need to achieve a minimal standard of living. Units should anticipate challenges with these and other likely situations, establish expectations and standards, and develop effective procedures.

c. SOPs will help achieve efficiency, but even more important is an attitude among logisticians that their primary purpose is to support those who conduct operational missions. Many SOPs will have been developed prior to deployment, but will require modification and new ones will need to be developed to address the current situation. Logistical procedures may have to account for a multinational force with independent chains, and the military force may also have to help develop the logistical capacity of host-state security forces.

d. Pass/liberty policies are often an important aspect of morale and recreation and can affect PoC. Restrictive policies that keep soldiers on bases can result in lower morale and isolation from the local population. However, liberal pass policies can result in altercations with the population, incidents of soldier misbehavior, prostitution and human trafficking, and reduced force protection.

e. Units will have to be prepared for serious incidents such as civilian casualties, accidents, and allegations of misconduct such as cases of sexual exploitation and abuse. Units should be prepared to investigate and report on such incidents and dispose of cases appropriately. This may

require SOPs, specialized training for officers who may be detailed to conduct investigations, and ready access to legal assistance.

Task Challenges

Remote and isolated units in particular must have sufficient resources, but will be at the end of a long distribution chain. Without adequate logistical support, units will be insufficiently resourced and will consequently spend an inordinate amount of effort seeing to their own internal needs and place less emphasis on PoC. With greater capabilities (for example, night vision devices and mobility assets) come expanded logistical demands (batteries, fuel, and maintenance). As the military force becomes more established, its logistical tail will tend to increase, with a growing proportion of its personnel and resources devoted to internal support functions. This can create a force that is largely base-bound and inwardly focused.

Task 23: Integrate Fire Support

Task Description

As discussed earlier, “fire support” is a primary operational function and includes indirect fires from artillery, mortars, naval gunfire, missiles, and rockets; airstrikes from fixed-wing aircraft (including drones); defensive fires such as air and missile defenses; and electronic attack against adversary C2 systems. While direct fires from ground forces and helicopters are inherent in the “movement and maneuver” operational function, many of the considerations discussed in this task apply to them as well.

Task Relevance to PoC

a. Fire support is a vital military capability, and relevant to PoC for two reasons. First, fires can be used to suppress, neutralize, defeat, or destroy perpetrators who threaten or have attacked civilians. Second, fire support assets (including radars and defensive systems such as air defenses) should be employed in such a way that civilians and other unintended targets are not harmed or placed at risk because of their proximity to military targets.

b. In many cases, the use of fires in support of PoC will be restricted because of ROE, a lack of assets, or concern over collateral damage. In other situations, there will be a heavy reliance on the employment of fires because adversaries are easily targeted and because some fires (such as airstrikes) can be delivered from great distances. Using fires can sometimes avoid the need to commit ground units into direct combat, but generally fires are more effective when employed in conjunction with ground maneuver. Unexploded munitions also can pose a hazard to civilians; when feasible, they should be identified and disposed of as soon as possible. The use of fires is governed by LOAC/IHL principles (military necessity, distinction, proportionality, and humanity).

How the Task is Accomplished

a. Three technical fire support considerations are particularly important for PoC.

(1) **Positive Identification.** Accurate intelligence is important, including information about civilians in the target area. Observers, and shooters when they can see the target area (such as members of an aircrew), must be certain as to the target's identity as well as the possible presence of civilians. This may require cross-talk between different elements that individually have incomplete perspectives from their positions. Positive identification should be maintained for as long as possible (i.e., from the time the call-for-fire is made through the impact of munitions).

(2) **Target Location Error.** Although a target may be properly identified as a legitimate threat to be attacked, for a variety of reasons its actual location may be easily misinterpreted (particularly if the observer does not have a global positioning system to determine his/her own position accurately and laser range finders are not available). Because of this, and because indirect weapons systems are inherently imprecise, the initial round is likely to be off target and require adjustment. Observers may be required to err on the side of caution and ensure that any misplaced rounds land a safe distance from civilians.

(3) **Clearance of Fires.** Ground commanders responsible for an area normally have authority over any fires delivered into it. Clearance procedures must take into account the ROE and balance the need for responsive fires with the requirement to not cause undesired effects, such as civilian casualties or destruction of infrastructure. Clearance for certain weapons systems and target locations may be reserved for different echelons. For example, a company commander may be permitted to clear fires for organic mortars when in contact with an adversary, while a battalion commander must personally clear fires for more destructive systems, and a brigade commander must clear any fires within 1000 meters of a populated area.

b. Fires employment can be more effective and accurate with many means including: properly registered weapons; incorporation of meteorological data; calibrated weapons sights; accounting for geographic altitude of the target and firing system; and well-trained crews who calculate firing data properly, use correct charges, and orient guns accurately.

Task Challenges

The primary challenge with fires employment is the provision of accurate and timely fire support while avoiding undesired lethal effects upon civilians, friendly forces, other partners, or infrastructure. Units may need to avoid an over-reliance on fires in preference to ground maneuver.

Task 24: Support the Protection of Children

Task Description

Children are particularly vulnerable, as they require others to provide for them. Child protection prevents children from becoming victims of violence, exploitation, neglect, and abuse and allows them to grow into healthy and productive adults. The military force, in conjunction

with other actors, addresses child protection both as major aspect of PoC and within many of the other tasks discussed in the *PoC Military Reference Guide*.⁴⁹

Task Relevance to PoC

Comprising up to fifty percent of the population, children are particularly vulnerable to armed conflict because their needs for care are greater, they are dependent upon others to provide that care, and because they have greater vulnerabilities than adults do. They particularly suffer from the impact of dislocation and disruption to their normal lives. Children are exposed to a variety of threats including malnutrition, disease, psychological harm, separation from or loss of their families, physical attack, unexploded ordnance, sexual abuse, child pornography exploitation, abduction, and forcible conscription as slaves, laborers, child-soldiers, or auxiliaries such as lookouts, smugglers, suicide bombers, or messengers. Girls are especially marginalized in some societies, and may even be sold into bondage by their families.

How the Task is Accomplished

a. While the protection of children is a distinct task, it should also be “mainstreamed” within other tasks that relate to situational understanding, achieving desired outcomes, operations, engagement, and environmental shaping. The military force primarily has a supporting role, as other actors are better able to provide for the unique needs of children. While soldiers always have the right of self-defense and it can be hard to distinguish a child from an adult at distance, units may modify their methods and objectives if they know that an adversary’s forces include child-soldiers.

b. Military forces should be alert for the six internationally-recognized grave violations against children:

- Killing or maiming.
- Recruitment or use of children by armed forces.
- Attacks on schools or hospitals.
- Rape or other sexual violence.
- Abduction of children.
- Denial of humanitarian access.

b. It is generally best for children to remain with their immediate or extended families. This is not always possible, however, and children may end up in foster homes, orphanages, in gangs, or wander alone or in small groups. While many orphanages are reputable and do their best to care for the resident children, others have squalid conditions in which children do not receive adequate care and are subjected to exploitation and abuse. Schools should be an early priority to care for and develop children while establishing a normal environment for communities.

c. Child welfare should be consciously incorporated in many of the Chapter 4 tasks that shape a protective environment. In addition to improving the current situation, it will be an important investment that will pay dividends as children become adults (often within the timeframe of a

⁴⁹ See the *Convention on the Rights of the Child and its Operational Protocols*, UNSCR Resolution 1612 (2005), and UNDPKO *Policy on Mainstreaming the Protection, Rights and Well-Being of Children Affected by Armed Conflict within UN Peacekeeping Operations* (2011).

mission). It is particularly important to develop institutional capabilities to deal with children, such as training juvenile specialists in police forces. While military forces will have limited ability to affect these outcomes directly, they can support and enable the creation of effective institutions such as schools, orphanages, juvenile justice systems, recreation opportunities, and medical care. This is primarily done by ensuring a secure environment in which host-state actors, NGOs, and international organizations such as UNICEF can operate. Military forces can also identify and report needs, monitor progress, and emphasize the importance of child protection with host-state counterparts. Civil-military task forces may be established to care for and reintegrate abandoned or abducted children and child-soldiers.

d. Child protection should be considered during operational planning and execution. Leaders should emphasize the importance of child protection, and soldiers should be trained regarding expected standards of behavior and the situations they are likely to encounter. For example, child soldiers that are captured must be separated from other combatants and given the necessary physical and psychological support to be reintegrated into society. Unit plans and operations may account for the likelihood that child soldiers will be encountered, but the practical impact on tactical operations may be limited due to the difficulty in determining whether an armed and deadly adversary is a child or not.

e. Military units may conduct missions that are specifically related to child protection, such as to secure schools or clear unexploded ordnance. Other operations, such as routine patrols, can also support the protection of children by being alert for indicators that child protection is deficient. These indicators may include the prevalent behavior of children, the presence of abandoned children or abducted children who have escaped their captors, and information obtained from interviews. Units should be alert for child abuse in institutions such as orphanages and hospitals; this can be mitigated by interacting with and interviewing patients and orphans while caretakers are not present. In addition to creating the space for child specialists to work, units can respond to identified problems by coordinating for necessary civilian support, if reasonably available. Ultimately, child abuse should be addressed as a criminal matter by a host-state law apparatus that is capable of handling such incidents.

Task Challenges

Children will require particular protection against disease and stronger competitors for food and other essentials. Especially in situations involving large numbers of displaced persons, it will be difficult to find the capacity necessary to adequately care for children who have been separated from their families. Traumatized children, in particular, will require supportive resources that will undoubtedly be lacking. Basic human needs such as food and water may be an urgent priority, and the provision of other requirements, such as schools for children, may be delayed.

Task 25: Support the Elimination of Conflict-Related Sexual Violence

Task Description

Conflict-Related Sexual Violence (CRSV) refers to violent acts of a sexual nature, including rape, sexual slavery, forced prostitution, forced pregnancy, enforced sterilization, mutilation, indecent assault, trafficking, inappropriate medical examinations, strip searches, or any other form of sexual violence of comparable gravity against women, men, girls, or boys. CRSV frequently occurs when undisciplined militaries, police forces, or other armed groups believe they can act with impunity against vulnerable persons. The military force, in conjunction with other actors, must ensure that sexual violence is addressed as a major area of focus and is routinely incorporated into its PoC efforts.

Task Relevance to PoC

a. CRSV frequently occurs during and after armed conflict, and is common within fragile states. It is impossible to obtain a safe and secure environment with adequate PoC if CRSV is a widespread problem. Sexual violence is often a component of genocides and other mass atrocity situations, and may occur as part of a deliberate and systematic campaign to target a victim group (for example, to destroy families and communities or to support ethnic cleansing from an area). It may also occur in a more decentralized fashion due to a general lack of security and stability.

b. Sexual violence should not be dismissed simply as a social problem. Although it may be too easily overlooked by persons in authority, CRSV is a crime against international human rights, humanitarian, criminal, and refugee law. While CRSV is usually directed against women and girls, CRSV also includes assaults against men and boys. The mere threat of CRSV also has an adverse effect on civilian well-being, as potential victims may avoid necessary activities such as travelling, working, farming, obtaining water, or collecting firewood if they are vulnerable when doing so.

How the Task is Accomplished

a. Other nonmilitary actors have a larger role than the military does in mitigating CRSV; these include police forces, advocacy groups, and Women's Protection Advisors that may be assigned to peacekeeping missions. The rule of law is important in criminalizing sexual violence, regardless of the perpetrator.

b. Most (though not all) sexual violence is directed towards women and girls. Despite being prohibited by the 1948 *Universal Declaration of Human Rights* and the 1979 *Convention on the Elimination of All Forms of Discrimination against Women*, women and girls are frequently victims of rape, sexual molestation, culturally-sanctioned oppression, domestic violence, marginalization, barriers to economic and political participation, forced prostitution, indentured status, genital mutilation, forced marriages, and other threats.

c. The 1998 Rome Statute of the International Criminal Court (ICC) recognizes rape as a weapon of war, making rape an individual crime, war crime, and crime against humanity. The Landmark Resolution on Women, Peace and Security, UN Security Council Resolution 1325

(2000), emphasizes the critical role of women in maintaining international peace and security. In addition to expressing the need for increased representation of women in “decision-making levels in national, regional and international institutions and mechanisms for the prevention, management, and resolution of conflict,” the Resolution calls for Member States to respect and enforce their obligations to protect women and girls from sexual violence in armed conflicts, prevent impunity, and prosecute those responsible for sexual and other violent crimes against women and girls.⁵⁰

d. Sexual violence results in long-term physical and psychological harm to the victims themselves and repercussions including disrupted families, unwanted pregnancies, infant mortality and deaths from childbirth, and the spread of sexually-transmitted infections. It can break down the society and social networks for victims, which contributes further to gender inequality and poverty. CRSV victims in traditional societies may experience additional suffering, even if the culture tends to shelter them, because of stigmas that are attached to survivors. Widows may have additional vulnerabilities if they have no means of earning wages, and mothers or other guardians must also see to the needs of children as well as their own. Women often remain silent about CRSV because they fear retribution or being ostracized, or because they are not permitted to have a public voice.

e. The military can support this task in critical ways and must be perceived as a decisively positive force in combating CRSV. In insecure environments in which social services are absent, military units may often be the first responders to CRSV incidents. Soldiers and leaders must be prepared to take appropriate action in such situations. When perpetrated by military personnel, sexual violence undermines the mission’s legitimacy and has adverse effects on military unit cohesion and discipline.

f. The military force should view CRSV elimination as an important and distinct task, but CRSV must also be mainstreamed in most of the other tasks discussed in this reference guide. For example, units must include CRSV as a focus area when attempting to understand a situation. Gender issues should also be incorporated in the pursuit of the desired outcomes. Regardless of their primary intended purpose, patrols and other operations should reduce vulnerabilities and threats related to CRSV. Units should be alert for CRSV indicators such as changes in mobility patterns, anti-women propaganda, and the absence of girls from schools. The military force must address CRSV when engaging security forces, women, (who can be too easily marginalized in some societies), local leaders, and other actors. Finally, environmental shaping (as discussed in Chapter 4) must also account for CRSV issues.

g. Leaders must emphasize the importance of eliminating CRSV, as well as its significance to the mission, and ensure that soldiers receive adequate training. This may include pre-mission and in-mission scenario-based training and the inclusion of CRSV incidents in exercises. Training should be tailored to local and cultural circumstances and address both the standards of conduct expected of soldiers and how to prevent and respond to CRSV incidents that occur (such as initial

⁵⁰ United Nations Security Council, *Resolution 1325 S/Res/1325* (2000), (New York: The United Nations, October 31, 2000), 2-3. Available at http://www.un.org/events/res_1325e.pdf. Also see UNSCRs 1820 (2008), 1888 (2009), and 1960 (2010).

medical treatment for victims, referral to established support systems, conduct of inquiries or investigations, and detention of perpetrators).

h. Leaders should consider the use of female teams to interact with women in the population, and members of these teams may require their own specialized training in cultural awareness and how to handle victims of sexual violence.⁵¹ However, mitigation of sexual violence should not be viewed as a responsibility that falls only on female soldiers. Units will require reliable interpreters, and some of these should be women. Military units may also wish to identify and liaise with local women's organizations that can advise them on the local culture and services available. Units should also coordinate with relevant civilian agencies in the mission, the host state government, and other international organizations.

i. Some operations may be specifically intended to reduce CRSV; for example, security patrols may be scheduled to protect women as they conduct their regular activities such as gathering firewood, obtaining water, travelling to market, or taking children to school. During other operations, such as routine patrols and checkpoints, units should be alert for indicators of CRSV such as the tendency for women to hide, large numbers of displaced women, and statements from witnesses. Interviews with potential victims can help identify incidents and chronic perpetrators, but these should be conducted discretely to prevent retaliation against those who provide information. Units should be prepared to intervene and halt acts of sexual violence when they encounter them and, depending on their guidance, detain perpetrators. As early as possible, these operations should be conducted jointly with host-state security forces, including police. Preventive measures can also reduce the necessity for women to place themselves at risk. For example, stockpiling wood in villages or providing water tanks that are regularly replenished can help keep women secure.⁵²

j. In many cases, CRSV will require responsive actions such as medical treatment for victims, inquiry or investigation, accountability of perpetrators, and remediation. While these measures will largely be beyond the expertise of military forces, they can nonetheless identify requirements, enable other actors with the necessary capabilities, and exert pressure to address these issues. As the victims' social networks will likely be destroyed, it may be necessary to establish one-stop centers that provide medical care, psychological counseling, access to police investigators, legal assistance, and other essential services. Transitional justice efforts (discussed in Chapter 4) must account for survivors of CRSV and ensure they have access to health, education, property rights, justice, and compensation. Host-state justice and medical structures must work to support victims, rather than make their situations worse. A responsive and trained judiciary, perhaps through the use of mobile courts and enhanced with witness protection programs, will help end a culture of impunity. International teams of experts may be necessary to monitor, advise, and report the

⁵¹ "Female Engagement Teams" or similar concepts can be effective techniques, but will require specialized training and guidance to be employed effectively. They should not be misinterpreted to imply that they are the only entities concerned with gender-related issues. These teams are not always appropriate and can create challenges that must be mitigated if they are adopted. Members of such teams are diverted from their normal responsibilities, which can create gaps in their organizations.

⁵² For additional protection practices, see the United Nations, *Addressing Conflict-Related Sexual Violence: An Analytical inventory of Peacekeeping Practice* (New York: UN Development Fund for Women and Department of Peacekeeping Operations, June 2010), 21-37.

deficiencies of host-state institutions that have a role in CRSV mitigation. Collaboration with NGOs and civil society can help the international teams perform these functions.

k. CRSV should be emphasized as a prominent theme in information activities and engagements with key host-state leaders as well as other partners. Commanders should ensure that CRSV receives appropriate emphasis, and host-state authorities should be aware that this is an important standard by which they are judged. Leaders should solicit women's views regarding CRSV and, if they do not already exist, it may be possible to facilitate the creation of women's groups to provide insight on CRSV and other issues. Women's groups, NGOs, the media, and civil society organizations can increase awareness, generate the communal interest to eliminate CRSV, conduct local activities, implement and strengthen local norms in accordance with international standards, share information, form coalitions, and advocate to generate political pressure to eliminate CRSV.⁵³

l. Host-state education programs will be vital to shape attitudes, stress the importance of eliminating CRSV, and counter myths such as victims are to blame or that CRSV is anything but a serious crime. Military leaders should encourage the inclusion of women in community meetings and in sectors such as politics, economics, and security. Perhaps more importantly, they should encourage such gender perspectives within the host state. Positive role models can be highlighted and military leaders should not be perceived as condoning negative behavior either through their statements or by failing to take action when CRSV or sexual exploitation and abuse (SEA) occurs. Notwithstanding local cultural restrictions that may exist, in many traditional societies women (particularly mothers) often exert a decisive influence on the perceptions and actions of males, even if this largely occurs within the home. Women constitute half of the adult population, and their active participation is essential for development and reconciliation.

SEXUAL AND GENDER-BASED VIOLENCE (SGBV)

Gender discrimination and inequality lie at the heart of CRSV. Sexual and gender-based violence (SGBV), a broader term referring to any harmful act based on gender differences, is pervasive, far reaching, and not necessarily conflict-related. Forms of SGBV include discrimination, domestic violence, forced or early marriage, harmful traditional practices such as female genital mutilation (FGM), rape, sexual abuse, forced prostitution, and trafficking. In addition to addressing CRSV, military forces may work closely with humanitarian actors seeking to address SGBV. The UN system will normally operate a sub-cluster or working group to address SGBV within all aspects of the response, such as food and shelter.

SEXUAL EXPLOITATION AND ABUSE

a. SEA prevention refers to the responsibility of humanitarian actors and military forces to respect the physical and sexual integrity of beneficiaries receiving assistance and protection. SEA includes two distinct problems:

⁵³ UN Secretary General Report A/66/677-S/2012/33: *Conflict-Related Sexual Violence* (New York: The United Nations, January 13, 2012), 25.

(1) Sexual Exploitation is defined by the UN as “any actual or attempted abuse of a position of vulnerability, differential power, or trust, for sexual purposes, including, but not limited to, profiting monetarily, socially or politically from the sexual exploitation of another.”

(2) Sexual Abuse is “the actual or threatened physical intrusion of a sexual nature, whether by force or under unequal or coercive conditions.”

b. The UN and NGOs have codes of conduct that further specify what is considered serious misconduct and grounds for disciplinary measures. When aid workers or military forces exploit the local population, they can erode trust in the purpose of the mission and seriously undermine the legitimacy of operations.

c. Leaders must be alert to SEA incidents which may be conducted by persons in authority, including soldiers in the unit or police and civilians associated with the mission. It may also be perpetrated by partners such as host-state security forces, members of organizations or institutions that are intended to assist civilians, and other authorities who believe they will not be held accountable in a surrounding “culture of impunity.” SEA can be committed against civilians, soldiers (especially female soldiers), or civilian employees hired to support the force. Such actions constitute criminal behavior, undermine the legitimacy of the mission, and generate hostility among the population. They can be reduced by training and education, leader emphasis, clearly articulated policies, quick and thorough inquiries or investigations of reported SEA, and disciplinary measures when appropriate. SEA prevention requires command emphasis, and every soldier must have a basic understanding of the issue. It cannot simply be mentioned as one of many topics during pre-deployment training and subsequently ignored. Leaders must ensure that their own actions, policies, and statements do not implicitly condone SEA or related problems such as human trafficking.

Task Challenges

In addition to any operational difficulties associated with stopping perpetrators of CRSV, the military force is likely to encounter three major challenges. First, leaders must ensure that their own soldiers are disciplined and that unit climates preclude CRSV and SEA. Discipline is potentially a challenge with partnered security forces as well. Second, the host state’s culture may include traditions that discriminate against women and in fact condone sexual violence. Cultural norms may also discourage women (or men) from reporting sexual violence, thus complicating the military’s ability to obtain accurate situational understanding. Finally, a culture of impunity may exist in which important partners are in fact egregious sexual predators or enablers.

Task 26: Conduct Combined Operations

Task Description

Combined operations are those in which military units are teamed with other international and host-state actors.⁵⁴ These organizations may include civilian or police agencies that integrate their expertise with military forces. Multidimensional combined operations support the objectives of the participating organizations and can facilitate monitoring, assessments, and the operational effectiveness of the contributing actors. The fact that an operation is conducted jointly may be at least as important as any other mission objective.

Task Relevance to PoC

Combined operations are vital to achieve efficiency, unity of effort, and synergy to establish and maintain a protective environment. Combined operations integrate the wide variety of actors that are essential for PoC and strengthen the population's confidence in the military force and other security organizations, especially participating host-state police. Combined operations expand mutual situational understanding and can improve the effectiveness of the participants and enhance their relationships with each other. They are particularly important to obtain host-state involvement in and ownership of PoC efforts, since the host state retains its obligation to protect civilians and eventually must be capable of doing so. Combined operations also capitalize on the host-state security forces' understanding of the terrain and population. By providing a method to monitor and mentor host-state security forces, combined operations can also support security sector reform.

How the Task is Accomplished

a. Combined operations are facilitated by a common purpose, information sharing, positive relationships, leader emphasis, and teamwork. They could be conducted with all participants contributing as essentially equal members of the operation. Conversely, different organizations may be in supported or supporting roles. For example, a military unit's primary function may be to provide security so that civilian participants in an operation can perform their necessary functions. In other situations, civilian participants may accompany a military unit to make its operations more effective.

b. Routine multidimensional protection teams can be effective to maintain presence, monitor conditions, and conduct assessments that can be agreed upon by all parties. In some situations, such as during the enforcement of peace agreements, it may be appropriate to include rival groups in their composition. Combined operations are also particularly important to support transitions between authorities. For example, if PoC responsibility will shift from an international mission to the host state, combined operations should be conducted before, during, and immediately after the transition. A similar combined approach should be adopted as security responsibilities are transferred from military to police forces. However, combined operations should not be conducted

⁵⁴ The UN and some militaries would refer to such situations as "joint" operations. In other national doctrines, "joint" operations are conducted by elements of different services (i.e., Army, Air Force, Navy, and Marines). In the *PoC Military Reference Guide*, the term "combined" includes integrating other military and nonmilitary organizations as discussed in Task 34—*Coordinate with Other Actors*.

with perpetrators of violence against civilians (particularly any that have been indicted by the International Criminal Court), as this would jeopardize the military force's legitimacy and in many cases would also be illegal under the military force's national laws.

c. While it is possible to integrate individuals at the lowest unit levels (for example, international soldiers and host-state police could operate a vehicle checkpoint), in many situations it is more appropriate to maintain unit integrity and assign particular tasks to specific units. For example, a host-state platoon might be tasked to establish a security cordon for a search operation conducted by an international military unit, or *vice versa*. Language differences and the availability of interpreters will be important determinants of the possible level of integration. Staff integration can be extremely useful, depending upon considerations such as language skills, security access requirements, and operational security precautions.

d. As much as possible, the different participants in combined operations should be involved in planning and preparation, with the lead for these efforts increasingly shifting to host-state organizations. Military leaders should genuinely consult with the other participants, and not just dictate a preconceived concept to them. Additionally, the different participants should be included in any subsequent assessments and follow-up. After-action reviews (AARs) can be particularly important after combined operations to build teamwork and identify improved methods for future operations. As with any other military activity, combined operations will improve with experience. It is important to maintain habitual relationships as much as possible so that improvement can occur.

Task Challenges

Combined operations can be difficult to accomplish effectively because of the potential attitudes and capabilities of the different participants. The various organizations will have dissimilar objectives, priorities, chains of authority, and cultures. They may also tend to be disdainful and mistrustful of outsiders, or otherwise be reluctant to cooperate effectively. Mistakes, misunderstandings, friction, and personality clashes can also undermine combined efforts. Senior leaders who desire effective combined operations may need to emphasize their importance, closely monitor their progress, and take corrective action when necessary. Patience and open-mindedness will be critical to overcome inevitable obstructions. Combined operations will also have to account for logistics. Some participants may need significant support from the military force to contribute effectively, which could cause them to be perceived negatively. Interpreters will be critical in many situations, but will likely be in short supply. Successful combined operations will require significant nurturing, which could divert leader focus from other pressing concerns.

Task 27: Support Relief for Displaced Persons

Task Description

Military forces may have to secure and support the provision of essential services for large numbers of displaced persons (DPs). Humanitarian organizations will usually manage DPs, but in extreme cases they may not be present and military units may have to assume temporary

responsibility. DP camps may be designated and prepared in advance or they may occur in a haphazard manner wherever large numbers of DPs gather. This task largely focuses on DP camps and is closely related to Task 28—*Support Humanitarian Assistance*.

Task Relevance to PoC

Conflict and other disasters often results in large numbers of displaced persons who need security and other essentials such as food, water, shelter, and medical care. When they leave their homes and communities, civilians become more vulnerable to malnutrition, disease, crime, and other afflictions. In addition, they may still be subject to the effects of armed conflict. Large numbers of civilians may seek protection from military units, resulting in spontaneous DP camps (sometimes referred to as “PoC Sites”) adjacent to military bases and outposts. Displaced persons are particularly vulnerable to CRSV as they move between locations and when they are stationary in camps, and military units must be alert to this threat. Civilians may be collected in DP camps to meet these needs efficiently, but DP camps can create new challenges, resulting in more human suffering than they alleviate, particularly when available resources do not meet the demands.

How the Task is Accomplished

a. Many studies of armed conflicts indicate that more civilians are casualties to indirect effects such as disease and malnutrition than they are to direct acts of violence.⁵⁵ Figure 3-12 illustrates the diverse array of conflict-related threats to civilians, and the problems are greatly magnified when civilians are displaced.

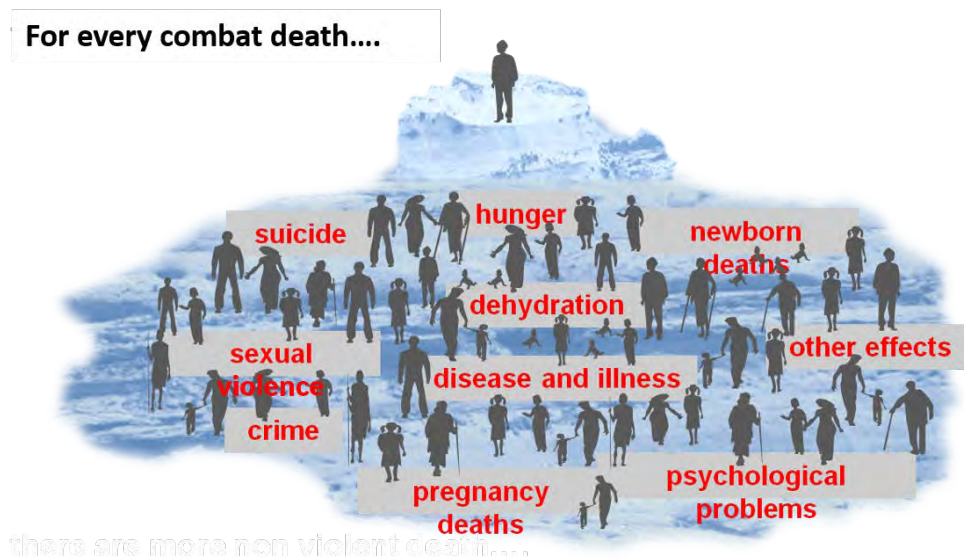

► Figure 3.12: Conflict-Related Civilian Harm ◀

⁵⁵ While relevant studies may differ for a variety of reasons, they generally suggest that the indirect nonviolent conflict-related civilian deaths outnumber violent deaths by three-to-fifteen times. See, for example: Keith Krause, Robert Muggah, and Achim Wennmann, editors, *Global Burden of Armed Violence* (Geneva: Geneva Declaration Secretariat, 2008) and Oliver Degomme and Debarati Guha-Sapir, “Patterns of Mortality Rates in Darfur Conflict,” *The Lancet*, Volume 375, Issue 9711, Pages 294 - 300, 23 January 2010. Also see Ben Coghlan, et al, *Mortality in the Democratic Republic of Congo: Results from a Nationwide Survey* (New York: International Rescue Committee and Burnet Institute, 2004) which controversially claimed a ratio of 62:1.

b. Assistance for DPs is normally managed by civilian organizations such as humanitarian relief agencies from NGOs or international organizations. Military forces will usually be concerned with the security of the areas surrounding DP concentrations, particularly any routes that might be travelled by DPs and relief agencies. Units may also be responsible for local security immediately outside of the camps' perimeters. Military forces preferably avoid being present inside camps to avoid being drawn into disputes and to reduce the likelihood that a DP camp becomes an internment facility.

c. Military forces may also provide logistical or other support to DP camp operations, such as transportation, construction, power, lighting, or communications. They should always try to coordinate closely with organizations that run DP camps to ensure that civilian needs are met as effectively as possible. This coordination can also result in improved understanding of the broader conflict situation, which can help military forces protect civilians better.

d. In some situations it may be appropriate for military forces to collect, transport, and inprocess DPs, then hand them to civilian-run DP camps for longer term care. In other cases, civilian organizations may not be sufficiently established, and military forces will have to set up and temporarily operate DP camps with little or no outside assistance.⁵⁶

e. Camp administrators should attempt to establish order and routine to an inherently chaotic condition. Helpful measures may include administrative inprocessing of the camp occupants, self-governance, adequate security through towers, lighting, and internal and external patrols, effective logistics, and an organized but dignified camp lifestyle. A DP camp is not a prison, and inhabitants should be free to come and go. Selected administration, storage, and medical areas may be secured by wire or other methods to limit access.

f. While it may not be appropriate or possible to control access to the camp, some form of inprocessing can be helpful to gather valuable information, identify civilian needs, confiscate weapons, and facilitate reunification of separated family members. In some situations, an inprocessing sequence may include the following stations:

- **Search and Screen.** Weapons and other contraband are turned in. DPs are identified as members of appropriate major categories (e.g., ethnic group, ex-combatant, child-soldier, orphan, etc).
- **Accountability.** Necessary documentation is completed. DPs are questioned for information that may support broader situational understanding in support of the PoC mission.
- **Identification Card or Band.** Means of identification is issued, or biometric scanning is conducted.

⁵⁶ See the United Nations High Commissioner for Refugees, *Handbook for Emergencies*, Second Edition (New York: UNHCR, 2009) available at <http://www.humanitarianresponse.info/document/manual-unhcr>. Also see The Norwegian Refugee Council "Camp Management Toolkit" at <http://www.nrc.no/?aid=9380323> and "Learn More about Shelter" at http://www.webpal.org/SAFE/aaareconstruction/immediate/refugee_camp.htm.

- **Medical Evaluation.** DPs are medically evaluated and treated.
- **Assignment.** DPs are assigned billeting in one of the sections. Family or community integrity should be maintained when possible. Special attention should be given to the needs of vulnerable persons including unaccompanied children, female-headed households, and the elderly, handicapped, or infirm.
- **Personal Items.** DPs are issued necessary items such as clothing, blankets, or hygiene items.

g. DP self-governance should be incorporated as much as possible to support camp administration. DPs may already have tribal or political leadership structures that can be used, or new leadership may have to be created, particularly if necessary to represent the appropriate gender or ethnic balance. Camps, sections, sub-sections, and billeting facilities should have representatives identified to maintain order, assist in communication of information, and resolve issues. DPs should be recruited as volunteers or as paid workers to support most of the camp functions such as maintenance, trash collection, meal preparation and clean-up, and administration. Some DPs may be able to augment more specialized staff; for example, DPs with medical training can assist in the treatment facility.

h. Adequate internal security is critical to prevent anarchic conditions that jeopardize the well-being of DPs and humanitarian workers in the camp. This may be accomplished by regular patrolling, security towers, lighting, a Quick Reaction Force to respond to serious incidents, and security presence at key locations such as food preparation sites, water points, and medical facilities. The camp should include provisions to handle those who pose a threat to camp security. Such determinations, as well as general internal security requirements, should be the responsibility of local police to the extent that they are capable of implementing a fair rule of law. Host-state personnel may be carefully incorporated into security functions, although they may require training and close supervision to prevent abuse of their responsibilities. Under no circumstances should a DP camp be handed over to host-state authorities if DPs would subsequently be placed at risk. All security personnel must act professionally, refrain from fraternization and corrupt practices, and respect the human rights of the DPs. Security measures should particularly address the possibility of CRSV and threats to children.

i. Camp logistical requirements will be daunting and include food, water, other supplies, facilities, power, human waste disposal, trash, as well as firefighting and other safety matters. Initially, these concerns will likely be the most pressing for military leaders. As civilian organizations become more established, military units should gradually hand over these logistical functions.

j. The camp lifestyle should be orderly, yet DPs should be treated with as much dignity as possible and in a manner that does not violate their human rights. Camp administrators, in conjunction with DP community leaders, should implement and enforce reasonable rules regarding standards of behavior, maintenance and use of facilities, distribution and use of rations and other supplies, trash, pets, and other matters. Once the camp is established and any initial crises are

mitigated, camp administrators can begin to incorporate programs such as recreation, education, work, the tracing of relatives, and resettlement preparations.

Task Challenges

Some of the significant challenges include disease, malnutrition, violence against vulnerable civilians (the elderly, infirm, handicapped, unaccompanied children, and female heads of household), and near-permanent conditions of hopelessness. The numbers of DPs can quickly exceed the capacity of DP camps and the supporting organizations. DP camps may be lucrative targets for perpetrators, since so many potential victims are collected together, and they could create a permanent dependency condition if resettlement prospects decrease over time. In some cases, DP camps could become staging bases for combatants, which could jeopardize the camps' chances of not being targeted by adversaries. DP camps can become semi-permanent if DPs fear that they will lack security or basic needs and services should they leave.

Task 28: Support Humanitarian Assistance

Task Description

Humanitarian assistance is aid and action designed to save lives, alleviate suffering, and maintain and protect human dignity during and in the aftermath of emergencies.⁵⁷ While humanitarian assistance is ideally provided by civilian organizations without military involvement, the military force and other security actors may be mandated or tasked to support conditions conducive to humanitarian action. The military's primary task is to ensure a secure environment in which humanitarian workers can operate. In extreme situations and as a last resort,⁵⁸ humanitarian actors may determine that they require more direct assistance from military forces to deliver assistance safely to people in need.

Task Relevance to PoC

Physical threats to civilians are often accompanied by acute needs for essential goods and services. Civilians may flee a threat, thus losing their access to livelihoods, services, and support networks. Perpetrators may destroy sources of food, water, and shelter or otherwise purposely restrict access to essential services. The situation may be a complex emergency, characterized by both conflict and natural disasters such as droughts or flooding. As discussed in Task 27—*Support Relief for Displaced Persons*, lack of access to clean water, medical services, and other essentials

⁵⁷ Global Humanitarian Assistance, "Defining Humanitarian Aid" (Bristol UK: Global Humanitarian Assistance), available at (<http://www.globalhumanitarianassistance.org/data-guides/defining-humanitarian-aid>).

⁵⁸ "Last resort" implies a temporary situation in which military or civil defense assets augment civilian capabilities to meet a critical humanitarian need. See United Nations, "Foreign Military and Civil Defense Assets in Support of Humanitarian Emergency Operations: What is Last Resort?" (Geneva: Office for the Coordination of Humanitarian Affairs, April 2012), available at <http://ochanet.unocha.org/p/Documents/Last%20Resort%20Pamphlet%20-%20FINAL%20April%202012.pdf>. Also see Guidelines on the Use of Foreign Military and Civil Defence Assets in Disaster Relief (Oslo Guidelines), Revision 1.1 (Geneva: Office for the Coordination of Humanitarian Affairs, November 2007) and other related documents available at <http://www.unocha.org/what-we-do/coordination-tools/UN-CMCoord/publications>.

can harm more civilians than physical violence. Moreover, lack of access to basic goods and services may undermine an individual or communities’ ability to protect or rebound from physical violence. Additionally, competition over scarce essential goods and services can be a root cause of or contribute to conflict and violence against civilians. It is therefore vital to foster an environment conducive to humanitarian assistance to protect civilians. This requirement could accompany other military operations, and may at times be the military’s most important task to prevent widespread human suffering.

How the Task is Accomplished

a. The vast majority of humanitarian organizations have made institutional commitments to adhere to the principles of humanity, neutrality, impartiality, and independence,⁵⁹ which are outlined in Figure 3-13. Humanitarian actors and political/military actors may have different understandings of these principles and their significance. Humanitarian assistance includes the distribution of food, water, shelter, medical care, and other items (such as blankets or cooking materials) to provide for essential needs as well as the necessary coordination, logistics, and communications. The manner in which these principles are implemented by individual humanitarian organizations may vary based on their operational philosophies, procedures, and interpretations of the principles.

<i>Humanity</i>	<i>Neutrality</i>	<i>Impartiality</i>	<i>Operational Independence</i>
Human suffering must be addressed wherever it is found. The purpose of humanitarian action is to protect life and health and ensure respect for human beings.	Humanitarian actors must not take sides in hostilities or engage in controversies of a political, racial, religious or ideological nature.	Humanitarian action must be carried out on the basis of need alone, giving priority to the most urgent cases of distress and making no distinctions on the basis of nationality, race, gender, religious belief, class or political opinions.	Humanitarian action must be autonomous from the political, economic, military or other objectives that any actor may hold with regard to areas where humanitarian action is being implemented.

► **Figure 3-13: Humanitarian Principles**⁶⁰ ◀

b. In addition to providing goods and services (for example, clean water, sanitation, food, and shelter), some humanitarian actors also provide protection programming such as rights education,

⁵⁹ Humanity, impartiality, neutrality, and independence were introduced as ICRC’s guiding principles in 1965. These principles are central to UN humanitarian work as endorsed in General Assembly Resolution 46/182 (1991) and Resolution 58/114 (2004). Following a proliferation of nongovernmental organizations involved in humanitarian action in the late 20th century, these principles were included in a Red Cross/NGO Code of Conduct (1994) that was signed by close to 500 organizations around the world. Also see the United Nations “Human Rights Due Diligence Policy on UN support to non-UN security forces (HRDDP).”

⁶⁰ Figure excerpted from “OCHA on Message,” available at http://ochanet.unocha.org/p/Documents/OOM_HumPrinciple_English.pdf.

local conflict mediation and trust building, and monitoring, reporting and advocacy on the situation. Programming may be limited to ensuring that the provision of essential services does not create or exacerbate harm to civilians. Contributing to conditions that allow for the delivery of humanitarian assistance can support these humanitarian protection activities. It should be noted that in some contexts political and armed actors may not accept humanitarian protection activities as neutral and impartial. Consequently, they may challenge or even target humanitarian workers. These nuances should be taken into consideration when deciding how best to contribute to conditions that enable the provision of humanitarian assistance.

MILITARY ROLE

a. Generally, the military force's primary role is to help provide secure space so that humanitarian actors may operate based on objective and apolitical human needs. In some situations, the military may have more direct involvement; for example, units be asked to provide escorts to humanitarian actors. In such cases, humanitarian use of military assets should seek to comply with international guidance that is designed to safeguard humanitarian actors and the people they seek to assist.⁶¹

b. Where humanitarian actors are not present or able to provide assistance, military forces may be temporarily involved in the actual delivery of essential goods and services until other actors are able to assume the role. While they may become directly involved in humanitarian assistance as a last resort under extreme circumstances, normally military units contribute to an environment conducive to humanitarian action by:

- Establishing and maintaining general security, thus providing space in which humanitarian actors can operate.
- Providing situational awareness regarding such issues as the location, number, and condition of civilians in need.
- Providing information on potential threats.
- Providing communications support.
- Supporting planning efforts.
- Providing security at storage sites, during transload operations, during transportation, and during distribution.
- Improving or building infrastructure capacity for transportation and delivery of humanitarian assistance.
- Providing transportation support (including helicopter transport and airfield operations).
- Providing equipment (such as materiel handling equipment) and operators.
- Supporting and conducting information activities.
- Providing required technical expertise with selected military personnel or units (e.g., medical, construction, water purification, graves registration, interpreters).

⁶¹ For details, see the UN, IASC January 2009 "Civil-Military Guidelines and Reference for Complex Emergencies," for a summary of international guidance on the use of military assets and escorts, at www.humanitarianinfo.org.

- When humanitarian actors are not present or able to provide assistance, initiating humanitarian assistance efforts and transitioning to other actors when they are established.⁶²

HUMANITARIAN SPACE

a. Organizations that deliver humanitarian assistance are diverse, including UN agencies and international and local NGOs, each with a different governing and accountability structure. Adherence to humanitarian principles, established codes of conduct and civil-military guidelines vary. Moreover, many organizations delivering goods and services are now multi-mandated, providing what is intended as shorter-term humanitarian relief (described above) as well as longer-term recovery and development assistance which often contributes to the sustainability of a state.

b. As discussed elsewhere in the *PoC Military Reference Guide*, some humanitarian actors may be very concerned with remaining neutral and independent to gain or retain access to communities in need. “Humanitarian space,” while ill-defined, refers to the ability of humanitarian organizations to operate according to their mandates, charters, and principles. Humanitarian space is not the same as “operational space” for military actors, and includes the five components shown in Figure 3.14:⁶³

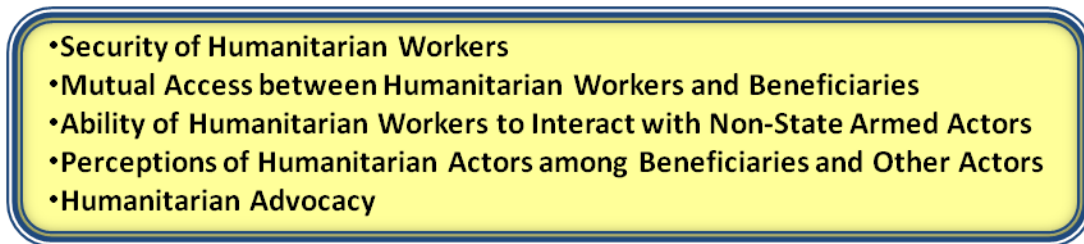

► **Figure 3.14: Humanitarian Space Components** ◀

c. The neutrality and independence of humanitarian workers is especially important in politicized or conflict environments where political or armed actors are unwilling or unable to respect international humanitarian law and are targeting humanitarian workers, the assistance they provide, or the communities they are trying to assist.⁶⁴

d. Humanitarian actors may also be concerned about situations where they can be confused with participants in an armed conflict because military or other security forces are directly providing goods and services to communities or because they are funded by or otherwise associated with armed actors. As such, each humanitarian agency will have different interests and limitations regarding engagement with political and military actors, regardless of whether military

⁶² For information related to humanitarian assistance planning, see the *Sphere Handbook* available at <http://www.sphereproject.org/handbook/>. Also see *UN Civil-Military Coordination Policy* (2012); *Guidelines on the Use of Military and Civil Defense Assets to Support United Nations Humanitarian Activities in Complex Emergencies* (March 2003), and *Use of Military or Armed Escorts for Humanitarian Convoys* (OCHA, 2001).

⁶³ Victoria Metcalfe, Alison Giffen, and Samir Elhawary, *UN Integration and Humanitarian Space* (London: Overseas Development Institute and Washington, DC: The Stimson Center, 2011), 1-3.

⁶⁴ *Ibid.*

actors have been tasked to facilitate humanitarian assistance and/or protect civilians. This diversity can create a confusing environment for military actors who may share common goals with humanitarian actors.

e. Humanitarians have developed guidelines to help clarify best practices for civil-military engagement and established sophisticated coordination mechanisms and offices tasked with engaging political and military actors at the tactical, operational and strategic levels. For example, as discussed in Task 2—*Understand the Actors*, humanitarian organizations often meet in “clusters,” which are coordinating bodies organized by functions such as water and sanitation, protection, emergency shelter, and others. The cluster leads have responsibilities to liaise with external actors. Offices such as the UN Humanitarian Coordinator and the UN Office for the Coordination of Humanitarian Affairs (OCHA), if present, may also liaise with military and political actors.

COORDINATION WITH HUMANITARIAN ACTORS

a. Military support will be more effective when units have a clear understanding of the principles, codes of conduct, and policies that guide and sometimes limit humanitarian action and its interface with military actors. Similarly, understanding humanitarian coordination mechanisms will also help to establish constructive relationships with the humanitarian community.

b. Based on the situational requirements and willingness of humanitarian actors to cooperate, the military force and its civilian partners will have to identify the appropriate space to engage and determine which of the following approaches humanitarians are willing to undertake and will best achieve the desired outcomes.

- Communication between military and humanitarian actors such as sharing information on each other’s purpose, area of operation, activities, and limitations, to help the other identify and prevent, mitigate, or respond to any risks to civilians. This could also include sharing generalized information on the situation.
- Coordination between military and humanitarian actors to reach shared goals and objectives, including the physical protection of civilians.
- Cooperation/collaboration between military and humanitarian actors such as military escorts for humanitarian actors, logistical support to humanitarian aid, or other use of military assets in situations of last resort.

c. Civil-Military Cooperation Centers (CIMICC), or similar offices, at different echelons can be the appropriate agencies to conduct such interaction with humanitarian organizations.

DISTRIBUTION OF HUMANITARIAN ASSISTANCE

In situations where the military becomes involved in the distribution of humanitarian assistance, some common “do’s and don’ts” include the following:⁶⁵

⁶⁵ Developed by Sarah Williamson, Protect the People. Also see additional reference materials on commodity distributions including the World Food Program (WFP) *Emergency Field Operations Pocketbook* (available at

DO

- Do consult with international humanitarian organizations for guidance.
- Do develop a plan of action for the distribution.
- Do adequately staff the distribution site, including translators to assist with communications.
- Do provide water, sanitation, and shelter at the distribution site.
- Do identify leaders from the population to assist with the operation.
- Do attempt to calm the population and create a sense of order prior to handing out supplies.
- Do use members of the community to assist with the distribution by informing people of what is being given to whom, including how and where the distribution will happen.
- Do break up large stockpiles of supplies into smaller parts that can be distributed in different locations or zones at the same time to minimize long lines and crowds.
- Do take into consideration the special needs of women, children, the elderly, infirm, and handicapped who may have a difficult time accessing supplies.
- Do stop the distribution if disorder or violence occurs as a result.

DON'T

- Do not distribute commodities without a site plan.
- Do not send a small team to conduct a distribution.
- Do not create conditions that would lead to dehydration or an unsanitary environment.
- Do not ignore, marginalize, or alienate local leaders in the distribution process.
- Do not use one major distribution point which will attract a large crowd.
- Do not throw commodities from vehicles or other modes of transport, creating a fight for the fittest to obtain the supplies.
- Do not ignore the questions and concerns of the population.
- Do not allow for long lines or waiting periods that will lead to an agitated population and be harmful for vulnerable persons.
- Do not distribute supplies to only one race, gender, religious, or ethnic group which can aggravate social tensions resulting in violence.
- Do not deliver commodities under unsafe conditions that put civilians at risk.
- Do not assume that distribution is an easy task; commodities are valuable items that can be monetized, which is why some people try to cheat the system to get as much as possible.

Task Challenges

a. The military's main challenges include understanding the humanitarian needs of the population; understanding the intentions, capabilities, and requirements of humanitarian actors;

http://www.unicef.org/emerg/files/WFP_manual.pdf); UNHCR's *Commodity Distribution: Practical Guide for Field Staff* (available at <http://www.unhcr.org/3c4d44554.pdf>); and the *Sphere Handbook* (available at <http://www.sphereproject.org/handbook/>).

and consulting with appropriate humanitarian leadership or focal points to determine whether there is an appropriate role for military actors. Available humanitarian resources are likely to be inadequate, which can cause politicization of aid that ideally is humanitarian and apolitical. Additionally, short-term humanitarian assistance objectives can be in conflict with longer-term development priorities.

b. In many cases, the military force may find that humanitarian providers are reluctant to cooperate with military units. This can be mitigated by developing constructive relationships with the relevant actors or by the effective use of intermediaries who have the confidence of military units and humanitarian actors.

c. In situations where military actors are providing assistance directly, they may find that distribution of supplies from ports and airfields to the needy individuals and communities is a daunting task. In addition to obtaining adequate lift and handling assets, supplies must be protected from theft, pest infestation, and spoilage. Additionally, access to needy populations is required. Finally, military logistics and contracting can limit the availability of critical infrastructure to humanitarians, while driving up local prices.

Task 29: Contain Public Unrest

Task Description

Military forces may perform different tasks to mitigate public unrest, including crowd control or the protection of facilities. These tasks are normally performed in support of police forces or host-state military units.

Task Relevance to PoC

Public unrest can threaten other civilians and their property, with increased chances of civilian harm as individuals attempt to protect themselves and their belongings. Public unrest can be manipulated to result in the targeting of vulnerable population groups, especially minorities. In addition, civilians could be at risk from the actions of violent protestors and security forces, especially overreaction with disproportionate means by poorly trained and ill-disciplined units.

How the Task is Accomplished

a. While civil authorities and police (including international Formed Police Units, or FPUs) are normally responsible for controlling such unrest, as a last resort military forces may be required to support them or supplant them if they are incapable. At all times, military leaders should be in close coordination with civilian and police authorities.

b. Public unrest may be caused by legitimate grievances, and a “mob mentality” as well as media sensationalism can cause situations to escalate quickly. Public unrest can also be manipulated by spoilers, and a collaborative intelligence effort may be necessary to identify networks that are attempting to exploit discontent and generate instability.

c. In situations where a population has specific grievances fueling unrest, it would be advisable to deploy civilian advisors along with the unit to identify representatives within the population who can constructively work with authorities to address their concerns.

d. Military units can support police forces by securing a base of operations and other fixed sites, providing logistical support, and conducting shows of force. Military force is only used as a last resort, once a crowd has passed a certain line, and any nonlethal weapons should be tried before lethal force is used. Lethal force may only be used when it is unavoidable to protect life, and should be controlled as far as possible, such as by using designated marksmen or snipers and beginning with warning shots. Observation posts on rooftops or helicopters can help with surveillance, command and control, and delivery of discriminate fires against ringleaders if the Rules of Engagement permit.

Task Challenges

Units must exercise a high degree of disciplined restraint, which can be particularly difficult when they are greatly outnumbered by increasingly violent crowds. There can be a fine line between the exercising of civil rights through legitimate dissent and unlawful public unrest. During conditions of public unrest, transitions between military forces and other actors—such as host-state police forces—will require close coordination and effective information activities.

Chapter 4

Shape a Protective Environment

- **Task 30: Manage Expectations**
- **Task 31: Conduct Information Activities**
- **Task 32: Conduct Engagements with Key Leaders and the Population**
- **Task 33: Support the Political Settlement**
- **Task 34: Coordinate with Other Actors**
- **Task 35: Build Partner Capacity**
- **Task 36: Establish and Maintain a Safe and Secure Environment**
- **Task 37: Support Good Governance**
- **Task 38: Support the Rule of Law**
- **Task 39: Support Social Well-Being**
- **Task 40: Support a Sustainable Economy**
- **Task 41: Maintain PoC during Transitions**
- **Task 42: Support Security Sector Reform**
- **Task 43: Support Disarmament, Demobilization, and Reintegration**
- **Task 44: Support Transitional Justice**
- **Task 45: Support Community Building**

CHAPTER 4 OVERVIEW

a. PoC requires more than the effective performance of military tasks discussed previously in the *PoC Military Reference Guide*. It also depends on the creation of a surrounding environment conducive to PoC. Broadly speaking, this protective environment is achieved through comprehensive engagement and effective stabilization activities. In coordination with other protection actors, military forces can help shape the attitudes, capabilities, and practices necessary for such an environment.

b. **Comprehensive Engagement.** PoC is a multidimensional endeavor that requires contributions from a variety of actors. As discussed in Task 2—*Understand the Actors*, these include military and police forces, NGOs, international organizations, host-state organizations, the media, and businesses, among others. Many have no formal relationship with the military force or its political superiors, but are nevertheless instrumental in achieving the desired outcomes that enhance PoC. Military forces must interact effectively with these other actors to exchange information and coordinate activities to mitigate PoC risks and help achieve desired outcomes. Commanders should ensure their units are able to conduct several tasks effectively to support comprehensive engagement. Military units must be prepared to adopt different postures to various actors over time based upon how they are categorized (e.g., today’s bystander may be tomorrow’s partner or *vice versa*).

c. **Stabilization Activities.** These efforts address what are often the root causes of conflicts that jeopardizes civilians, and are themselves vital for civilian well-being. Outcomes including a safe and secure environment, good governance, the rule of law, social well-being, and a sustainable

economy will help mitigate grievances that result in conflict and ensure lasting PoC. They are largely achieved by the efforts of nonmilitary actors, especially those of the host state, but military forces can perform a critical supporting role.

d. **Transitions.** An operational concept for stabilization may include three stages, as shown in Figure 4.1 and as discussed in Task 41—*Maintain PoC during Transitions*. The military’s stabilization role and major transitions are shown. These transitions can be high-risk periods for civilian well-being.

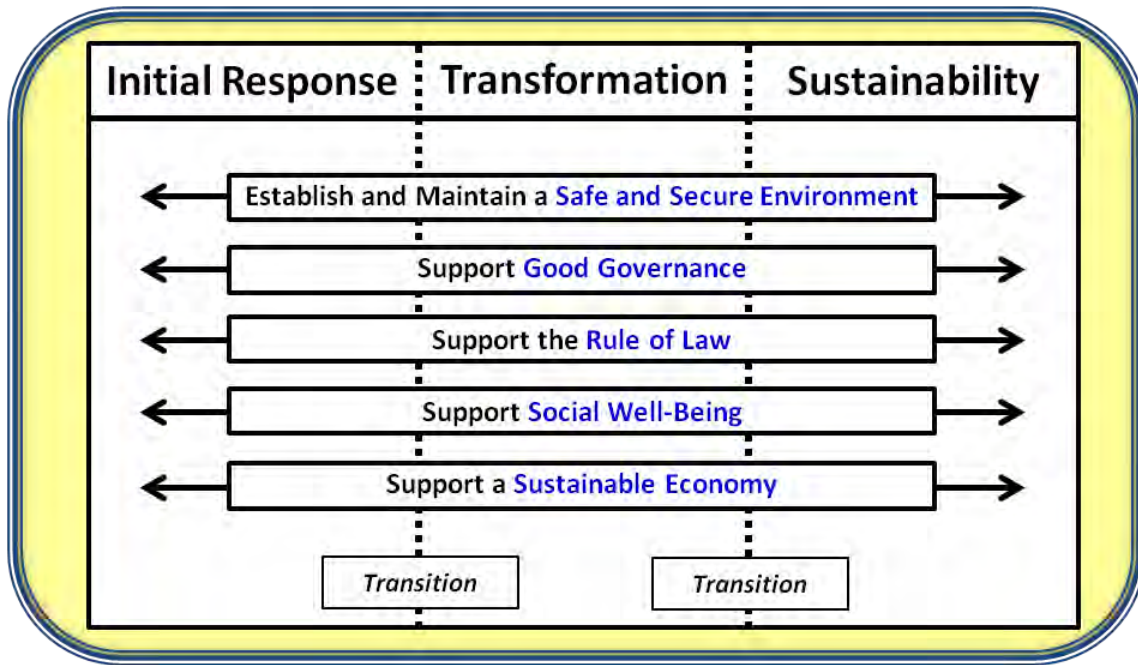

► **Figure 4.1: Desired Outcomes, Stages, and Transitions** ◀

e. This chapter addresses the engagement and stabilization tasks vital for shaping an environment that protects civilians over the long term. Although these tasks are often more within the realm of nonmilitary actors, they are important for PoC and military support can be influential. It is important to integrate these efforts effectively in a broad PoC strategy, as they can sometimes result in tensions with other tasks.

Task 30: Manage Expectations

Task Description

Military units and their partners must refrain from contributing to unrealistic expectations of host-state leaders, the population, and international audiences. This helps maintain credibility and avoid frustration with limited progress and setbacks. Additionally, those in the military force and other stakeholder organizations must have a realistic appreciation of what can and cannot be

accomplished. Expectations may relate to the scope, timeline, actions, and success of the military force and other actors.

Task Relevance to PoC

The military force will be unable to provide the security necessary to protect all civilians all the time, and many will anticipate rapid economic and governance improvement in the host state as well. While it is important for military leaders to gain host-state support for achieving the desired outcomes discussed in this chapter, they must be careful not to exaggerate the collective ability to make quick and significant improvement in a country that is crippled by armed conflict or otherwise fragile. Some observers will expect that a peace operation's impartiality should equate to neutrality or noninvolvement in the surrounding circumstances.⁶⁶ The military force and its partners may have to stress that PoC may require the military to act against certain groups.

How the Task is Accomplished

a. Expectation management relies heavily upon many of the other engagement tasks in this chapter. Military leaders should abide by the adage to “under-promise and over-deliver” while continually enabling modest forward steps in the desired outcomes. Leaders should be cautious about telling audiences what they want to hear, and should not be surprised if, despite efforts to shape realistic expectations, audiences become impatient with the rate of progress. Expectations may need to be revised, but if this occurs too often the legitimacy and credibility of the military force and its partners will become suspect.

b. While units should anticipate setbacks and failures because of corruption, ineptitude, and other factors, they should be cautious about automatically circumventing host-state authorities who must ultimately take ownership of the efforts to achieve the desired outcomes. While all stakeholders should understand that immediate realization of the desired outcomes is not possible, it is nevertheless reasonable and necessary to expect that public officials in the host state and international organizations perform their responsibilities with due diligence. PoC, in particular, is an area that should be viewed as inviolate. Units should be alert for indicators of negligence and malpractice and, if necessary, use their influence with responsible host-state decision-makers to encourage the removal of undeserving officials from their positions.

Task Challenges

Different international and host-state actors will have dissimilar expectations, and reconciling these will pose a challenge for the military force and its partners. Units will also have to be prepared to address inevitable mistakes and failures, to maintain the support of the population and prevent the commitment of different actors from wavering. An enduring challenge will be to ensure that expectations are considered in decisions made as a result of assessments as discussed in Task 8—*Conduct Assessments*.

⁶⁶ A “neutral” actor (such as a broadcast announcer for a sporting event) has no intended impact on the activity. An “impartial” actor (such as a referee) should be non-partisan but may conduct action to enforce rules or mandates and could have significant and potentially controversial impact upon the circumstances.

Task 31: Conduct Information Activities

Task Description

Information activities promulgate messages, inform audiences, and/or influence perceptions regarding the situation and particularly the objectives and actions of the military force.

Task Relevance to PoC

Information activities are increasingly critical in modern military operations, as every statement and action can be instantly monitored by an interconnected world. Information activities can dissuade perpetrators, influence other actors to behave positively, inform vulnerable populations, and increase support for the military force's mission as a legitimate operation to protect civilians. They are also essential to manage expectations and to mitigate the effects of incidents that result in civilian harm.

How the Task is Accomplished

a. Information activities are continuous efforts and should be incorporated into every operation to shape the environment. Effective information activities magnify the impact of other actions, particularly those related to PoC. Similarly, other actions can enhance successful information activities. A command's information activities program both informs outside audiences and enables subordinates to advance important messages effectively during their own engagements.

b. Expanded information activities will be critical to deter and preempt adversaries when indicators suggest that violence against civilians is imminent. The military's information activities should be integrated as much as possible with informational efforts of other partners and should be especially nested within those of the political authorities. Higher military and political echelons may have a robust information staff capability which will be lacking at lower levels. While information activities are important for all units, they should be coordinated at a level with the capacity to manage information programs.

AUDIENCES, MESSAGES, AND METHODS

a. Effective information activities require an understanding of the audiences, messages, and available methods. These three variables will likely result in different approaches, as a single information activity will seldom be effective. Audiences may include the general civilian population in the host state and its subsets (such as women), host-state leaders, victim groups, NGOs, perpetrators (leaders or followers) and other potential adversaries, bystanders, positive or negative actors, the media, international audiences, and domestic leaders and populations in coalition states or troop-contributing countries. Messages are also promulgated to subordinates in the form of guidance for information activities to ensure consistency and facilitate wider dissemination.

b. The content (messages) may be strictly informative or instructional. For example, they could describe recent operations or explain to vulnerable civilians how they might improve their security. Other messages could be intended to influence the opinions and actions of an audience; for

example, they may attempt to convince bystanders to assist the military force and not support perpetrators. Still other messages may be intended to “name and shame” perpetrators, call attention to their actions, and potentially dissuade them from undesired behavior in the future. Messages may be intended to have a long-term significance or they could address immediate issues such as recent events (positive or negative) or disinformation promulgated by adversaries. Examples of enduring messages could include:

- The military force is committed to the protection of civilians.
- The military force is not intended to occupy the host state and will remain only as long as its presence is required for security and stability.
- The mission is supported by the international community as well as responsible host-state actors.
- Perpetrators who deliberately attack civilians (as well as internationally sanctioned peacekeepers) are committing war crimes and will be held accountable.
- It is important to establish a safe and secure environment that does not foster CRSV, threats to children, or other threats to civilians. The host-state and international security forces will not tolerate such acts.

c. Depending upon the intended audience, different informational delivery methods are available to the military force and its partners. Methods should be appropriate to the intended audience; for example, local populations can be reached by signs, leaflets, loudspeakers, newspapers, engagements during patrols, and radio or television broadcasts. In some cultures, radios and televisions may be the primary way to inform groups with whom military forces have limited contact (e.g., women). It may be effective for the mission to create radio or television stations, support their creation by host-state organizations, or otherwise obtain airtime. In many situations websites and social media can reach relevant audiences and if possible should be created in different languages. Audio and video recording and editing equipment can provide extremely valuable capabilities.

GUIDELINES FOR EFFECTIVE INFORMATION ACTIVITIES

a. Information activities will be more effective when military forces follow a few simple guidelines:

(1) First, messages should be timely and truthful, particularly if they are addressing problems, setbacks, or missteps. It may be necessary to strike a balance between timeliness and accuracy. For example, it is desirable to gather all relevant information and analyze it for validity. However, it is also important to address issues quickly to dispel rumors, maintain credibility, and counter misinformation. An established pattern of timely and truthful reporting will enhance the credibility of the mission and will enable the military force to provide initial and interim messaging when situations are changing rapidly and incoming reports are incomplete or contradictory. This is particularly important when adversaries conduct their own informational efforts to discredit the military force or others.

(2) Second, there is also a tradeoff between centrally controlling messages (which can result in consistency and accuracy, but can also result in delay and hampers the ability of subordinate organizations to conduct their own responsive and effective information activities)

and decentralizing authority (which helps with responsive information activities and enhances the credibility of subordinate organizations, but can result in inconsistency and more mistakes). Command guidance for subordinate organizations and soldiers equip them to respond effectively to inquiries and advance desired themes, but will seldom be perfectly crafted for each subordinate's needs. A similar tradeoff applies when synchronizing the military force's information activities with those of a broader political mission.

(3) Third, messages should support realistic expectations within the audiences, in accordance with the rule to "under-promise, but over-deliver." This will help reduce audience frustrations that can develop over time and consequently undermine the military force's credibility. Military forces should not encourage any perception that they can protect all civilians at all times, even when PoC is their highest priority.

(4) Fourth, messages and delivery means should be appropriate for the intended audiences. Translations into foreign languages and dialects should be validated by native speakers who should confirm that messages can be understood correctly and will not be misinterpreted or inadvertently cause offense. Messages should account for education levels of potential audiences, and delivery means should be suitable so that audiences can receive messages easily.

(5) Finally, information activities and other actions must be complementary to maintain the military force's legitimacy and credibility. Information activities must accurately reflect the actions and capabilities of the military force. This applies to the goals and activities of the military force with respect to PoC and any stabilization efforts, and also regarding any threats that may be directed to perpetrators or other spoilers. Effective information activities are not afterthoughts, but require extensive advance planning and coordination, to include with other actors whose efforts can reinforce or undermine informational efforts.

b. Key leader engagement, as discussed in Task 32, is another important way to conduct information activities. Low literacy rates or lack of access to radios and televisions could limit the population's ability to understand messages. Printed media should use host-state language(s), with the content validated by local speakers for accuracy and suitability. Pictorial content is often effective and is particularly necessary for illiterate audiences.

Task Challenges

A major organizational challenge is balancing the desire for responsive, convincing, and decentralized information activities with the desire to have centralized approval and control to provide consistency. Decentralized information activities can result in occasional mistakes and embarrassing statements, while centralized information activities can result in statements that are late, vague, and unconvincing. Another challenge is the need to inform and influence different audiences; a message created for one audience may send an undesired signal to another. Credible information activities will be difficult if the military's partners perpetrate acts of violence against civilians or are corrupt or ineffective; while public exposure of transgressions may create pressure for improvement, it could also undermine relationships with other actors. Information activities will often be dependent upon how events are reported in the media, which includes private commentators on internet blog sites and elsewhere. Many of these sources will value quick sensationalism more than accuracy.

Task 32: Conduct Engagements with Key Leaders and the Population

Task Description

Engagements with key leaders and the population are important ways to coordinate with other actors and to support information activities. Specific engagements can have a variety of purposes such as to foster relationships, clarify intentions, establish desired conditions to support future efforts, convey messages (including promises, threats, condolences, or apologies), or address problems.

Task Relevance to PoC

This task is critical to gain a mutual understanding of civilian risks such as conflict-related sexual violence (CRSV), explain how the military force is pursuing PoC along with its other objectives, and to gain the cooperation that is needed from other actors to support PoC. Engagements with adversaries may at times be appropriate to reduce PoC risks.

How the Task is Accomplished

a. Key leader engagements can be deliberately planned, with arrangements that must be negotiated, or they can occur spontaneously, often in conjunction with other activities (e.g., during a cordon and search operation). The mere conduct of an engagement can be significant, with positive and negative second order effects on the operational environment, other actors, and conflict dynamics. Sometimes even a simple phone call should be viewed as a key leader engagement. Engagements can be particularly instrumental in protecting civilians by dissuading perpetrators, reducing threats and civilian vulnerabilities, and in mitigating the harm for incidents that have occurred. Engagements by military leaders should be integrated with those of the mission's political leadership to speak with a unified voice.

b. Many of the considerations when engaging with key leaders also apply during contact with the local population; any individual can have significant influence. Engagements with the population are important to gain improved situation understanding, promulgate messages, and potentially to bypass uncooperative local leaders. Successful engagements with both key leaders and the general population can result in improved intelligence collection to prevent and halt threats to civilians and magnify the benefit from other positive efforts. They can also help mitigate the negative effects from any mistakes or setbacks. This implies that many soldiers, not just senior leaders, will be conducting such engagements, and any soldier is both an ambassador and an intelligence sensor. All soldiers should be disciplined, professional, respectful of cultural norms, and provided with a way to communicate effectively (such as language training or readily available interpreters). They may also require training on cultural issues, gender issues, interacting with civilians, information collection, and familiarity with the CCIR and other information requirements.

c. Generally, key leader engagements should be conducted in deference to local cultural norms, although there may be prudent reasons to deviate from them. Respect and courtesy, however firmly

a message is delivered, is always an imperative. It is normally appropriate to be particularly respectful to older individuals.

d. Gender norms differ by culture and may necessitate planning and preparation to support effective engagement that includes females in the population. Female interpreters will be critical to facilitate this, and in some situations trained female teams can be valuable ways to interact with the population, understand gender-related issues and other situational matters, provide care to victims, and influence an important but often inaccessible part of the population. Female teams will require special training, as these functions will likely differ from their normal responsibilities. Female teams can experience difficulties as they are integrated into military units, and commander emphasis will be required to overcome any barriers.

e. Arrangements for key leader engagements could include several considerations, including:

(1) **Participants.** Considerations include the number of parties, whether one party is hosting the engagement, the number of representatives in each party, the senior representative of each party, and the levels or ranks of the other participants.

(2) **Venue.** The host will normally determine the venue, which could be an office, a parlor, or an outdoor setting. Considerations for selecting the venue include a variety of factors, such as the age or perceived seniority of the participants (in many cultures, the younger or lower-level party should visit the senior party rather than *vice versa*); the convenience of the participants (it may be easier for a military commander who is circulating through his/her area to visit a local leader than it is for the local leader to travel to and gain access to the military base); or whether the session should be held on neutral ground.

(3) **Security.** These considerations include access to the venue, external security around the perimeter and meeting area, internal security at the actual meeting (e.g., in the meeting room), bodyguards, searches, and weapons retention. Security considerations must be balanced with other factors; as stringent security procedures could dissuade actors from attending, either because they create too much inconvenience, are perceived as insulting, or create an intimidating atmosphere.

(4) **Context.** The context of a key leader engagement includes whether the engagement is a unique occurrence or one of a series that has occurred or is likely to occur. Other contextual issues include any of the situational variables discussed in Chapter 2 that might be particularly relevant to the key leader engagement. To avoid “engagement fratricide” and other problems, military leaders should be as informed as possible regarding related engagements by other actors that have occurred or will occur (for example, if a representative from a civilian agency has met with a local leader).

(5) **Timing.** These considerations include the time of day or night that the engagement occurs, how long the engagement may last (including travel, any meals, and subsequent sessions), and whether or not punctuality is important. Timing may have to account for events that have occurred, cultural holidays or periods of observance, and the sequencing of different engagements with other actors.

(6) **Public or Private Engagement.** Engagements may be multi-party events with many active and passive attendees. Alternatively, they could be private one-on-one sessions with the addition of a trusted interpreter. Both types have their relative merits and drawbacks; for example, public statements and pledges can be extremely helpful, but public engagements can also result in posturing. Frequently both public and private sessions are required to achieve real progress.

(7) **Topics.** Engagements may have a specific agenda, possibly disseminated beforehand, or the discussion topics may be flexible. A planned engagement on one topic can possibly be used as an opportunity to discuss other more critical issues. One purpose could be to dispel rumors and misinformation, of which the military force may not even be aware. In some cases, particularly before a good relationship has been established, it is helpful simply to conduct engagements to build rapport. It is quite possible that different parties will come to engagements with completely different topics in mind. It is important to manage expectations, as some participants may anticipate rapid and complete problem solution, which may be unlikely. Military leaders should be cautious about being manipulated by local leaders who have ulterior motives or who are not completely truthful.

(8) **Outcomes.** Key leader engagements may be viewed as successful if they simply occur, or it may be desired to have a tangible result such as an agreement or pledge. Circumstances will dictate what form of outcome is acceptable, but military leaders should be aware that participants will tend to hear what they want to, while voicing what they think the other party wants to hear. It may be good practice to summarize the results of key leader engagements to ensure that any commitments and expectations are understood.

(9) **Follow-Up.** A pattern of reliable follow-up will greatly enhance the military force's credibility, while a perceived tendency not to follow through will quickly create ill-will and reduce the force's effectiveness. Post-engagement actions will be important to sustain momentum, address concerns, and maintain legitimacy and credibility. Follow up actions may include additional engagements (with participants or others), information activities, responding to requests for information or assistance, or modifications to the operations of military units (e.g., more patrols in an area, or less aggressive patterns of behavior). A general rule of thumb for engagements is to "under-promise, but over-deliver." If it becomes feasible to exceed expectations and address an expressed item of concern, the military force should attempt to do so.

Task Challenges

The military force will have to engage actors who are competitors with each other and be careful about losing its impartiality or being manipulated by an actor for ulterior motivations. Additionally, some of the actors may be perpetrators or otherwise have questionable legitimacy. Some actors will use negotiation as an expedient tactic that is part of a larger campaign in opposition to the military force's objectives. Units should be careful not to overlook or marginalize important groups such as women or minorities so that their concerns can be understood and addressed. If possible, unit engagements should be coordinated with those of other partners to avoid sending contradictory messages. Finally, engagements should be carefully conducted so they do not generate unrealistic expectations.

Task 33: Support the Political Settlement

Task Description

A political settlement, which may include a formal negotiated agreement, refers to the governance, legal, and societal arrangements under which power is shared and wielded. With a just political settlement, disputes are resolved peacefully and human rights protected. Military forces can play a key supporting role in attaining and maintaining an appropriate political settlement.

Task Relevance to PoC

A flawed political settlement may jeopardize civilian well-being, exclude parts of the population, and threatens human rights. It can result in grievances that may defy peaceful resolution. The collapse of a political settlement can result in conflict that puts civilians at risk.

How the Task is Accomplished

a. Achieving and maintaining a political settlement are normally the responsibility of nonmilitary actors, and are key activities for peacemaking and peace building, respectively.

b. Military forces may conduct the following actions to support a political settlement:

(1) **Monitor.** Military forces may also monitor and report on belligerents to help form a clear picture of the latter's capabilities and activities. Once an agreement is concluded, military forces may report on the agreement's implementation.

(2) **Support and Enable.** Military personnel may support peacemaking efforts by providing advice to diplomatic negotiating teams. In some cases, military leaders can provide "good offices" and help rivals reach agreement. Military forces may also provide logistical, intelligence, or security support of peacemaking and peace building efforts. Units may also support SSR and DDR efforts that may be vital to a peace settlement.

(3) **Shows of Force.** The deployment of military forces can provide credibility to diplomatic efforts and deter or intimidate potential perpetrators of violence.

(4) **Contingency Preparation.** Military forces should plan and prepare for potential contingencies that could disrupt the political settlement. Exercises may help this preparation, although in some fragile situations they may be overly provocative.

(5) **Military Operations.** Limited military operations may be conducted to protect vulnerable populations, neutralize perpetrators, or preempt crises through preventative deployments. Peacekeeping operations may be conducted to support the political settlement and build confidence in the process.

Task Challenges

Persistent grievances can derail a political settlement, especially if political leaders are corrupt, incompetent, not committed to inclusivity, or do not pursue progress because they are benefiting from the status quo. Political and armed groups can be extremely fragmented, and leaders who favor a political settlement may be unable to exert sufficient influence over others nominally under their control. A peaceful political settlement may be disrupted by criminal networks, terrorists, hostile nations, extremists who seek greater power, and other spoilers. The military force, and its higher political mission, may see relations with the host state begin to deteriorate over issues such as sovereignty. The military's intelligence and other activities may appear provocative and contribute to host-state resentment and reduced cooperation.

Task 34: Coordinate with Other Actors

Task Description

Military units interact with other stakeholders to share information and, when possible, attain unity of effort to advance PoC and desired outcomes including a safe and secure environment, good governance, the rule of law, social well-being, and a sustainable economy.

Task Relevance to PoC

PoC is a multidimensional challenge with military and nonmilitary aspects. Different actors have important roles in achieving the desired outcomes; however, they may have dissimilar goals, PoC priorities, and authorities. To the extent possible, coordination with these actors is essential to achieve an integrated approach to PoC, avoid gaps and redundancies, and resolve disagreements.

How the Task is Accomplished

a. Military leaders should determine what level of cooperation is possible and desirable with other actors. This determination is largely shaped by political guidance, will naturally change over time, and will be dependent upon how the other actors view the desirability of a cooperative relationship. The overall operational-level determination may differ from that at local levels in certain areas. For example, potential topics for coordination may include information regarding civilian risks and needs, humanitarian space considerations, planned operations, requests for assistance, transitions, and security concerns. Eventually, it will be important for host-state actors to assume control over PoC, maintaining security, and achieving the other desired outcomes. This can be problematic when host-state actors who are to be entrusted with the future may be the same actors who perpetrated actions against civilians in the past.

b. Different levels of interaction include “coexistence,” “communication,” “information sharing,” “formal coordination,” and “collaboration.” As shown in Figure 4.2, higher levels of interaction may be possible when military forces share objectives and a common higher authority with other actors, and a mutual level of trust exists. In some cases, it is only possible or necessary to understand each other's objectives, requirements, capabilities, limitations, procedures, and terminology. However, some closer coordination is particularly critical for the protection of

civilians; an important example is close integration with local police forces. In some cases, the military force will conduct some level of interaction with potential adversaries.

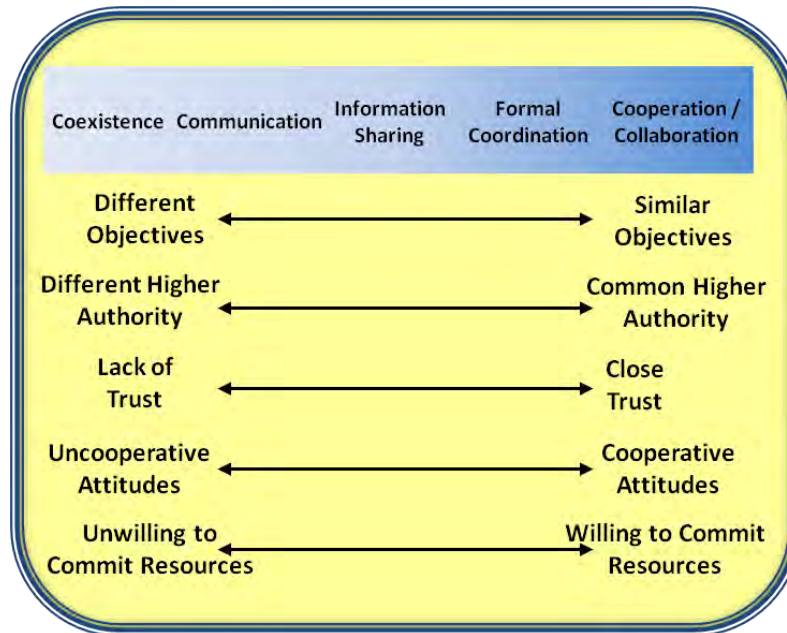

► Figure 4.2: Levels of Integration ◀

c. The different levels of interaction are usually voluntary and may be described as follows:

(1) **Coexistence.** Multiple groups are present in an area but do not interact or communicate with each other. This may be the case with certain groups who do not want any affiliation with the military at all.

(2) **Communication.** Parties have periodic contact such as at meetings that may occur, but do not share substantive information on a regular basis, if at all. Parties may be able to get in touch with each other if necessary (e.g., if they have cell phone numbers for each other). When parties do not share any common interests, direct communication may not even be possible. In cases where no direct communication exists, messages may sometimes be relayed through intermediaries such as civilian personnel associated with the mission or host-state officials.

(3) **Information Sharing.** Parties share substantive information periodically, but such activities are likely to be circumspect and may not occur on a regular basis. Exchanged information is likely to be limited to matters of extremely high mutual concern. For example, an NGO may be willing to provide some information regarding a mass atrocity that has occurred, but will be unwilling to share details about its planned operations.

(4) **Formal Coordination.** Parties regularly exchange information on a wide range of topics, to include some planned operations and generally answering most requests for information when they are reasonably able to do so. The parties may find it beneficial to meet on a routine basis, and may invite representatives to attend their own internal meetings.

(5) **Cooperation/Collaboration.** The highest level of interaction entails cooperation or collaboration which could include jointly conducted planning and operations, collocation of organizations, exchange of liaisons, and other measures to achieve more effective integration. In a loosely collaborative relationship, military forces may occasionally provide direct security for the other actors (e.g., convoy escort). In a tighter collaboration, the interaction will be closer and more routine.

d. Other actors can beneficially contribute to the military force by providing independent assessments of PoC-related issues, to include the military's activities and benchmarking. The military force should invite their input and contribution to after action reviews, either by direct participation or through acceptable intermediaries such as civilian personnel associated with the mission.

COORDINATION GUIDELINES

Some general guidelines will help foster improved coordination with other actors:

- Relationships are important and take time to develop.
- Identify and include stakeholders early. Coordination with host-state security forces (especially police) is particularly important to create a secure environment in which civilians are protected, particularly since police forces will ultimately be responsible for PoC. Military forces should not overlook vulnerable groups that lack power, as these may have long been without a voice.
- Consult, don't dictate.
- Be honest and reliable. Back up words with action.
- Be respectful. Avoid appearing arrogant or condescending. Show proper courtesy to older or higher-ranking counterparts.
- Vertical efforts may be required to supplement horizontal engagements. Direct engagements with counterparts may prove futile for a variety of reasons. It may be necessary to identify a problem to higher echelons in one's chain of command that can in turn encourage their higher counterparts to direct or take necessary actions.
- Consider the impact of and impact on information activities.

CIVIL-MILITARY COOPERATION CENTERS

a. A Civil-Military Cooperation Center (CIMICC) or similar cell⁶⁷ can facilitate information-sharing and coordination between the military force and other actors, including the host-state population and its institutions, such as police forces. Different echelons may establish their own CIMICCs. A CIMICC provides the unit a proponent agency to improve understanding and facilitate remedial action regarding civilian vulnerabilities and threats. It can be an accessible location for civilians to file reports or claims and also serve as a coordination center that can be used by civilian and police organizations whose activities are vital for PoC.

b. A CIMICC's organization and purpose will depend upon the situation and the organizations that are involved. Potential uses for a CIMICC include:

⁶⁷ Other terms that may be used include Humanitarian Operations Center, Humanitarian Assistance Coordination Center, Civil-Military Operations Center (CMOC), or Civil-Military Fusion Center (CFC).

- Managing, storing, and analyzing information related to civil-military issues, especially related to PoC.
- Providing a focal point for nonmilitary agencies or the civilian population to provide information, file claims, submit requests, or conduct civil-military meetings.
- Coordinating operations, such as relief efforts, with military, international, host-state, and other organizations.
- Managing transitions and transfers of responsibility and authority to nonmilitary organizations.
- Implementing measures coordinated by higher civilian and military organizations.
- Managing support requests from civilian organizations and coordinating military responses to these requests.
- Coordinating military requests for support from civilian agencies.
- Managing operations of combined or inter-organizational civilian-military teams.
- Convening civilian-military groups to plan or assess military operations in support of nonmilitary requirements such as security for humanitarian relief convoys or DP camps.

c. Figure 4.3 depicts an example CIMICC organization. The actual staff may come from the military force or it could have a hybrid civilian-military composition. Due to a potential lack of personnel depth in their organizations, many of the civilian members may be present only on a part-time basis. Nonmilitary members could operate within the appropriate functional specialty cell that relates to their organizations.

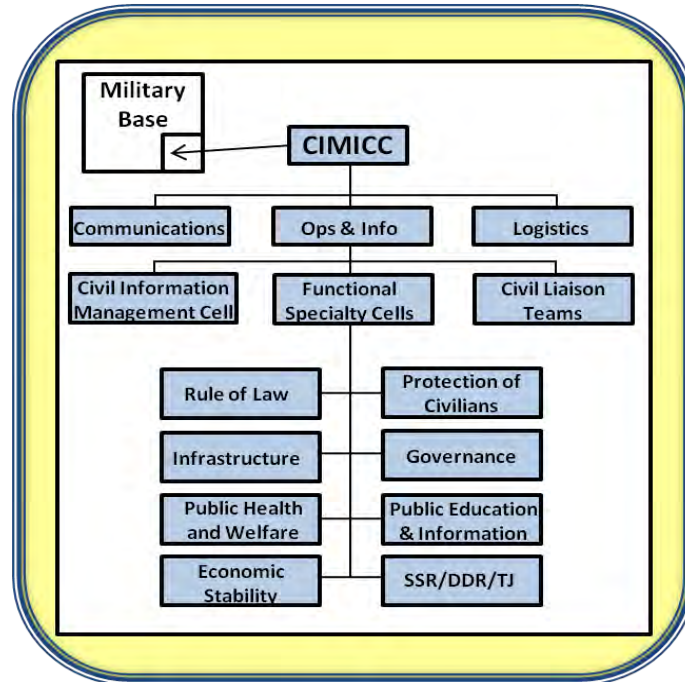

► **Figure 4.3: Example Civil-Military Cooperation Center (CIMICC)** ◀

d. The CIMICC facility itself should include a meeting area, work space, power, and communications (both secure and nonsecure). The location could be on a military base, although

potentially with its own entrance point to facilitate access by civilians. The CIMICC could also be located elsewhere, such as a municipal building. Units should avoid situations in which redundant civil-military coordination offices are created in multiple locations, as these result in overlaps, gaps, and excessive bureaucracy. It also creates a coverage challenge for civilian organizations (especially host-state agencies) that have limited personnel.

e. The CIMICC may include sections to manage communications and logistics. The representative structure in Figure 4.3 includes an Operations and Information Section with a cell to manage information, functional specialty cells, and combined civil liaison teams to conduct field work. In many situations, it may be appropriate to include PoC as a functional specialty cell.

Task Challenges

a. Many critical actors will attempt to preserve their neutrality and avoid the appearance of collaborating with political and military entities such as the military force or the host-state government. A common attitude among NGOs is, “We don’t want the military around until we need to have the military around.” Because of different objectives, cultures, and chains of authority, disagreements and misunderstandings between the actors are likely to occur. Additionally, the competition for scarce resources such as infrastructure and a qualified host state-work force can create tensions between the military force and other actors.

b. A likely challenge for an effective CIMICC is balancing the requirements for access and security. Civilian and military personnel should not be unreasonably inconvenienced if they desire to conduct business at the CIMICC; on the other hand, the CIMICC can be a lucrative and relatively soft target for spoilers. Commanders must be personally interested in and use the CIMICC to increase its significance. An effective CIMICC must be resourced with facilities, staff, supplies, and automation equipment. Some organizations will not have the personnel resources or desire to support the CIMICC in addition to their other responsibilities. This does not necessarily mean that these organizations are irrelevant. Organizational representatives who maintain a frequent presence at the CIMICC should be valuable contributors and not simply be loiterers.

Task 35: Build Partner Capacity

Task Description

Building Partner Capacity (BPC) is a broad term that addresses the potentially most important military task, which is to support and enable partners and other positive actors described in Task 2—*Understand the Actors*, so that these contributors can better achieve the desired outcomes discussed later in this chapter.

Task Relevance to PoC

BPC is an indirect task that requires a different emphasis from many of the other PoC tasks which are directly performed by the military force. Ultimately, the host state must have the capacity to ensure a safe and secure environment in which civilians are protected from different threats, and must likewise develop the capacity to maintain acceptable conditions related to good

governance, the rule of law, social well-being, and a sustainable economy. These efforts will depend upon capable host-state and international actors from the military, police, and civilian sectors. One of the most significant BPC efforts related to PoC is the improvement of host-state policing, and military forces may be able to contribute to this and other BPC activities.

How the Task is Accomplished

a. Partners and other actors whose capacities are of interest to the military force may be grouped as shown in Figure 4.4. Some actors, such as the host-state and military forces which have a PoC mandate or that are parties to a conflict, will have formal legal obligations regarding PoC. Others may be offering their services or can contribute to PoC without an obligation to do so. BPC has short-term, mid-term, and long-term dimensions and realistic objectives should be determined accordingly. Plans for immediate relief needs (such as providing food or creating security units that are comprised of members of an ethnic group) could differ from lasting developmental goals (such as self-sustaining infrastructure or security forces that are ethnically integrated and represent the society’s cross-sections).

	Military Actors	Other Security Actors	Other Actors
International	<ul style="list-style-type: none"> • Military Units • Coalition Partners • Peacekeeping / Peacebuilding Missions 	<ul style="list-style-type: none"> • Police Contingents • Police Trainers • Security Contractors 	<ul style="list-style-type: none"> • Relief Organizations • Development Organizations • International Organizations • NGOs
Host State	<ul style="list-style-type: none"> • Military Units • Ministry of Defense 	<ul style="list-style-type: none"> • Ministries of Interior/Justice • Police • Militias • Private Security Organizations • Intelligence Services 	<ul style="list-style-type: none"> • National, regional, local governments • Communities • Civil Society • Private companies

► Figure 4.4: Categorization of “Partners” ◀

b. Military forces will be mostly concerned with the capacities of military and other security actors, but should not ignore capacities related to non-security sectors. In some cases, military forces can help build the capacity of other international actors who in turn are attempting to improve host-state institutions. In other cases, military forces may directly assist in improving host-state capacity and capability. One of the results of comprehensive engagement with other actors should be an increase in collective capacity to protect civilians.

c. The different actors in Figure 4.4 will have diverse requirements, and military forces may be limited in their authorities and resources regarding the support they can provide. Generally, military forces can help build partner capacity in any of the following ways:

- Provide advisors and mentors. In addition to providing technical assistance on security affairs, advisors should emphasize such issues as respect for human rights, the proper treatment of civilians, and civil-military relations.
- Assist with development of administrative and logistical systems (such as pay, training, maintenance).
- Monitor and if necessary restrain other actors regarding PoC and human rights.
- Assist with assessing, planning, and monitoring efforts to achieve any of the desired outcomes described later in this chapter.
- Provide facilities and bases from which other actors may operate.
- Provide security to other actors.
- Provide transportation, communications, medical, or other logistical support to other actors (either on a routine or emergency basis).
- Provide personnel augmentation to other actors.
- Support and reinforce efforts of other actors through information activities and engagements.

Task Challenges

A major challenge will be synchronizing top-down and bottom-up efforts to improve host-state capabilities. Local bottom-up efforts will often begin earlier and be more critical for immediate impact on PoC, but centralized top-down programs are necessary for long-term sustainability. Subsequent top-down efforts may conflict with or undermine multiple diverse bottom-up efforts that have already begun. Flexibility will be required to integrate existing dissimilar local efforts with newly created centralized programs. “Partnering” is inherently a political choice regarding whom to partner with and build capacity. Potential partners may have questionable legitimacy because of past actions or current behavior. Additionally, the military force will have limited authority, responsibility, and capability to influence other actors. Finally, other mission priorities such as daily operations will limit the military’s ability to focus on building the capacity of other actors.

Task 36: Establish and Maintain a Safe and Secure Environment

Task Description

In conjunction with other security actors, especially police, the military force establishes and maintains a safe and secure environment that generally includes the following conditions:

- Cessation of large-scale violence.
- Public order.
- Legitimate state monopoly over the means of violence.
- Physical security.
- Territorial security.

Task Relevance to PoC

This task mitigates violent threats to civilians and achieves the desired outcome that is most critical for PoC. It is also the desired outcome that is directly linked to military responsibilities and capabilities. A safe and secure environment provides the overarching purpose for many of the other tasks discussed in this reference guide, particularly those in Chapter 3. Additionally, this outcome establishes the necessary conditions for other actors who are more suitable for achieving the other four desired outcomes. Military forces should be aware that combat actions intended to end a conflict and establish security could themselves jeopardize civilian well-being.

How the Task is Accomplished

a. The military force operationalizes this task by conducting many of the other tasks described in the *PoC Military Reference Guide* to reduce violence to a tolerable level. Security responsibilities will normally be shared with international police forces and the host state's military and police forces, among other possible actors. Responsibility and authority for this outcome should progressively shift to the host state, ultimately resulting in a situation that has host-state police forces addressing internal security and its military oriented on external threats. The collective efforts of these actors generally seek to establish five conditions.

b. As was mentioned in the beginning of the chapter and as will be discussed in more detail in Task 41—*Maintain PoC during Transitions*, three stages may comprise an operational concept for stabilization: Initial Response, Transformation, and Sustainability.

c. **Cessation of Large Scale Violence.** This condition removes the most significant threats to civilians, including incidental harm, direct targeting, societal disruption, and impeded access to basic needs. Of particular concern are situations in which genocide, crimes against humanity, war crimes, ethnic cleansing, or mass atrocities may be conducted against civilians.⁶⁸

(1) During the Initial Response stage, tasks may include the neutralization or defeat of some of the parties to a conflict; arrangement, implementation, and monitoring of a ceasefire, peace agreement, or other settlement; separation of the parties to the conflict; and securing populations and key infrastructure. Military forces will be required to deploy to the host state (if they are not already present) and to their respective AOs. They will have to establish bases and logistical networks and achieve the necessary freedom of maneuver, anticipating and responding to threats of large scale violence as they develop. Military forces will also have to establish working relationships with other security actors, including host-state military and police, paramilitary organizations and militias, other foreign military forces, and security contractors. They will have to become rapidly oriented to the nature of PoC risks and maintain understanding as the situation changes.

(2) In the Transformation stage, if mandated, military forces may have to neutralize spoilers; mitigate the potential for violence as old and new grievances surface; support host-state security sector reform (SSR); or support disarmament, demobilization, and reintegration (DDR). These efforts will reduce threats to civilians while building a legitimate host-state security capacity that respects civilian rights.

⁶⁸ See the *MARO Military Planning Handbook* for information on military efforts to prevent and halt mass atrocities.

(3) In the Sustainability stage, these efforts are continued with greater responsibility placed on the host state. External military forces largely perform advisory and monitoring functions.

d. Public Order. In addition to being an essential condition of a safe and secure environment, public order is also vital for the rule of law and will be discussed in greater detail later in this chapter.

(1) During the Initial Response stage, military forces may have to provide temporary local law and order to protect vulnerable civilians from predators who try to take advantage of an absence of authority. This military role may be interpreted as a requirement under international law if the military is employed as an “occupation force.”

(2) During the Transformation stage, security functions are increasingly performed by legitimate host-state organizations, with the preponderance of the effort shifting to domestic police forces, supported by international police if they are present. Additionally, during this stage civic disturbances may become more common, and security forces may be required to conduct measured crowd control.

(3) In the Sustainability stage, host-state police capabilities are improved and integrated into law-making, and the pursuit of stability is properly balanced so that the rights of civilians are not jeopardized by more efficient security forces.

e. Legitimate State Monopoly over the Means of Violence. This condition includes two aspects that are relevant for PoC. The first is that legitimate, capable, and responsible host-state security forces, rather than other armed groups such as criminal gangs or paramilitary organizations controlled by warlords, are the dominant armed actors. This reduces the threat to civilians from organized armed groups. The second is that the host-state security forces act lawfully and are not themselves threats to civilians. This is achieved with professional and capable security forces that respect human rights and are accountable to lawful authority. SSR, DDR, and transitional justice, discussed later in this chapter, are particularly important efforts to achieve this condition.

(1) In the Initial Response stage, military forces will focus on neutralizing armed actors that pose threats to civilians. Additionally, depending upon operational guidance, they may begin to incorporate host-state security forces in such efforts, although these actors may be in a very early stage of development with limited capacity.

(2) In the Transformation stage, host-state security forces will become more capable of independent operations. Military forces may conduct combined operations with these actors, assist with necessary institutional development such as logistical and training systems, and provide technical capabilities (such as intelligence, aviation, or explosive ordnance disposal) that are lacking in the host-state security forces.

(3) In the Sustainability stage, military forces monitor and advise to: (1) improve host-state security capability and ensure that progress is sufficient regarding the professionalism of the host-

state security forces; (2) support an appropriate division of responsibility between host-state military, police, intelligence, and other security actors; and (3) foster appropriate civilian-military relationships with clear civilian control of the security forces. The areas emphasized in the Sustainability stage must begin as early as possible in the previous stages.

f. **Physical Security.** This condition entails the physical protection of civilians, both in any fixed locations (e.g., homes, villages, markets, or DP camps) and when moving from one place to another. It may also include the protection of:

- Infrastructure (e.g., schools, bridges, hospitals, or government facilities).
- Cultural and religious sites.
- Specific individuals and personnel categories (such as government officials, journalists, aid workers, women, children, or political, religious, and ethnic leaders).

Inadequate physical security results in direct and indirect threats to civilians, and an attack against a symbolic or other significant target (such as the destruction of a temple or assassination of a political leader) can spark widespread violence that further threatens civilians. When this condition is adequately achieved, women are safe from sexual violence and children are protected from violence, slavery, and being conscripted as child soldiers. Military forces and other security partners should be aware that women and children could still be victimized by sexual violence when general security conditions are otherwise improved. Forces with a PoC mandate have to be aware of conditions which may not be obvious to the public—who is vulnerable, where, when, and why—and address protection for the most vulnerable people. Military forces and host-state authorities must emphasize the importance of protecting these vulnerable groups, as their physical security is a key indicator as to whether desired outcomes are being achieved.

(1) In the Initial Response stage, military forces should identify potential threats, prioritize their efforts, and identify resources and means that can be used to achieve a reasonable level of physical security. These efforts ideally should be based on an overall PoC mission strategy.⁶⁹ Even during this stage, since PoC is not exclusively a military task, close coordination with other actors is essential to protect civilians from physical harm. Police components are particularly critical, and will become even more significant with time. Forces should anticipate that adversaries will be adaptive, and effective physical security will require good intelligence collection and analysis and proactive operational measures, potentially including actions to neutralize or defeat the adversaries.

(2) A main component of the Transformation stage will be the development of host-state capability to provide physical security. These requirements will expand as host-state institutions grow, adversaries are threatened and attempt to resist, and as grievances potentially arise because expectations are not met.

(3) In the Sustainability phase, host-state security forces under their governmental control have responsibility for physical security. External military forces and other partners monitor the environment, provide advice, and continue to assist with capacity building.

⁶⁹ See Appendix 11 of Annex G for a PoC Strategy template.

g. Territorial Security. Whereas “physical security” addresses the security within an area, “territorial security” focuses on the boundaries that define states, autonomous areas, or other defined territories to protect the areas and especially their inhabitants from external threats. These could include traditional military actions (such as invasions, strikes, or raids) but could also include other threats such as arms flows, an influx of foreign fighters, human trafficking, smuggling, organized crime, and other illicit transnational economic activity. These threats could have a direct or indirect effect on civilian welfare and are mitigated by an effective military, border security, intelligence services, customs services, and immigration control. Armed conflict in other territories can also have other impacts, such as causing displaced persons, which can also create expanded PoC challenges.

(1) Depending on the existing threats, in the Initial Response stage military forces may be required to develop contingency plans, conduct necessary preparations such as obstacle emplacement and exercises, and conduct any necessary operations such as boundary security or combat operations. Any emphasis upon external threats could diminish the military forces’ ability to contribute to a safe and secure internal environment. In this stage, it is vital to achieve a degree of interoperability with other actors, especially with host-state military and border security organizations and to secure civilian populations near borders or other potential conflict zones.

(2) The Transformation stage will emphasize building host-state military capacity to defend against external threats and transferring increased responsibility to the host state. As the host-state military focuses on traditional military roles, internal security responsibilities will increasingly be performed by police forces, enabling them to focus on domestic PoC issues. Additionally, military forces may be required to monitor and support other border security functions such as customs and crossing control. In some situations, cross-border coordination by the military force or other actors may be appropriate to reduce PoC threats.

(3) The Sustainability stage further develops the host-state military capability. Military forces should monitor and report on indicators of corruption and illicit economic activity, which frequently are associated with borders and customs.

Task Challenges

One of the main challenges will be maintaining a safe and secure environment if progress regarding the other desired outcomes is insufficient to reduce grievances. The military and other security forces may have inadequate capability (e.g., forces, resources, or training) to establish effective and widespread area security. The military force may have unclear authority to perform a policing role, while domestic police forces may lack the capability to provide adequate internal security. Host-state security forces may be more focused on regime preservation and stability than they are on PoC and preservation of human rights, and therefore may be a PoC problem rather than a solution. Military units or other security forces may mistakenly or deliberately conduct actions that harm civilians or fuel renewed conflict. This may occur because of misconduct, poor discipline, or overly zealous security and force protection measures.

Task 37: Support Good Governance

Task Description

The military supports other actors that are more capable of and primarily responsible for achieving the following governance-related conditions:

- Provision of essential services.
- Stewardship of state resources.
- Political moderation and accountability.
- Civic participation and empowerment.

Task Relevance to PoC

Transparent, accountable, and effective governance is critical to maintaining a safe and secure environment. Governance also includes the state's responsibility to protect civilians. Civilians are often at risk under conditions of poor governance, such as in authoritarian regimes that violate human rights or in failed and fragile countries with governments that are unwilling or incapable of achieving the desired outcomes adequately.⁷⁰ Poor governance is manifested in corruption, incompetence, and/or oppression and can jeopardize civilian well-being in several ways. It results in inadequate provision of essential services, thereby creating human suffering. Poor governance also results in dissatisfaction and grievances that can result in conflict, which usually impacts civilians. Criminality thrives when governance is inadequate, with civilians frequently the victims. Finally, security forces and paramilitary groups often prey upon the population, often at the behest of bad governments that condone or direct serious human rights abuses. These armed groups can also extort civilians when they are inadequately resourced, which can easily occur because of high-level corruption. Selected population groups, such as minorities or women, are particularly vulnerable in the absence of good governance.

How the Task is Accomplished

a. This task is primarily conducted by nonmilitary actors. Military forces contribute to good governance by establishing and maintaining a safe and secure environment and by fostering appropriate attitudes regarding civilian-military relations among their host-state security counterparts. When directed in extreme cases, such as when other governing authority does not exist, military forces may be temporarily required to perform these functions.

b. Corruption, waste, and inefficiency are apt to be significant problems, requiring that responsible actors pay close attention to the environment of incentives, checks and balances, and punishments. Accountability, an open media, and institutional measures to ensure transparency can help reduce corruption. While they will seldom be responsible for this task, military forces can exert significant influence (for better or worse) and, in any case, should continually assess progress towards the conditions identified above

⁷⁰ A "failed state" refers to a government that is unable to provide the desired outcomes described in this chapter (safe and secure environment, good governance, rule of law, social well-being, and a sustainable economy). A "fragile state" is one whose ability to achieve these outcomes is weak.

c. In the Initial Response stage, the military's role regarding governance will depend upon the mandate, strategic guidance, and direction from its political authorities. It will also depend greatly upon the presence of legitimate and capable government institutions, whether these are from the host state or are established on an interim basis by outside actors. During and immediately after armed conflict, such governance may simply not exist, and military forces (in careful close coordination with their political leadership) may be directed to serve as a short-term substitute. In such cases, military forces should attempt to recruit and integrate suitable host-state representatives, if only on an advisory basis. A likely challenge will be that host-state civil servants with the necessary technical expertise may have been culpable in human rights violations against civilians. Military efforts to establish a safe and secure environment must be closely coordinated with governmental authorities at the national, sectoral, and local levels.

d. In the Transformation stage, governance responsibilities will be firmly vested in civilian authorities from the host state or an interim international executive body. Simultaneously, host-state security forces will increasingly assume responsibility for establishing a safe and secure environment. When possible, external military forces should assist unity of effort between the host-state security forces and governing officials to include fostering appropriate civilian-military relationships. This should be accomplished in close cooperation with any international police that may be in the mission, as they would normally have the lead role for developing national police capabilities. Host-state police forces will be critical links between governance and security. Elections will likely be important events that will require careful planning and monitoring. During this stage, when governance institutions such as constitutions, ministries, and legislatures are being established, their responsibility for PoC and the population's welfare must be the primary consideration.

e. During the Sustainability stage, enduring processes such as routine elections, budgeting, lawmaking, and governmental administration continue. Military forces may within their capabilities monitor these processes and report on them through their channels, but will seldom be directly involved. In their monitoring, they should be aware of potential issues such as civic participation by all societal groups, transparency and accountability, corruption, and an open media that can be an important watchdog regarding good governance.

Task Challenges

Good governance is critical for military efforts to be successful over the long term, but it is difficult to achieve and the military will have limited ability to influence it without effective involvement of other actors. Problematic issues will likely include power sharing; peaceful transfer of political power (e.g., implementing results of fair elections); transition from an authoritarian regime or failed state situation; corruption; the permission of legitimate dissent, free speech, and an open media; gender rights; the implementation of democratic (majority) rule while protecting minority rights; and preserving security and stability without violating human rights.

Task 38: Support the Rule of Law

Task Description

Rule of law consists of diverse elements including policing, courts, corrections, law-making, and human rights. It overlaps significantly and is inseparable from the other desired outcomes. The military force supports other actors that are more capable of and primarily responsible for achieving the following conditions related to the rule of law:

- Just legal frameworks.
- Public order.
- Accountability to the law.
- Access to justice.
- Culture of lawfulness.

Task Relevance to PoC

An effective rule of law is critical to ensure that civilians are protected from human rights violations and crimes including violent acts, authorities behave properly, and perpetrators are deterred and held accountable. A perceived absence of justice can create grievances that lead to violence and vigilante justice. This can occur when rule of law is absent or when a ruling elite exploits a rule of law system for its benefit. Rule of law is particularly vital for mitigating violence and other crimes against women and children and reducing corruption that prevents attainment of all desired outcomes. It is also essential for adjudicating grievances such as disputes over property rights and to ensure legitimate governmental, economic, and security activities.

How the Task is Accomplished

a. Military efforts to establish and maintain a safe and secure environment support the rule of law, and it is unlikely that safety and security are possible when the rule of law is absent. During conflict and other extreme situations when normal justice institutions are absent, military forces may be required to establish an interim rule of law. In most situations, military forces will have little direct responsibility and authority. However, since this outcome is critical to PoC and overall safety and security, military forces should monitor and when possible support progress regarding the rule of law.

b. In the Initial Response stage, depending on their mandate and strategic guidance, military forces may have to establish and maintain law and order temporarily until other authorities are prepared to assume responsibility. As with governance, host-state representatives should be integrated as much as possible, particularly with respect to local policing.

(1) It may be advisable to adapt traditional host-state justice systems as long as they are compatible with accepted human rights standards. The military force may require early assistance from legal experts to assess the host state's rule of law capacity and guide the military's actions.

(2) If a large incarcerated population already exists, it will be important to determine quickly how the prisoners should be categorized and handled (e.g., convicted violent criminals who should remain imprisoned or political prisoners who potentially should be immediately

released). It will be critical to implement an effective vetting process for the disposition of existing prisoners and to determine the military's authority for detaining additional suspects.

c. In the Transformation stage, civilian authorities have primary responsibility for the rule of law. Military forces ensure that a safe and secure environment permits this, and that host-state security forces, particularly police, are capable and perform appropriately. Efforts described in Task 44—*Support Transitional Justice* may be required to address past situations in which civilians were victimized, while new institutions may need to be established to ensure that human rights are adequately protected in the future. Military forces must maintain situational awareness of past and emerging grievances and ensure that host-state security forces support and act in accordance with the rule of law. Land ownership and property rights may be complicated issues that will require expertise and compensation mechanisms to resolve adequately.

d. In the Sustainability stage, it will be important to build and sustain adequate host-state capacity regarding the rule of law. This will require additional specialized capabilities (for example, detectives, forensic analysis, and information management) and capacity (such as ensuring that adequate courts and corrections institutions exist). Responsibilities for rule of law will primarily reside with police and civilian organizations, but military forces within their capabilities should monitor and report on relevant issues, particularly those that affect the well-being of the civilian population.

e. During all stages, information activities will be critical to educate the population regarding the rule of law in accordance with international standards, expected behavior, and justice mechanisms (to include how perpetrators are being handled). Information activities are vital to shape local and international perceptions, address grievances, and overcome any resistance to an effective rule of law. Military information activities should be integrated as much as possible with the informational efforts of other partners. Information activities are discussed further in Task 31—*Conduct Information Activities*.

Task Challenges

a. Effective rule of law is hampered by many challenges. A fundamental issue is whether an adequate body of law exists, or whether a new framework must be created out of previous legal structures, traditional practices, and international standards. Host-state legal processes and institutions may be unfamiliar but still meet international standards for the protection of human rights. There is no requirement that they mirror the legal systems and processes of other countries. Legal institutions may need to be created or professionalized, and will require protection and nurturing, particularly in early stages when security and a culture of lawfulness is not established.

b. Legal processes are normally time-consuming, and actors may attempt to circumvent them to pursue expedient solutions for pressing needs. Property rights and corruption are likely to be major legal issues, particularly if legal officials have personal interests in particular situations. In some societies, gifts to officials, the diversion of funds from their intended purposes, and patronage are all acceptable practices although they all can fuel corruption as viewed by other societies. Other cultural norms, such as the treatment of women and children, may present obstacles as traditional behaviors can persist even when they are illicit by the country's own laws.

c. The military's role in domestic law enforcement matters (that is, its authority and responsibility to take action) may be unclear in many cases, especially if a Status of Forces Agreement (SOFA) does not exist. Units will frequently encounter situations in which they must choose between taking actions for which they have questionable authority, or not acting when the rule of law is being undermined.

Task 39: Support Social Well-Being

Task Description

Social well-being includes a variety of issues from the provision of basic necessities to fostering societal attitudes in which diverse groups are tolerant of each other. The military force supports other actors that are more capable of and primarily responsible for achieving the following conditions related to social well-being:

- Access to and delivery of basic needs services.
- Access to and delivery of education.
- Return and resettlement of refugees and IDPs.
- Social reconstruction.

Task Relevance to PoC

Social well-being includes the provision of basic needs such as food, water, shelter, and medical care as well as the requirements for human dignity such as human rights, education, and a hopeful future. These measures support PoC by addressing a broad range of human security risks. In many situations, these civilian welfare considerations will be more important than the reduction of violence. In other cases, inadequate social well-being can trigger violence and conflict. In addition to their own personal security, individuals will be concerned with the well-being of their families and communities.

How the Task is Accomplished

a. The primary actors for this task are nonmilitary actors including host-state governments at different levels, relief and development agencies from international organizations and NGOs, and local organizations, individuals, and communities. Military efforts to establish and maintain a safe and secure environment contribute to social well-being. However, since this outcome is critical to civilian welfare and overall stability, military forces should monitor and support as possible the achievement of the conditions noted above.

b. While military assets will often provide security for humanitarian relief distributions, forces are occasionally asked to directly manage commodity distribution to people in need. Humanitarian agencies have developed numerous methods and guidance to ensure that commodities are not lost through theft and that distributions are conducted in a safe and effective manner so those who need the supplies most receive them. This and related topics such as humanitarian space are further discussed in Task 28—*Support Humanitarian Assistance*.

c. Particular emphasis is required on the well-being of women and children, who are important in any society but are often vulnerable. Notwithstanding the possible existence of certain cultural gender norms, women should be protected from sexual violence and denials of their human rights. They should also have the opportunity to participate in the political, economic, and security sectors. Children should have the opportunity to be children; they should be provided for, protected from harm, and given a good education. Some UN agencies and NGOs working with children in crisis create child-friendly spaces that provide a safe place for play and recreation.

d. The Initial Response stage may require an emphasis upon essential goods and services, with military forces providing a secure operating environment for humanitarian actors. In some cases, these actors will not yet be established and military forces may be directly involved in providing relief. Vulnerable civilians may seek security or other essentials from military forces, which could require a significant diversion of resources from other tasks. Essential supplies will be valuable commodities that will likely require security to the point of delivery to ensure they are not taken from vulnerable civilians (especially women, children, and the infirm) by stronger spoilers. Orphanages are established and regularly monitored to ensure that conditions are satisfactory and abuses of children (e.g., sexual abuse, harsh discipline, or human trafficking) are not committed.

e. In the Transformation stage the focus shifts from emergency relief to more enduring programs. Other actors, including host-state organizations, should take the lead in these efforts and military forces will orient on maintaining a safe environment for these actors and providing back-up support as appropriate, particularly in the event of emergencies such as natural disasters. Schools will be particularly important to establish a normal lifestyle, take care of children, and invest for the future. Education is also important to foster desirable attitudes such as respect for members of other groups. “Managing diversity” will likely be an important priority for the host state and local communities. As programs for social well-being are established, care must be taken to ensure that the host state is able to assume responsibility and maintain them, and that resources are not wasted through inefficiency or misappropriated by corrupt officials.

f. Military forces primarily support social well-being during the Sustainability stage by ensuring a safe and secure environment is maintained by host-state security forces that are acutely aware of their responsibilities to the civilian population. Military forces should monitor conditions and report through their chains of command while coordinating with other actors as appropriate. Particular attention should be devoted to societal reconciliation, resettlement of displaced civilians, and ensuring that different civilian groups are not disenfranchised.

Task Challenges

Humanitarian and developmental needs are likely to be extensive and urgent, greatly exceeding the availability of resources and competent providers. Short-term efforts may undermine long-term objectives, and long-term projects may provide limited relief for immediate critical needs. Social well-being depends upon the activities of a diverse array of independent actors and identity groups that do not necessarily share common interests and objectives. These efforts are vulnerable to inefficiency, waste, and corruption because of hastily developed networks and imperfect accountability. While humanitarian actors will strive to be apolitical, the allocation of scarce benefits will invariably have political impact. Additionally, the political leadership of the international mission and the host state will have their own responsibilities for social well-being.

Social well-being will be impossible without sufficient progress towards the other desired outcomes.

Task 40: Support a Sustainable Economy

Task Description

The military force supports other actors that are more capable of and primarily responsible for achieving the following economic conditions:

- Macroeconomic stabilization.
- Control over the illicit economy and economic-based threats to peace.
- Market economy sustainability.
- Employment generation.

Task Relevance to PoC

Deprivation results in civilian suffering including malnutrition, exposure, and illness. Without adequate economic growth, problems such as unemployment, inflation, and shortages can result in grievances that foster violence and spur criminal activity, including corruption among government officials. Lack of employment opportunities can hamper DDR efforts and increase the likelihood that ex-combatants resume violence. It can also lead to situations in which poorly-resourced security forces prey upon the population. Illicit economic activities such as human trafficking threaten civilians, and some industries (such as “conflict minerals” and security companies) may contribute to and profit from conflict.

How the Task is Accomplished

a. This task is primarily conducted by nonmilitary actors. Military forces contribute to a sustainable economy primarily through establishing and maintaining a safe and secure environment. However, since this outcome is critical to civilian welfare and overall stability, military forces should also monitor and when possible support the achievement of this desired outcome. Infrastructure improvements in particular can improve civilian well-being and support economic growth.

b. In the Initial Response stage, when economic activity may just be recovering from severe disruption, military forces should be attentive to security requirements at market places, along trade routes, and other locations that are economically significant. Military contracts and purchases may help generate employment, but care must be taken that these do not adversely affect market prices or the labor pool. For example, an educated person may be able to earn more as an interpreter for military forces than s/he would as a teacher or other occupation, which could result in a “brain drain” away from sectors that are more critical for host-state development. Military leaders should also ensure that their soldiers do not contribute to illicit economic activity, such as prostitution which supports human trafficking. Military forces will probably have an important task of protecting economic infrastructure which is vital to the normalization of economic activity. They might also progressively support development actions through the undertaking of quick impact

projects or providing close support to international organizations or host-nation development projects. Military forces should coordinate as much as possible with host-state and international developmental actors.

c. In the Transformation stage, host-state security forces will assume greater responsibility for securing the growing number of legitimate economic enterprises, which helps foster economic growth and increased investment by legitimate domestic and foreign businesses. Entrepreneurial civilians engaged in commercial activities may be victimized by criminal groups and other spoilers, illicit economic activity may grow, and government officials may become involved in corrupt practices. These trends can all combine to increase civilian vulnerabilities and impede economic growth that is essential to the population's welfare. Economic disparities, high unemployment, unmet expectations, and other grievances could result in incidents of violence that further threatens civilians. These challenges could prove daunting for host-state security forces that still have limited capabilities, and external military forces may have to balance the long-term need to shift more responsibility to the host state with short-term requirements for security and PoC.

d. In the Sustainability stage, military forces will have limited impact upon economic conditions. However, they will still need to monitor these conditions, coordinate with other actors, ensure that an adequately safe and secure environment exists, and be aware of economic developments that affect this environment. Military forces may be able to identify, highlight, and work with other partners to address friction points; for example, the distribution of essential resources that cause the population to spend long hours in lines.

Task Challenges

Aside from the likely shortage of resources, the major challenge in developing a sustainable economy will be infusing the funds required to spark quick, widespread, and meaningful growth while maintaining accountability to ensure funds are not wasted or abused. Fostering a legitimate entrepreneurial environment will also be critical.⁷¹ Failure to achieve adequate economic growth will likely result in increased criminal activity and instability that jeopardizes civilian well-being and further undermines the prospects for economic development. Some powerful actors may profit from the current situation and resist efforts intended to achieve improved PoC.

Task 41: Maintain PoC during Transitions

Task Description

Two types of “transitions” are relevant for the military force: the first type relates to the stages of an operation and the second refers to the transfer of responsibilities from one actor to another. As situational conditions progress from the Initial Response stage, through the Transformation Stage, to the Sustainability Stage, the authorities, responsibilities, roles, and activities of different

⁷¹ See Youssef Mahmoud, Anupah Makoond, and Ameya Naik, *Entrepreneurship for Sustaining Peace* (New York, International Peace Institute, June 2017).

actors, including the military force, will change. Transitions may occur between an international coalition and the UN or a regional organization (or *vice-versa*). Ultimately, responsibility and authority must be successfully transitioned to capable host-state authorities to enable a draw-down of the international mission.

Task Relevance to PoC

Transitions can result in high-risk PoC situations. Over time, military actors will assume a diminished role in supporting and enabling civilian organizations. Similarly, international efforts will recede as host-state actors develop the capacity to assume responsibility and authority. If transitions are poorly managed, the desired outcomes will not be realized, which will generate grievances and, potentially, renewed conflict. This can result in conditions that spark violence and create additional civilian suffering.

How the Task is Accomplished

a. In accordance with prescribed objectives and mandates, military forces will usually be concerned with ending an armed conflict and preventing its recurrence. Consequently, a desired outcome will be a safe and secure environment which includes the protection of civilians from threats of violence. In some situations, PoC will in fact be the main purpose of a military operation.

b. Civilian protection from imminent violence usually cannot be sustained over long periods without the attainment of four other critical outcomes that support eventual peace-building and development, including good governance, rule of law, social well-being, and a sustainable economy. All of these outcomes directly relate to civilian vulnerabilities. Additionally, they are critical for effective peace-building and their absence can cause grievances which can be a source of conflict that threatens civilians. However, pursuit of these objectives paradoxically could conflict with PoC if a perception emerges that some groups benefit more than others. Consequently, in most cases these outcomes should be pursued effectively from the outset. In some situations, however, PoC efforts will be limited to those pertaining to achieving a safe and secure environment and not address political, legal, social, or economic outcomes.

c. The military will likely focus on Task 36—*Establish and Maintain a Safe and Secure Environment* to protect civilians and provide the secure space necessary for other actors to operate effectively. In many cases the military can assist these actors with personnel, equipment, communications, information, or supplies. In extreme situations of last resort, units may need to perform nonmilitary tasks until other actors are adequately established and can assume responsibility. This implies a blurred line between limited military operations such as peacekeeping and broader stabilization and development functions that require military and nonmilitary efforts. For example, repair of infrastructure such as bridges and roads can improve military operations and logistics, but also mitigates the isolation of civilian communities and assists government and humanitarian access, the return of displaced persons, and the restoration of services and trade. In all cases, units must maintain situational understanding regarding the status of the outcomes and conditions, as they are all critical to maintaining peace and an effective political settlement.

INITIAL RESPONSE, TRANSFORMATION, AND SUSTAINABILITY STAGES

a. It is helpful to address the desired outcomes in successive stages that may include Initial Response (when military forces may be the only actors with sufficient capacity to influence the situation), Transformation (when nonmilitary actors are adequately established), and Sustainability (when host-state authorities are capable of assuming the lead), as illustrated in Figure 4.1 at the beginning of this chapter.

b. All three stages should account for PoC considerations. Particular attention should be placed on the military's role in managing and supporting the transitions between stages, as PoC risks can increase significantly during these periods. Realistic goals must be established for each stage, and expectations managed accordingly. While it is impossible to create a modern, wealthy democracy overnight, tangible improvements regarding the desired outcomes can still be achieved in most cases. Short-term objectives may be in tension with medium-or-long-term goals, and military forces as well as other actors will have to judiciously prioritize their efforts in accordance with their mandates and the PoC risks that exist.

TRANSITION STEPS

a. Smooth transitions require (1) a manageable situation conducive to the transition, and (2) actors that are capable of accepting their new responsibilities and authorities. As much as possible, transitions should be planned in advance and coordinated with the different stakeholders. It will be necessary to obtain as much concurrence as possible while managing expectations. Transitions should occur based upon actual conditions on the ground rather than planned timelines. Conditions will likely differ in the various areas of a country, and it may be advisable to conduct incremental local and state/provincial transitions based upon the circumstances. It is also possible that transitions regarding one desired outcome (such as good governance) may occur before others.

b. Military forces may approach transitions similarly to reliefs in place or mission handovers. Transitions can be sequential, with an incremental transfer of units, locations, or functions. Conversely, the entire transition can occur simultaneously. In all cases, they should account for PoC considerations, as the civilian risks can increase during and after transitions. Depending upon the circumstances, transitions could include the following general steps.

(1) **Step 1: Preparation.** Outgoing and incoming actors jointly develop a transition plan. Outgoing actors provide information and necessary orientations. Incoming actors conduct necessary training and other organizational preparations. Information activities may be appropriate to support the eventual transition and should emphasize PoC in relevant messages.

(2) **Step 2: Tutorship.** Actors begin conducting combined operations with outgoing actor retaining authority and responsibility, while the incoming actor gradually performs a more prominent role. The main goal of this step is to accustom the incoming actor with the situation, operations, responsibilities, and authorities.

(3) **Step 3: Formal Transition.** The incoming actor assumes responsibility and authority. In some situations, this will be seamless, with conditions essentially identical to those immediately before and after the formal transition. In other cases, the outgoing actor will have no residual presence.

(4) **Step 4: Mentoring.** In some situations, the outgoing actor will remain (often with reduced presence) to provide advice and assistance.

(5) **Step 5: Reachback Support.** After transition has occurred, it may be desirable for the incoming actor to be able to contact the outgoing actor for a variety of purposes, such as to provide any necessary historical information.

c. Figure 2.9, in Chapter 2, depicts a potential framework for planning and managing transitions, including a simple scoring system. Based upon appropriate benchmarks, assessments of the necessary conditions related to the desired outcomes address both the current situation as well as the readiness of relevant actors to sustain progress after the transition. This helps determine whether transition to another stage is warranted and such assessments should account for the perspectives of international and other civilian organizations, as well as those of the relevant host-state actors. In Figure 2.9, which assesses the situation at some point during the Initial Response stage, there are still moderate concerns that are probably not insurmountable, but it would be inadvisable to transition to the Transformation stage at the present time. Even so, the unit is able to look ahead and assess progress regarding some Transformation benchmarks.

d. Important considerations for all scores are the civilian vulnerabilities and threats at the current time and the projected effects on PoC if transitions occur. If a situation is bad enough, it may be necessary to return to an earlier stage. Generally, as transitions are made to more advanced stages, military forces will be less involved in unilateral operations and more involved in advising, mentoring, combined operations, supporting, monitoring, and being prepared for quick response missions.

Task Challenges

One challenge will be to establish and progressively achieve meaningful yet reasonable goals, based upon requirements and available means to address them. Different stakeholders must support the transitions, which will frequently require difficult compromises. Actors must prepare to assume or relinquish responsibility, and transitions can be complicated by the desire to phase out incompetent or malevolent actors. There are apt to be pressures to transition too quickly, and inertia which will result in transitions not occurring quickly enough. Another challenge will be effectively merging top-down and bottom-up efforts that have been occurring.

Task 42: Support Security Sector Reform

Task Description

Security Sector Reform (SSR) is the development of legitimate and accountable security institutions that provide effective internal and external security.⁷²

Task Relevance to PoC

Effective SSR results in capable security forces and systems that support PoC and do not themselves abuse their power and pose threats to civilians. SSR is not simply limited to training and equipping host-state military forces; rather, it is a complex area that includes police, intelligence services, and other public and private security actors. SSR addresses the ends, ways, and means of security activities and is also linked to governance and rule of law considerations such as oversight, legal frameworks, judicial processes, and corrections. Creating the space for effective SSR allows the mission to come to a successful conclusion with PoC institutionalized in the host state.

How the Task is Accomplished

SSR includes three objectives and six functional areas, as discussed below.⁷³

SSR OBJECTIVES

Approaches, programs, and guidelines may differ depending upon whether SSR is conducted by an international organization such as the UN or bilaterally with the host state by other nations. SSR is frequently managed by civilian agencies, with the military playing a critical role. Generally, SSR has three broad objectives, and failure to achieve them results in a security sector that is either unable to protect civilians or that may threaten vulnerable civilians.

- **Accountability**—Increased legitimate governance, oversight, and accountability in the security sector.
- **Effectiveness**—Adequate and sustainable capability and professionalism developed in security actors.
- **Host-state ownership**—Host-state ability and will to assume and sustain responsibility and authority for SSR.

SSR FUNCTIONAL AREAS

a. These objectives are achieved by addressing the following four major functional areas. Each of these functional areas has dual relevance. First, they apply to military forces and other actors

⁷² Some distinguish between SSR, which is focused on police forces and other justice institutions, and “Defense Sector Reform (DSR)” which addresses military forces. In the *PoC Military Reference Guide*, SSR refers to both areas, as well as other security-related elements.

⁷³ See International Security Sector Advisory Team (ISSAT), *SSR In a Nutshell: Manual for Introductory Training on Security Sector Reform* (Geneva: Geneva Centre for the Democratic Control of Armed Forces, 25 November 2010) and Alexander Mayer-Rieckh and Serge Rumin, *Confronting an Abusive Past in Security Sector Reform After Conflict* (Brussels: Initiative for Peacebuilding, 2010)

who are involved in SSR and, second, they apply to the host-state security actors which are in need of reform.

b. Institutional Structure. This functional area includes the organization of SSR providers and security actors at local, state/provincial, and national levels as well as their responsibilities and authorities, and the relationships between the different actors. It also includes administrative and logistical systems such as policy formulation, planning, doctrine, training and education, and sustainment.

c. Resource Management. This functional area includes such activities as budgeting, recruitment, personnel management, promotions, pay, procurement, and facilities. Failure to manage resources effectively can lead to corruption and security forces that are incapable of protecting civilians or who are incentivized to extort or otherwise prey upon vulnerable civilians.

d. Operational Capacity. This functional area addresses both the ability of SSR providers to conduct activities such as advising and mentoring, as well as the ability of host-state security forces to provide security and PoC (especially those tasks identified in Chapter 3). Operational capacity requires sufficient forces that are adequately trained and resourced, conduct successful operations to protect civilians, integrate their activities with those of other partners, and maintain due regard for human rights while treating civilians with dignity and respect.

e. Civilian Oversight and Governance. This functional area includes state-authorized institutions at all levels that manage the activities of security forces. Effective SSR ensures proper civilian-military/police relations and civilian control of security activities. This requires developing the ability of civilian authorities to control security actors as well as conditioning security actors to accept such control. Although military forces may be involved in SSR activities, SSR itself is usually the responsibility of civilian agencies from national governments or international organizations.

SSR CONSIDERATIONS

a. When planning and conducting SSR, several considerations can make such efforts more successful. Those involved with SSR should be culturally aware and avoid conveying arrogance or condescension. It is important to develop host-state leaders and avoid undermining their credibility; however, it may also be necessary to encourage host-state authorities to remove leaders who are corrupt, incompetent, or who do not meet their responsibilities to protect civilians. SSR efforts must build public trust and confidence that security forces are willing and able to protect civilians. This may require extensive effort if security forces in the past have been incapable of doing so or have targeted civilians.

b. SSR efforts should avoid creating host-state dependency or conditions where some host-state leaders impede progress because they are benefiting from the status quo. It is important to integrate host-state personnel into SSR efforts with early “train the trainer” efforts so that host-state individuals perform as much of the actual SSR work as possible.

c. SSR efforts must be adaptive, tenacious, and resilient in the face of inevitable problems. Potential points of failure, such as corruption or security forces that exclude segments of the

population (for example, certain ethnic groups or women), should be anticipated and lessons can be learned when mistakes occur.

d. Although military forces may be primarily oriented on other operational requirements, SSR could be an additional specified or implied task, particularly if an end state includes eventual transition of an operational area to host-state security forces. In some cases, SSR will be the primary focus of selected military units, such as training and advisory teams.

e. Military forces should ensure that SSR incorporates PoC as a prominent theme to enhance the professionalism and capability of host-state security forces. During their SSR efforts, military forces should monitor the activities and attitudes of their host-state counterparts with respect to PoC, respect for human rights, and compliance with international norms and laws. Additionally, PoC should be highlighted throughout the chain of command to assess and influence actions and decisions made by different host-state echelons.

Task Challenges

Effective SSR may require the support and conversion of actors who in the past have been complicit in violent acts against civilians. SSR is a complex, extensive, and resource-intensive effort that may compete with other military mission priorities. “Reform” implies “change,” which may be resisted by stakeholders who are profiting by the status quo. The military force may need to provide increased security while new host-state forces are being developed, which can be problematic if the military force is simultaneously involved in extensive SSR activities.

Task 43: Support Disarmament, Demobilization, and Reintegration

Task Description

Disarmament, Demobilization, and Reintegration (DDR)⁷⁴ entails disarming and disbanding armed groups and reintegrating former belligerents into society. It is often a necessary and highly political process that supports peace and reconciliation and improves public confidence in the peace process. DDR should be integrated with SSR efforts, as restructured security forces may eventually include diverse armed groups. DDR must also be integrated with transitional justice measures discussed in Task 44—*Support Transitional Justice*.⁷⁵

Task Relevance to PoC

Effective DDR requires careful planning and implementation; failure to conduct DDR can result in unaccountable armed groups that fuel conflict and pose a threat to vulnerable civilians. Conversely, premature DDR efforts can leave civilian groups vulnerable if protective capabilities

⁷⁴ A related term is Disarmament, Demobilization, Repatriation, Reintegration, and Resettlement (DDRRR). Generally, DDR refers to combatants from the country in which the conflict is located, while DDRRR refers to combatants from a different country.

⁷⁵ See the *Integrated Disarmament, Demobilization, and Reintegration Standards (IDDRS)*.

are removed. The military force may need to assume a larger area security burden while DDR occurs.

How the Task is Accomplished

a. DDR is often included in peace settlements and ideally contributes to a situation in which legitimate security forces are able to establish a monopoly over the means of violence. Approaches may differ between international organizations such as the UN and national actors that are involved.

b. Disarmament includes the collection, documentation, control and disposal of weapons, ammunition, and explosives. It may be accomplished by confiscation, turn-in, amnesty programs, or incentives such as cash-for-weapons programs. Demobilization involves the controlled discharge of combatants from armed groups and often includes processing individuals in temporary centers. Demobilization includes transitional assistance (or “reinsertion”) to cover basic needs of combatants or their families. This support may include monetary allowances, food, clothes, medical support, short-term education, and shelter. Reintegration is a longer-term process that occurs in communities and, among other things, enables former combatants to obtain employment as civilians. This is critical to give former combatants an alternative to rejoining armed groups.

c. DDR should be conducted under civilian agency lead, with personnel and organizations specifically tasked to manage the process. It requires host-state lead and the support of all relevant national actors to be successful. In addition to conducting most DDR efforts—such as information activities, personnel registration, and weapons collection—civilian agencies manage related functions such as counseling, education, financial support, and medical services, and coordination with host-state actors. Procedures and legalities of any detentions should be resolved in advance. It is important to have DDR control cells at the national, state/provincial, and local levels to monitor progress, address complaints, adjudicate disputes, and track the status of former combatants. During the DDR process, special attention must be given to children and women associated with armed groups.

d. Military forces support DDR primarily by maintaining a secure environment while power balances change. DDR can create instability until trust is established and legitimate security forces are able to maintain peace and order. Military forces may support stability directly with their own operations or with their efforts in support of SSR that help ensure host-state security forces are capable of preventing conflict as other armed groups are disbanded. Enhanced security will likely be required at DDR facilities such as reception centers, weapons storage points, and relocation camps. Particular attention must be paid to protecting vulnerable civilians who are otherwise left unsecured or who may be targeted by spoilers who are frustrated with the DDR process or other matters.⁷⁶

⁷⁶ For additional information on DDR, see United Nations, *Second Generation Disarmament, Demobilization and Reintegration (DDR) Practices in Peace Operations* (New York: United Nations Department of Peacekeeping Operations, 2010), available at http://www.un.org/en/peacekeeping/documents/2GDDR_ENG_WITH_COVER.pdf and the International Forum for the Challenges of Peace Operations, *Considerations for Mission Leadership in United Nations Peacekeeping Operations* (Stockholm: the Challenges Forum, 2010) pages 81-88.

Task Challenges

DDR can be a complex and controversial process that poses many difficult challenges and can result in renewed armed conflict. It can create PoC risks if the process is coercive or if it results in populations that become vulnerable. DDR depends upon trust and commitment by all parties, and may require incremental confidence-building measures that avoid winner-take-all situations. It will be difficult to maintain DDR momentum if administrators are corrupt, incompetent, or overstretched and the program is under-resourced. Other challenges include: resistance to being disarmed; perceptions that some factions are disproportionate beneficiaries; inadequate reintegration opportunities; the appearance that war criminals are being rewarded; inability to ensure security for ex-combatants and their families; loss of control of weapons or replenishment via a flourishing arms trade; and the marginalization of other civilians as former combatants are reintegrated into society. All of these conditions can create resentment and loss of confidence in the DDR process.

Task 44: Support Transitional Justice

Task Description

Transitional Justice refers to judicial and non-judicial measures that address past human rights abuses by truth seeking, criminal prosecution, making amends, memorialization, or institutional reform. Transitional justice is both backward-looking and forward-looking, and seeks to balance accountability, reconciliation, and compensation with the need to achieve peace while preventing future abuses. Transitional justice, SSR, and DDR are interrelated efforts that should be developed to complement each other. For example, effective SSR provides good police, judicial, and prison systems that deliver fair and just outcomes, build respect for the systems, and foster a culture of lawfulness.

Task Relevance to PoC

Transitional justice enables societies to deal with the past and move to a peaceful and just future in which civilians are protected under a suitable rule of law framework. Transitional justice should address the multitude of PoC abuses including mass atrocities, conflict-related sexual violence (CRSV), and human rights violations. However, it should avoid being characterized by revenge and retribution that merely perpetuates a pattern of grievances and conflict.⁷⁷

How the Task is Accomplished

Transitional justice goals include truth, justice, and reconciliation and usually includes five major types of measures:

a. **Truth Seeking.** Truth commissions and other fact-finding measures are important to achieve an accurate and balanced understanding of history. These efforts must be inclusive and as objective

⁷⁷ See International Center for Transitional Justice, “What is Transitional Justice?” (New York: ICTJ, 2009), available at <http://ictj.org/sites/default/files/ICTJ-Global-Transitional-Justice-2009-English.pdf>

as possible, and should be supported by host-state authorities. External participation may also be necessary to lend credibility and impartiality to the effort.

b. Criminal Prosecution. Egregious human rights violators should be tried and punished in accordance with due process. Generally, it is preferable to use host-state court systems, as this facilitates witness participation and fosters host-state ownership. However, in some volatile situations action by the International Criminal Court or an international tribunal in a different country may be preferable.

c. Making Amends. Amends include official material, moral, and symbolic measures that are provided to victims. They may include reparations such as financial compensation, the return of appropriated lands, reconstruction and development programs, and official apologies.

d. Memorialization. These efforts preserve the memory of victims and expand public awareness, in part to dissuade future abuses. Monuments, memorials, museums, holidays, ceremonies, and other measures can facilitate reconciliation and prevent the appearance that past atrocities are being ignored or surviving victims are being bribed into silence. Memorialization can also be achieved with scholarly research, theatre and the arts, and documentaries. State sponsorship of such efforts can demonstrate a commitment to transitional justice.

e. Institutional Reform. SSR and the reform of governance, judicial, and other systems is critical for transitional justice. This includes accountability measures to prevent future abuses and the representation of all groups in public institutions. It may also include “lustration” measures to cleanse a society of hateful ideologies that can foster violence against civilians from particular groups.

Transitional justice must be led by civilian agencies, particularly those of the host state at all levels, and will likely require augmentation by personnel with suitable background. It is a multidimensional effort that is not limited to judicial reform. Previously-marginalized groups must be part of the process; this includes ensuring that women and children are not overlooked. To the extent that they are involved in SSR efforts, military forces perform a critical role in advancing transitional justice. They also indirectly support transitional justice by ensuring a secure environment for transitional justice efforts, monitoring and reporting on conditions, and anticipating obstacles to be mitigated. Unit legal offices may be able to advise and assist host-state transitional justice efforts that involve their military justice systems.

Task Challenges

Transitional justice is a complex process that can be too easily disrupted by a variety of challenges. Problems will be compounded in a host state with weak institutions and fragile political processes. Effective information activities will be necessary to educate and convince local leaders and the population that any new procedures can be appropriately integrated with traditional norms. Prosecution will be difficult when perpetrators are in power at various levels and when a culture of impunity exists. Additionally, the numbers of perpetrators and victims may be so great that transitional justice will be difficult to achieve in practice. Military support to transitional justice will be particularly hampered, as units typically have limited numbers of legal experts, and these

have other primary responsibilities. Finally, the lines between perpetrators and victims may be blurred in situations where past grievances inspired acts of revenge that were themselves atrocities.

Task 45: Support Community Building

Task Description

Community building refers to local efforts to identify, organize, and pursue collective needs and interests to improve overall well-being.

Task Relevance to PoC

As discussed elsewhere in this chapter, PoC depends upon attaining five desired outcomes (a safe and secure environment, good governance, rule of law, social well-being, and a sustainable economy). While it is important that the host state provide “top-down” direction and momentum, it is also critical to have community-based “bottom-up” efforts to realize these outcomes, build trust between different groups, and reduce violence with the community. Local efforts are essential because community members have the presence, interest, and possibly the skills required and credible national institutions may not exist. They are particularly vital to mitigate CRSV as well as threats to children, the elderly and infirm, and other vulnerable groups.

How the Task is Accomplished

a. Community building entails as many people as possible contributing constructively to the five desired outcomes. People must feel safe in doing so and must believe that the outcomes will improve their well-being and that of their families. They must also believe that they are adequately consulted, they are involved in the process, and their opinions matter.

b. It is important to include all societal groups, including those who have been marginalized in the past. Rival groups should be included to defuse friction. Doing so requires agreement in principle that it is in the interest of all to work together, and it is often best to start with relatively easy issues to establish positive momentum.

c. Impartial and respected mediators can help achieve progress, and in many situations women’s groups can be vital to achieve necessary societal support and mitigate the impact of divisive issues. While local leaders are undoubtedly critical to community building, it is usually important to ensure that a small elite does not control all activities and obtain all of the benefits.

d. Military forces can be instrumental in guiding, supporting, and enabling local efforts to strengthen communities within their areas of responsibility. Many of the other tasks discussed in the *PoC Military Reference Guide* can contribute directly to and should be effectively linked with community building, particularly those associated with comprehensive engagement, SSR, DDR, and effective information activities.

e. Police forces are particularly critical in building local communities, and it is important that they are more concerned with PoC than they are with other priorities such as protection of the

state. Local community liaison assistants can be helpful in maintaining coordination with military units by cellular telephone and through periodic meetings. They can support PoC by being part of community alert networks to inform military units of imminent risk.

f. In addition to the primary goal of reducing violence in communities, local measures can address other issues that affect civilian well-being and potentially can create grievances that result in conflict. The acronym SWEAT-MSO can help units focus their efforts (and, more importantly, those of the population and other actors) on issues that are directly relevant to local communities. The SWEAT-MSO categories all contribute to a healthy and thriving community in which PoC is more easily achieved.

- **Sewage.** This category requires organized communal efforts to dispose of waste in ways that do not contaminate water sources or spread diseases.
- **Water.** In addition to production of and access to potable drinking water, other needs include washing, laundry, water for livestock, and irrigation. Uncontrolled actions by “upstream” communities may negatively impact those “downstream.”
- **Electricity.** Local communities may obtain electrical power via generators (which require fuel and maintenance) or by municipal or sectoral power (which could be interrupted or diverted by users closer to the power plant).
- **Academics.** Schools are essential to develop children, provide them a supportive environment, and to establish a normal lifestyle for children and their families. Schools may be vulnerable targets and require special security measures.
- **Trash.** In addition to reducing health risks, communal efforts to collect and dispose of trash contribute to a well-ordered society.
- **Medical.** Communities require clinics that can provide treatment for minor injuries and illness as well as preventive medical care such as vaccinations. Clinics should be able to provide emergency treatment to severe cases and the community should have the ability to evacuate these patients to more advanced treatment facilities.
- **Safety.** In addition to security from crime and acts of violence, local communities should be able to address public safety concerns such as fire prevention and firefighting, unsafe infrastructure, industrial accidents, natural disasters, and other threats unrelated to conflict.
- **Other.** This category may include locally-significant issues such as transportation infrastructure (e.g., a bridge that makes a local village accessible to the outside world), sports and recreation, news and entertainment media, theatre and the arts, or other activities that provide normality, value, or purpose to the population.

Task Challenges

Some of the challenges that impede effective community building include the availability of resources, obtaining consensus on priorities and methods, ensuring equitable sharing of power and benefits, establishing a legitimate leadership that is adequately supported, and ensuring that minorities in the community are not marginalized. In some cases, it may be necessary to establish a sense of community that does not yet adequately exist. Funds, supplies, and other resources that are intended for community building may be diverted by corrupt actors. Spoilers may disrupt communal efforts to preserve the status quo, obtain power, or discredit the military force and any host-state partners.

Chapter 5

Tradeoffs, Challenges, and Risks

- Tradeoffs
- Challenges
- Risks
- Conclusion

Chapter 5 Overview

While conducting operations to achieve PoC, military forces will confront tradeoffs, challenges, and risks that require difficult choices by unit leaders. Although the 3-45 PoC framework provides a comprehensive set of considerations, most problems will be situational in nature and defy a blanket solution. To help weigh relevant factors in decision-making, this part of the *PoC Military Reference Guide* addresses many of the likely issues that may arise.

Tradeoffs

“Tradeoffs” occur when conflicting considerations exist and leaders must attempt to strike a balance between them. Leaders can expect to encounter many of the following tradeoffs to some degree.

a. **Stability and Justice.** Peace and stability will be an important objective, but so too will be a just environment in which human rights are protected and perpetrators are held accountable. PoC includes the provision of human rights and reducing persistent grievances that form the basis for renewed conflict. Efforts to pursue “stability” can quickly trample upon human rights and dismiss the importance of justice. Conversely, the pursuit of justice may motivate perpetrators to continue fighting to avoid being held accountable for any criminal acts or avoid retribution.

b. **Host-State and External Actors.** As discussed throughout the *PoC Military Reference Guide*, host-state ownership and capacity is ultimately decisive to ensure PoC and is also an obligation of any sovereign authority. However, host-state actors may lack the capability or will to protect civilians, in some cases may actively oppose necessary PoC measures, and may themselves be perpetrators who target civilians.

(1) External actors may have limited expertise, capability, or staying power and the different organizations can lack unity of effort. Some actors, including the host-state government or its security forces, may be both a threat to civilians as well as an indispensable part of the solution to achieve PoC. It may be difficult to determine whether these actors are primarily partners or primarily adversaries.

(2) Some host-state cultural norms (such as gender rights and acceptable levels of corruption) may differ from those of international actors that seek to protect civilians effectively while negotiating the cultural landscape. The role of host-state and external actors will require

balancing and continual adjustment to support transitions, and all involved should understand that host-state police forces eventually should be the primary guardians of PoC within the society.

c. Host-State Consent and PoC Efforts. Whether the host-state government has previously been in existence or has been newly formed, its strategic consent is necessary for the overall mission's legitimacy and ability to act. Regardless of the level of host-state strategic consent, the "tactical" consent of local actors may be another matter and eventually have an effect on strategic consent. The military force may have to consider how their PoC efforts could be constrained by or impact host-state consent at different levels.

d. PoC and Other Objectives. PoC is generally a standing consideration that resides with force protection and (in many situations) the neutralization or defeat of an adversary. These three considerations (PoC, force protection, and adversary neutralization/defeat) must be balanced within a unit's mission, which could dictate that any of the three considerations is the top priority. Military units will have many responsibilities besides PoC, and this reality will affect the emphasis and resources that are devoted to PoC. Ideally, the military will be able to focus on establishing and maintaining security, thus enabling other appropriate actors to work towards other important outcomes. It should be noted that nonmilitary actors will also face similar tradeoffs among their own objectives.

e. Short-Term and Long-Term Goals. PoC actors will have to balance immediate measures, such as patrolling to establish a safe and secure environment, with necessary long-term efforts such as SSR or the development of justice and governance institutions. Commanders should invest adequate resources and effort to ensure that long-term goals are not continually subordinated to current crises that could easily consume all available capabilities.

f. PoC Mandate Implementation and Perception of Impartiality. Peacekeeping forces and many of their "partners" usually strive to maintain neutrality between conflicting parties or, at a minimum, impartiality regarding mandate implementation. This facilitates trust and confidence that an acceptable peaceful settlement can be achieved. Particularly when the mandate includes a requirement to protect civilians from imminent threat, the military force may have to act in opposition to the interests of certain organizations, which could diminish its image as a nonpartisan actor.

g. PoC Mandate Interpretation and Needs on the Ground. Another potential issue regarding the implementation of a PoC mandate and other guidance from higher authorities is the extent to which it reflects the operational realities that confront military units. Higher level guidance can be vague, overly ambitious, incomplete, late, or subject to interpretation. Commanders may confront situations that are not addressed by their guidance and may have to consider taking actions that could exceed or conflict with their guidance. In some situations they may be able to obtain clarification, but in others they may have to act in accordance with a loose interpretation of the mandate, a strict interpretation of the mandate, or by the perceived needs on the ground.

h. Security/Secrecy and Transparency. The military force will have to act in concert with other host-state and international actors while being scrutinized by the media, international

organizations, and others. This will require an openness and transparency to foster the confidence and cooperation of other actors and enhance the military's legitimacy. However, units must also be careful safeguard operational security, protect the force, and avoid jeopardizing information sources and methods.

Challenges

a. Challenges and solutions become more complex when PoC is expanded beyond those related to physical violence perpetrated by armed actors during a conflict, but this expansion often critical to ensure that civilians are protected over the long term. Many peace or stability operations may be mandated to build the capacity of a host-state government to contribute to long-term stability. However, such activities do not automatically reduce violence against civilians, and in some cases can spark greater PoC risks. Moreover, cooperation with some host-state actors, such as the governmental leadership or security forces, can create dilemmas if they have a record of abuses.

b. While host-state actors may be important partners for achieving other goals or reducing threats to civilians over time, they may be contributing to abuses in the short term. If the mission challenges the host-state government or other actors' efforts to perpetrate abuses against civilians, it can affect the military force's ability to operate. This is particularly true for peace operations that are deployed under UN Security Council authorization with the strategic consent of the host-state government and parties to the conflict or peace agreement.⁷⁸

c. Although each PoC situation is unique, military leaders can anticipate some common challenges including resource gaps, corruption, constraints, and unity of effort. Additionally, each of the tasks identified in the *PoC Military Reference Guide* includes a discussion of potential challenges associated with that task.

RESOURCE GAPS

a. As illustrated in Figure 5.1, "Gaps" refer to the differences between PoC and other requirements and the capabilities and resources available to address them.

b. PoC requirements are determined by the vulnerabilities and threats, the number of civilians at risk, the geographic area that must be covered, and the extent to which the different desired outcomes (safe and secure environment, good governance, rule of law, social well-being, and a sustainable economy) should be pursued. The military force (and other actors) will also have other requirements that are not specifically related to PoC. These may relate to other mission objectives, logistical needs, force protection concerns, and other internal requirements.

c. Capabilities/capacities of the military force and other actors are determined by such factors as numbers, types of organizations, training, locations, equipment, logistics, leadership, and employment constraints. While the military force may have limited influence over other actors, their capabilities and capacities (or the lack thereof) will be extremely relevant. Gaps essentially result in increased risks as discussed earlier in the *PoC Military Reference Guide*, and gaps between PoC requirements and capabilities/capacities are certain to exist. The military force's

⁷⁸ Giffen, 31.

assessments of requirements and capabilities will probably differ from those of other actors, possibly resulting in a situation where the military believes (given the resources available) it is doing all it can regarding PoC, while others conclude that is not the case.

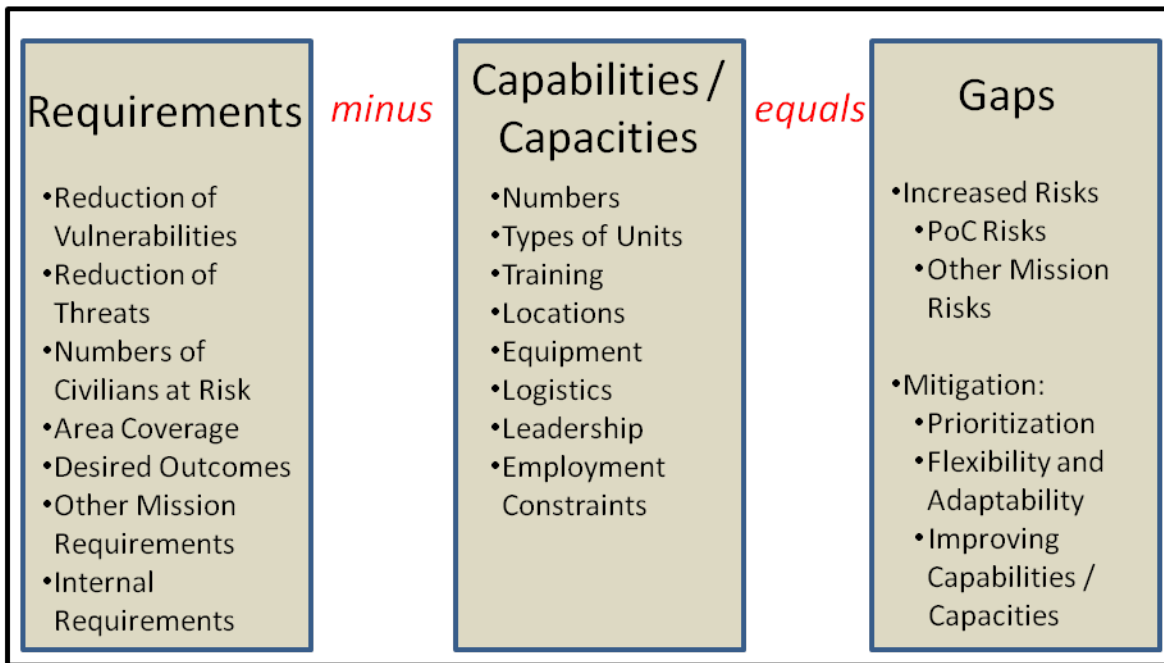

► **Figure 5.1: Resource Gaps** ◀

d. Mitigation approaches include prioritization of objectives, efforts, locations, units to support, vulnerable populations to protect, and actors to influence; economization in non-critical areas; flexibility and adaptability; and measures to improve or increase capabilities and capacities. For example, a “clear-hold-build” approach may be suitable for achieving incremental progress, and demonstrated successes in some areas may help influence other areas at a later date. “Quick wins” may achieve disproportionate effects and generate positive momentum. Units may be used for other than their intended purposes; for example, infantry units may be used in police or civil affairs roles. A concerted effort to build host-state security organizations and conduct Security Sector Reform can provide more capability and capacity to achieve PoC.

CORRUPTION

a. Corruption may be the biggest obstacle to achieving the desired outcomes necessary for PoC. There can be a fine line between corrupt activities (such as bribes, misappropriation, and nepotism) and behavior (such as gifts, reallocation of resources, and patronage) that may have different levels of cultural acceptability, with varying interpretations among local and international actors. Corruption is not just a host-state problem, but can also be found in international organizations including military units, contractors, and others.

b. Corruption results in the diversion of resources from their intended purposes, which can greatly undermine PoC efforts. It also empowers negative actors who jeopardize PoC, threatens responsible actors, and fosters a culture of impunity rather than a culture of lawfulness. The spectrum depicted in Figure 5.2 illustrates two concepts. First, if legitimate officials and

perpetrators of violence are viewed as opposite ends of a spectrum, intermediate categories include criminals and corrupt officials. In practice, there is not always a clear distinction between the categories. For example, an official who generally acts responsibly may occasionally perform a corrupt act if a bribe is large enough (or if the official's family is threatened). Second, perpetrators can obtain indirect leverage over legitimate officials through their personal relationships with criminal actors and corrupt officials, particularly since there are not clear boundaries between the categories.



► Figure 5.2: Corrupt Actors Spectrum ◀

CONSTRAINTS

The military force, or parts of it, may be constrained in its authority and responsibility for PoC-related efforts. Constraints may include limitations on where operations are conducted, the types of operations permitted, ROE, restrictions on activities such as intelligence collection or the ability to conduct investigations, and limited latitude to support some of the nonmilitary efforts commonly associated with stabilization and peace building. These constraints may originate from the mission's political leadership, the mandate, the political leadership and laws of the nations that provide forces, Status of Forces Agreements (SOFAs), and the laws and authorities of the host state. The lack of authority to perform an action may also be interpreted by some as a constraint.

UNITY OF EFFORT

The importance of other actors has been emphasized throughout the *PoC Military Reference Guide*. Military forces can help provide security so that other actors have “space” in which to operate; ultimately, PoC depends upon the effectiveness of police forces and other host-state organizations assisted by international organizations with the necessary nonmilitary expertise. Other actors should have the lead role for many of the tasks described in this document. The assortment of PoC actors will have different interests and objectives, and their willingness to cooperate with the military force will vary. Additionally, they will be responsive to different lines of authority. While some of the tasks in Chapter 4 explain how units can strive for unity of effort, achieving it will be a difficult challenge in the best of circumstances.

Risks

Risk is an important consideration when critical decisions are made. Military planning often identifies anticipated decision points that are likely to arise, and such decisions should account for the risks associated with a potential decision, including those related to PoC. Risk assessment, or anticipating what can go wrong, applies both to long-term missions and specific operations and activities. Risks should be considered in decision making at all levels and mitigated as appropriate, with the understanding that operations will often be conducted while accepting the risks.

MISSION RISKS

In addition to “PoC risks” (comprised of the risk contexts, risk types, vulnerabilities, and threats, as discussed in Chapter 2), military operations related to PoC frequently contain several broader “mission risks.” When PoC risks are integrated, some of the likely major mission risks include the following:

a. **Ineffectiveness.** PoC efforts may be too benign, inadequately resourced, or too late to achieve the desired results. Some actions may be time-consuming and not sufficiently responsive. Lack of progress could generate resentment among host-state individuals who were originally supportive of the military force. In addition to being ineffective, empty threats or other failed efforts can also weaken the credibility of the military force, possibly encouraging—rather than discouraging—future acts of violence against civilians.

b. **Violence Escalation.** Strong PoC actions may ignite a volatile situation or expand an existing conflict. Perpetrators may accelerate their conduct of atrocities because they may perceive that a window of opportunity is closing. Military efforts may inspire host-state opposition groups to increase activities that may have been contributing to the situation. This in turn could prompt a harsh response against civilians or intervention by other external parties. If they believe their survival or power is threatened, adversaries may also attempt to retaliate within and outside of the host state against the military force or others.

c. **Collateral Damage.** Military actions could result in unintended casualties. Although a force may be on a relatively benign mission, a heightened force protection status could result in harm to innocents with unclear status or intentions. The risk of civilian casualties increases when military forces conduct offensive operations, even if they are limited efforts against clearly identified hostile targets. ROE can help mitigate this risk, but even the best ROE cannot address every conceivable situation or prevent confusion regarding their implementation.

d. **Mission Creep.** Because of the multidimensional requirements to achieve desired outcomes (a safe and secure environment, good governance, rule of law, social well-being, and a sustainable economy), PoC efforts could result in an extended commitment and mission expansion to address root causes of conflict, inadequate capacity in a fragile state, and a variety of challenges and second-order effects that could develop. Exit strategies may seek to avoid a premature departure leaving conditions that cause future armed conflict. Some situations may be so intractable that they may not be resolved under the best of circumstances, and certainly not if the military force and its partners are only conducting a limited effort. The military’s role in creating effective space for other actors, who are better able to pursue the desired outcomes, cannot be overstated.

e. **Losses.** Military operations may result in casualties or equipment loss because of hostile contact, accidents, or other causes. In an extreme situation, a unit could be at risk if placed in a situation beyond its capability to handle. Nonmilitary partners from the host state, NGOs, and international organizations could also be placed in jeopardy.

f. **Resistance because of Pride or Nationalism.** Military operations may galvanize opposition in the host state, resulting in the population and government becoming more intransigent or motivating other neutral actors to side against foreign interference. Any increased pressure on any

issues, particularly reforms necessary to advance PoC, may generate resentment in the host state and region. This could result in reduced host-state cooperation with and consent for the mission, with the host-state government potentially becoming an adversary. Some will automatically be suspicious of the motives behind the military operation, and the wide range of military activities may distract attention from PoC issues or provide an excuse for host-state and international actors not to conduct efforts that are necessary to advance PoC.

g. Partner Friction. The military force may disagree with other host-state and international actors regarding goals, methods, burden-sharing, mandate interpretation, or other issues. Some actors may contend that efforts should be limited to humanitarian assistance or peacekeeping duties that consist of monitoring events in a relatively secure environment. Others may be influenced by their constituencies who are skeptical about the effort, particularly if there are setbacks.

h. Negative Second-Order Effects. Even if largely successful, robust PoC efforts may result in host-state dependence upon external actors. Ineffective or costly efforts could cause reluctance to take necessary action to protect civilians. Failures could also encourage future perpetrators and prompt more acts of violence, if it appears that the military force is less likely to take action in the future. If perpetrators perceive that PoC actions are really political efforts that lack impartiality, the result could include restrictions on humanitarian relief to victims and/or endangered populations, as well as the targeting of aid providers. This would lead to potential reduction in humanitarian access. Concerns about such risks could dissuade NGOs from cooperating with the military force. PoC actions could also inflame tensions in the country or region.

i. Risks of Inaction. Additionally, commanders should be aware of the potential risks of not taking action. These include the possibility that perpetrators may be emboldened and the situation could deteriorate even further, requiring a more robust effort in the future.

RISK MITIGATION

a. Risk mitigation is a deliberate effort to assess what can go wrong and identify ways to reduce the likelihood and consequences of PoC risks discussed in Chapter 2 and other mission risks discussed above. Risk mitigation occurs formally or informally at all levels and can encompass situations, needs, plans and operations, and specific decisions that are made. Any action entails some level of risk; conversely, there are usually other risks if the action is not taken.

b. Typical risk mitigation approaches involve the following steps:

- Step 1: Identify risks.
- Step 2: Assess probability and severity of risks.
- Step 3: Identify mitigation measures.
- Step 4: Implement controls.

c. Mitigation refers to efforts that prevent potential risks from occurring, reduce their impact should they occur, and respond appropriately if necessary. Mitigation measures may include:

- Training.
- Adjusted force levels, deployment, or composition.
- Contingency planning.
- Designated response forces or reserves.

- Key leader engagement.
- Information activities.
- Elevated or delegated decision authority.
- Modified rules of engagement.
- Reduced or expanded information sharing with other actors.

d. Risk mitigation can be more effective when done in collaboration with other actors such as host-state representatives or NGOs and civilian agencies. This helps provide a comprehensive understanding of risks and mitigation efforts, including actions that can be taken to reduce civilian vulnerabilities and respond to incidents of civilian harm. Joint risk mitigation with host-state security forces can be particularly important, both to identify potential sources of harm to civilians and to enhance PoC efforts.

e. Effective risk mitigation requires sufficient insight to anticipate what can go wrong, based upon an accurate situational understanding as discussed in Chapter 2 and wisdom largely gained through experience. Achieving this insight is the first major challenge faced by military leaders. The second challenge is applying the appropriate leadership choices which include: (1) taking preventive measures to minimize as much risk as possible or (2) accepting risk and taking bold action that may achieve decisive results.

Conclusion

For a variety of reasons, military forces have too often proven inept at PoC or have themselves been threats to civilians. Even with highly capable and motivated military forces, however, the tradeoffs, challenges, and risks discussed above provide additional complexity to an already difficult endeavor. As discussed in the *PoC Military Reference Guide*, the military's contribution to PoC rests upon the ability to execute numerous tasks effectively. Whether or not the 45 tasks presented are necessary and sufficient will depend upon the specific circumstances. However applicable, this guide alone will not adequately protect civilians. PoC requires forces that are well-trained, disciplined, properly equipped, agile, and present in adequate strength and with appropriate capabilities. Units must be committed to PoC and must have leaders who have a sophisticated understanding of PoC considerations, cooperate effectively with other actors, and act decisively when necessary.

Annexes

- **A. PoC Task List**
- **B. The United Nations and PoC**
- **C. NATO and PoC**
- **D. PoC Training Curricula**
- **E. PoC Training Scenarios**
- **F. Legal Considerations**
- **G. Planning Templates**
- **H. Acronyms**
- **I. Glossary**
- **J. Bibliography**

Annex A. Protection of Civilians (PoC) Task List

- **Understand Civilian Risks**
 - Task 1: Understand the Operational Environment
 - Task 2: Understand the Actors
 - Task 3: Understand the Dynamics
 - Task 4: Understand Civilian Vulnerabilities and Threats
 - Task 5: Understand the PoC Strategy
 - Task 6: Conduct Intelligence Activities
 - Task 7: Manage Multi-Source Information
 - Task 8: Conduct Assessments

- **Protect Civilians during Operations**
 - Task 9: Plan for the Protection of Civilians
 - Task 10: Prepare for the Protection of Civilians
 - Task 11: Conduct Patrols
 - Task 12: Establish Checkpoints, Guard Posts, and Observation Posts
 - Task 13: Conduct Cordon and Search Operations
 - Task 14: Neutralize or Defeat Adversaries
 - Task 15: Secure Vulnerable Civilians
 - Task 16: Evacuate Vulnerable Civilians
 - Task 17: Conduct Interposition Operations
 - Task 18: Mitigate Civilian Casualties
 - Task 19: Respond to Reported Incidents of Civilian Harm
 - Task 20: Protect the Force
 - Task 21: Provide Command and Control
 - Task 22: Provide Administration and Logistics
 - Task 23: Integrate Fire Support
 - Task 24: Support the Protection of Children
 - Task 25: Support the Elimination of Conflict-Related Sexual Violence
 - Task 26: Conduct Combined Operations
 - Task 27: Support Relief for Displaced Persons
 - Task 28: Support Humanitarian Assistance
 - Task 29: Contain Public Unrest

○ **Shape the Protective Environment**

- Task 30: Manage Expectations
- Task 31: Conduct Information Activities
- Task 32: Conduct Engagements with Key Leaders and the Population
- Task 33: Support the Political Settlement
- Task 34: Coordinate with Other Actors
- Task 35: Build Partner Capacity
- Task 36: Establish and Maintain a Safe and Secure Environment
- Task 37: Support Good Governance
- Task 38: Support the Rule of Law
- Task 39: Support Social Well-Being.
- Task 40: Support a Sustainable Economy
- Task 41: Maintain PoC During Transitions
- Task 42: Support Security Sector Reform
- Task 43: Support Disarmament, Demobilization, and Reintegration
- Task 44: Support Transitional Justice
- Task 45: Support Community Building

Annex B: The United Nations and PoC

Overview—The 3 Tiers

a. PoC increasingly is a common task in mandates for UN peacekeeping missions. The UN Department of Peacekeeping Operations (DPKO) and Department of Field Support (DFS) have established a three-tiered framework for PoC. While military components support all three tiers, they are mainly concerned with Tier II.⁷⁹

- Tier I—Protection through Dialogue and Engagement
- Tier II—Provision of Physical Protection
- Tier III—Establishing a Protective Environment

b. The UN DPKO/DFS *Guidelines on the Use of Force by Military Components in United Nations Peacekeeping Missions* describe a four-phase tactical decision and response model. These phases are useful for framing PoC during training, planning, and operations.⁸⁰

- Phase 1—Assurance and Prevention
- Phase 2—Preemption
- Phase 3—Response
- Phase 4—Consolidation

PoC Training

The UN has separate operational and tactical PoC training packages and is in the process of replacing these with a set of integrated PoC training materials. UN guidance states that these training materials and national materials should be used for PoC training and exercises.⁸¹

ADAPTING THE *POC MILITARY REFERENCE GUIDE*

The tasks in the PoC Military Reference Guide may be regrouped to support the UN's approach to PoC and the use of force. Figure B-1 depicts the tasks that are likely to be significant in the different PoC Tiers and across the use of force phases. The tasks should be adjusted based on specific circumstances.

⁷⁹ DPKO/DFS, *Protection of Civilians: Implementing Guidelines for Military Components of United Nations Peacekeeping Operations*, 4-5. Also see DPKO/DFS, *Policy on the Protection of Civilians in United Nations Peacekeeping*.

⁸⁰ DPKO/DFS, *Guidelines on the Use of Force by Military Components in United Nations Peacekeeping Missions*, (New York: Department of Peacekeeping Operations and Department of Field Support, February 2017), 13-15.

⁸¹ United Nations, *DPKO/DFS Guidelines on Operational Readiness Preparation for Troop Contributing Countries in Peacekeeping Missions* (New York: Department of Peacekeeping Operations and Department of Field Support, January 2017), Annex B.

Tier/Phase/Task Matrix

	Assurance & Prevention	Preemption	Response	Consolidation
Tier 1 Protection through Dialogue and Engagement	1,2,3,5,7,30,31,32,33,34,44,45	1,2,3,4,5,6,7,8,30,31,32,33,34	3,4,5,30,31,32,33,34	1,2,3,4,5,7,30,31,32,33,34,44
Tier 2 Provision of Physical Protection	1,2,3,4,5,6,7,8,9,10,11,12,17,20,21,22,24,25,26,31,32,34,35,36,42	1,2,3,4,5,6,7,8,9,10,11,12,13,14,15,16,17,18,20,21,22,24,25,26,29,31,32,34	1,2,3,4,5,6,7,10,11,13,14,15,16,17,18,19,20,21,22,23,24,25,26,27,28,29,31,32,34	1,2,3,4,5,6,7,10,11,13,14,15,16,17,18,19,20,21,22,24,25,26,27,28,29,31,32,34
Tier 3 Establishing a Protective Environment	24,25,26,30,31,32,33,34,35,36,37,38,39,40,41,42,43,44,45	1,2,3,4,5,6,7,8,9,10,15,16,24,25,26,30,31,32,33,34,36	1,2,3,4,5,6,7,8,21,24,25,26,27,28,31,32,33,34,36	1,2,3,4,5,6,7,8,15,24,25,26,27,28,30,31,32,33,34,35,36,37,38,39,40,41,42,43,44,45

► **Figure B-1: Tier/Phase/Task Matrix** ◀

PoC Objectives and Activities

The following PoC objectives and activities are derived from a PoC Resource and Capability Matrix developed to assist missions in matching resources and capabilities with activities that support PoC Mandates.⁸² Of note, the matrix highlights the following as cross-cutting general requirements to achieve PoC objectives:

- Information and data management material resources.
- Mobility assets.
- Communication assets.
- Remote sensing assets and web-based information systems requirements.

POC Objective 1. Host state is supported in preventing and responding to violence against civilians, including by its own forces.

Supporting Activities

1.1. Support to political engagement and national ownership for POC through e.g. mediation, consensus-building and reconciliation between the parties and with the local population.

⁸² From United Nations Department of Peacekeeping Operations and Department of Field Support, “Protection of Civilian (POC) Resource and Capability Matrix for Implementation of UN Peacekeeping Operations with POC Mandates” (New York: United Nations, February 2012).

1.2. Support to Government-led Early Warning/Early Response mechanisms including through combined contingency planning.

1.3. Support to improved oversight, accountability of Host-State security institutions through institutional reform.

1.4. Support to training, capacity-building and screening of Host-State police and other law enforcement agencies and capacity-building of other criminal justice actors (e.g. courts, prosecutors' offices, detention and corrections facilities).

1.5. Logistical support to Host State in its response to violence against civilians, especially at the local level.

POC Objective 2. Mission response is informed by early warning and system-wide analysis of risks to civilians.

Supporting Activities:

- 2.1. Joint risk assessments and analysis.
- 2.2. Early warning/Early Response mechanism.
- 2.3. Strengthening local protection mechanisms including community alert mechanisms.
- 2.4. Monitoring and reporting on POC risks.
- 2.5. Community-oriented policing and problem solving (COPPS).
- 2.6. Patrols with a POC focus.
- 2.7. Long-range patrols.

POC Objective 3. The mission's reach into the community is extended, confidence between the mission and local communities, and authorities is built, civilian population's expectations are managed.

Supporting Activities:

- 3.1. Outreach to the community.
- 3.2. Public information campaigns.
- 3.3. Patrols with a POC focus.
- 3.4. Long-range patrols.
- 3.5. Community-oriented policing and problem solving (COPPS).
- 3.6. Monitoring and reporting on POC risks.

POC Objective 4. Attacks on civilians are deterred, safe passage/ access to resources is created.

Supporting Activities:

- 4.1. Temporary Operating Bases (TOBs) and Static Combat Deployments (SCD).
- 4.2. Checkpoints.
- 4.3. Set up of perimeter lighting around refugee and IDP camps.

- 4.4. Cordon and search.
- 4.5. Facilitation of humanitarian assistance and protection.
- 4.6. Monitoring and reporting on POC risks.
- 4.7. Patrols.
- 4.8. Long-range patrols.

POC Objective 5. Imminent threats of physical violence against civilians are addressed.

Supporting Activities:

- 5.1. Containment of violence/unrest through public order management.
- 5.2. Show or use of force and/or weapons to prevent and deter hostile elements.
- 5.3. Interposition of peacekeepers between population and hostile elements.
- 5.4. Noncombatant evacuation.
- 5.5. Mission crisis management.

Annex C: NATO and PoC

NATO POLICY ON PoC

NATO's policy on PoC, adopted in July 2016, states that "Protection of Civilians (persons, objects and services) includes all efforts taken to avoid, minimize and mitigate the negative effects that might arise from NATO and NATO-led military operations on the civilian population and, when applicable, to protect civilians from conflict-related physical violence or threats of physical violence by other actors, including through the establishment of a safe and secure environment." The policy includes the following elements:⁸³

- Civilian harm mitigation from own actions.
- Protection of civilians from others' actions.
- Support to humanitarian action.
- Lessons learned on PoC.
- Strategic communications.
- NATO Headquarters-level and joint exercises.
- Training of forces participating in NATO and NATO-led operations and missions.
- Training of local forces.
- Defence and related security capacity building.
- Partnership tools and programmes.

NATO PoC DEFINITION

NATO also defines PoC as "The activities conducted with the intent to safeguard non-combatant civilians from physical violence, secure their rights to access essential services and resources and to contribute to a secure and stable environment for civilians over the long term."⁸⁴

NATO PoC CONCEPT

a. NATO is currently developing a PoC military concept, as depicted in Figure C-1, to operationalize the NATO Policy by integrating PoC into the planning of NATO and NATO-led operations and missions.

b. As of this writing, NATO's concept includes three mutually reinforcing thematic lenses and lines of effort:

(1) **Mitigate Harm.** Focused on engaging the perpetrators of violence, this function uses military force or threat of force to prevent, stop, and/or deter actions that cause direct or indirect harm to civilians without causing more damage from one's own actions.

(2) **Facilitate Access to Basic Needs.** Focused on supporting the civilian population and aid providers, this function seeks to minimize own force impact on the local environment,

⁸³ North Atlantic Treaty Organization, *NATO Policy for the Protection of Civilians* (Brussels: NATO, 9 July 2016).

⁸⁴ NATO Terminology Data Base, Record #25928, available at <https://nso.nato.int/natoterm/content/nato/pages/home.html?lg=en>. This definition differs from that quoted from the 2016 NATO Policy for PoC, cited above.

infrastructure, resources, and population while enabling the civilian population's access to basic needs and services.

(3) **Contribute to a Safe and Secure Environment.** Focused on supporting and developing the host government and its institutions, this function seeks to reinforce local capabilities to reduce the chance of large-scale fighting and ensure rule of law, public order, human rights, and freedom of movement for all.

(4) A fourth element, **Understanding the Human Environment**, applies to all three of the other areas by providing a continuous process of observation, perception, and interpretation of a conflict or crisis that provides decision-makers with the necessary context, insight, and foresight to enable the effective planning and conduct of operations.

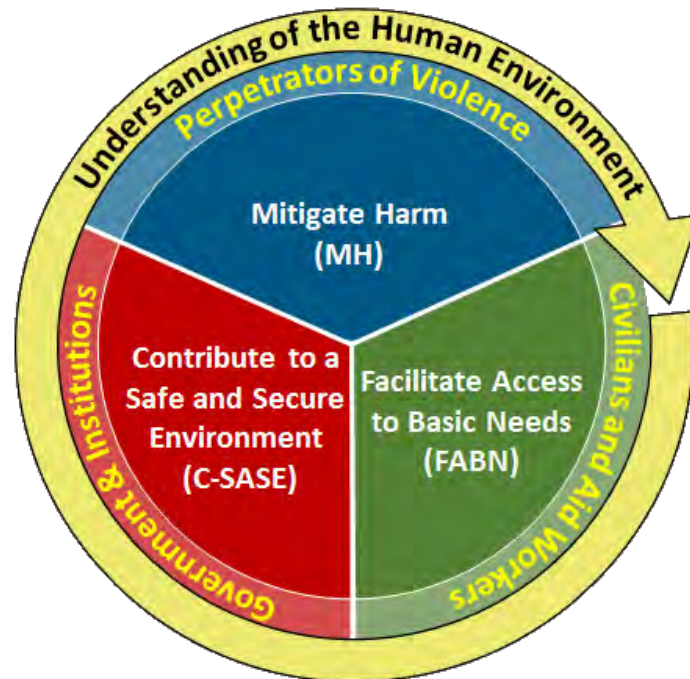

► **Figure C.1: Draft NATO PoC Concept** ◀

ADAPTING THE *POC MILITARY REFERENCE GUIDE*

The tasks in the PoC Military Reference Guide may be regrouped to support the NATO concept as follows:

- Understanding of the Human Environment. Tasks 1-8.
- Mitigate Harm. Tasks 9-26, 29.
- Facilitate Access to Basic Needs. Tasks 27, 28, 39.
- Contribute to a Safe and Secure Environment. Tasks 30-45

Annex D: PoC Training Curricula

a. PoC training is required for military personnel and units that participate in UN peacekeeping missions and may be appropriate for other audiences as well. This annex describes different programs of instruction that can supplement available UN training materials or be used to prepare for PoC outside of peacekeeping contexts.

b. Training audiences will have many competing demands for their time, including other training needs and operational requirements. PoC may be the dominant topic for some audiences, while for others it is merely a portion of another focus area, such as gaining understanding of peace operations. Consequently, some training needs can be satisfied with a brief overview of PoC, while others will require more extended coverage.

c. Many of the figures in the *PoC Military Reference Guide* can be used in slides to support PoC training. Trainers may elect to modify these graphics or translate them from English to another language. A Power Point file of the figures may be obtained by sending an e-mail to: allen.d.raymond2.civ@mail.mil.

POC PRESENTATION OR CLASS

a. An overview of PoC can be accomplished in one or two hours, or in even less time if necessary. This may be appropriate for unit commanders and staff officers with limited time to devote to the subject, or as general information to soldiers in a unit. It may also be delivered as a class to support a wider course on subjects such as peacekeeping, conflict prevention, or post-conflict recovery. It may also be delivered just prior to unit exercises in which PoC will be an important consideration.

b. A suggested outline for such a presentation is as follows:

- PoC Overview
- 3-45 PoC Framework
- Understand Civilian Risks
- Protect Civilians During Operations
- Shape a Protective Environment
- Tradeoffs, Challenges, and Risks
- Discussion

c. Trainers may add selected topics that may be of particular interest to the audience, such as conflict-related sexual violence, security sector reform, supporting humanitarian assistance, or the United Nations and PoC and cover the relevant sections in the *PoC Military Reference Guide*. If appropriate, the Executive Summary or Chapter 1 of the guide may be assigned as advance reading.

1-DAY POC COURSE

a. A one-day course on PoC may be incorporated within training programs at peacekeeping training centers or delivered to other audiences that require more detail on the subject.

b. Following is a suggested block of instruction with allocated times (excluding breaks and meal periods). Trainers may include selected topics tailored to the audience, such as the United Nations and PoC.

- PoC Overview 30 minutes
- 3-45 PoC Framework 30 minutes
- Understand Civilian Risks 30 minutes
- Protect Civilians During Operations 1 hour
- Shape a Protective Environment 30 minutes
- Tradeoffs, Challenges, and Risks 30 minutes
- Selected Topics 1 hour
- PoC Scenarios (see Annex E) 2 hours
- Discussion periods (throughout) 1 hour

c. If appropriate, Chapter 1 of the *PoC Military Reference Guide* may be assigned as advance reading.

3-DAY PoC COURSE

a. A three-day course may be suitable to train personnel who may themselves be expected to provide PoC training. It may also be a useful course for representatives from different countries or organizations, including nonmilitary participants.

b. Figure D-1 depicts an example schedule for a three-day PoC course.

Day 1	Day 2	Day 3
Welcome Keynote Speaker	Protect Civilians During Operations	PoC Scenarios or Staff Exercise
<i>Break</i>		
PoC Overview	Protect Civilians During Operations	PoC Scenarios or Staff Exercise
<i>Lunch</i>		
UN and PoC 3-45 Framework	Shape a Protective Environment	Selected Topics
<i>Break</i>		
Understand Civilian Risks	Tradeoffs, Challenges, and Risks Selected Topics	Capstone Speaker Conclusion

► **Figure D.1: Example 3-Day Course Schedule** ◀

c. Suggested reading assignments for this course are as follows:

- Day 1: Chapter 1, Chapter 2, Annex B

- Day 2: Chapter 3, Chapter 4, Chapter 5
- Day 3: Annex D, Annex E, Annex F, Annex G

5-DAY PoC COURSE

a. A five-day course provides more in-depth knowledge for trainers, personnel who will specialize in PoC in their duty positions, or others requiring expertise on PoC. Like the three-day version, it may be a useful experience for representatives from different countries or organizations, including nonmilitary participants.

b. Figure D-2 is an example schedule for a five-day course. It may be useful to conduct panel discussions or provide guest speakers during some of the sessions if appropriate experts are reasonably available. During the staff exercise, students may be assigned positions in a unit staff and develop a PoC contingency plan or conduct a tabletop exercise as discussed below.

Day 1	Day 2	Day 3	Day 4	Day 5
Welcome Keynote Speaker	Actors	Protect Civilians During Operations	Staff Exercise	Staff Exercise (Briefings)
<i>Break</i>				
PoC Overview UN and PoC	Dynamics Vulnerabilities & Threats	PoC Scenarios	Staff Exercise	Tradeoffs, Challenges, and Risks
<i>Lunch</i>				
3-45 Framework Legal Considerations	Protect Civilians During Operations	Shape a Protective Environment	Staff Exercise	Capstone Speaker Conclusion
<i>Break</i>				
Understand Civilian Risks Operational Environment	Protect Civilians During Operations	Shape a Protective Environment	Staff Exercise	

► **Figure D.2: Example 5-Day Course Schedule** ◀

c. Suggested reading assignments for this course are as follows:

- Day 1: Chapter 1, Chapter 2 (Tasks 1, 5, 6, 7, 8) Annex B, Annex F
- Day 2: Chapter 2 (Tasks 2, 3, 4), Chapter 3 (Tasks 9-23)
- Day 3: Chapter 3 (Tasks 24-29), Chapter 4, Annex E
- Day 4: Annex E, Annex G
- Day 5: Chapter 5

TABLETOP EXERCISES

a. Tabletop exercises (TTXs) are relatively easy to conduct and generally require limited resources. They may be conducted for the following beneficiaries:

- Students in a classroom.
- Practitioners, such as leaders of an organization or members of an organizational staff.
- TTX sponsors or researchers who convene a body of experts to examine an issue.

b. Training exercises, at all levels, generally reflect the role structure in Figure D-3. In some cases, an individual can fulfill more than one role. For example, an “observer” may also be a “controller,” and some “players” may also fulfill controller functions. During a low-resource TTX, a staff intelligence analyst may have the authority to fabricate information that is beyond the detail provided in the exercise scenario material.

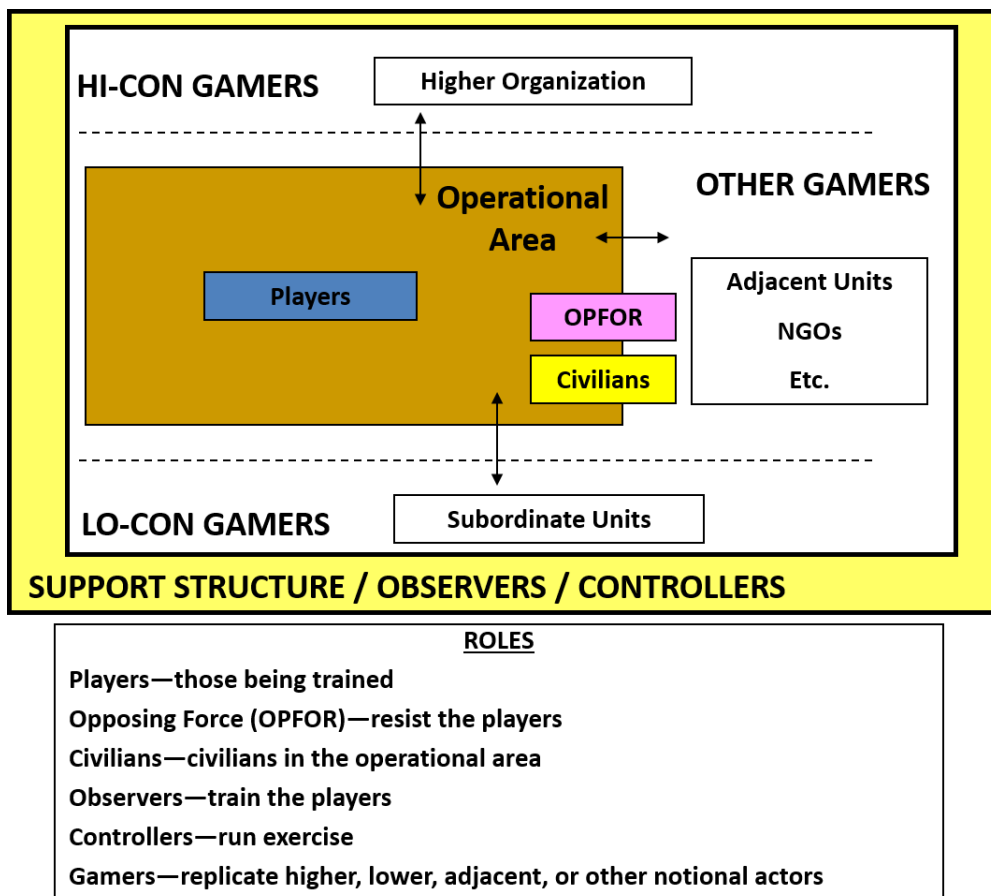

► **Figure D.3: Generic Exercise Structure** ◀

c. TTXs generally follow one of the following formats:

- Structured Discussion TTX. Participants are guided by a facilitator, and the TTX largely has the character of a seminar.
- Crisis Response TTX. Participants play roles (if students) or perform their actual duties (if practitioners) and respond to notional but realistic incidents that are injected into the TTX by controllers who drive the scenario.

- Contingency Planning TTX. Planners and other staff members follow a planning process develop a contingency plan to address a possible future situation. This TTX is largely internally driven, and senior leaders may participate sporadically during key points of the planning process.
- Synchronization TTX (or “rock drill”). Staff members “wargame” a focused activity to identify issues in detail or to rehearse a complex operation.

d. Annex G includes planning templates and wargaming tools that may be useful for staff-oriented TTXs.

POC FIELD TRAINING

Small unit tactical training exercises should include realistic PoC situations. Annex E contains suggested PoC scenarios that can be incorporated into field training.

AFTER ACTION REVIEWS

a. After action reviews (AARs) are essential to gain maximum benefit from TTXs and field training exercises. These may be conducted periodically during an exercise and at its conclusion.

b. A suggested format for an AAR is as follows:

- Commander/Leader Explanation of the Unit Mission and Plan
- Opposing Force (Adversary) Explanation of Adversary’s Mission and Plan
- Civilian Explanation of Civilian Threats and Vulnerabilities
- Event Discussion (select 3-5 events related to planning, preparation, or execution)
 - What Happened?
 - Why Did It Happen?
 - What Does Doctrine or Policy Say?
 - How Do We Improve?
- Functional Area Discussion
 - Command and Control
 - Intelligence
 - Operations
 - Protection (Force Protection and PoC)
 - Administration and Logistics
- Areas to Sustain
- Areas to Improve
- Commander/Leader Conclusion and Guidance

Annex E: PoC Training Scenarios⁸⁵

- Appendix 1: General Situation
- Appendix 2: Rules of Engagement
- Appendix 3: Scenarios
- Appendix 4: Scenario Handout

Scenario-Based Training

Scenarios help units train to handle potential situations effectively and efficiently. They allow the training audience to think through problems and work out responses before challenges actually occur, and can help identify preventive measures that can preclude problems from arising.

Contents

a. This annex includes situational background material and eight scenarios pertaining to PoC. The background material includes:

- General situation for the training unit, which is participating in a peacekeeping mission. Selected excerpts from the United Nations mandate (the mission may or may not be a UN mission, but in either case it is authorized by a UN Security Council Resolution).
- Rules of Engagement (ROE) Aide-de-Memoire.

b. Any additional situation that may be required should be based on the actual country of deployment for the training unit. Facilitators should be prepared to fabricate supplemental information in response to questions from the training audience.

c. Each of the eight scenarios contains the following sections:

- Situation.
- Questions for Discussion.
- Facilitator Notes.

Using the Training Scenarios

The training content may be delivered in two primary ways: (1) Group Discussions and (2) Situational Training Exercises. Group Discussions are conducted in a classroom setting, while Situational Training Exercises are integrated into small unit training events in the field. Both methods entail different stages for conducting the training.

GROUP DISCUSSION METHOD

a. **Stage 1: Preparation.** Facilitators become familiar with training material, prepare facilities, and prepare materials (e.g., slides, handouts).

⁸⁵ This annex is adapted from *Preparing to Prevent: Conflict-Related Sexual Violence Mitigation Scenario-Based Training* (Carlisle, Pennsylvania: Peacekeeping and Stability Operations Institute, 2014).

b. **Stage 2: Familiarization.** Facilitators orient training audience on CRSV, scenario-based training, the general situation, and the rules of engagement.

c. **Stage 3: Scenario Discussions.** Training audience may be separated into small groups or kept in one large groups. If in small groups, they may examine the same scenario(s) or different scenarios and may either be self-run or assigned their own facilitator. Small groups normally should present the results of their discussion to the entire training audience when it is reformed.

The training audience should be given the situation for each scenario as well as the questions for discussion. Facilitators should use the facilitator notes to guide discussions and emphasize key teaching points.

SITUATIONAL TRAINING EXERCISE METHOD

a. **Stage 1: Preparation.** Facilitators become familiar with training material, prepare training lanes, and prepare role-players.

b. **Stage 2: Familiarization.** Facilitators orient training audience on CRSV, the rules of engagement, the training situation and mission. The training unit (such as a patrol) conducts its mission planning and preparations.

c. **Stage 3: Training Event.** Training unit encounters CRSV scenario(s) while conducting its mission. For example, a patrol may encounter a role-player acting the part of a rape victim (Scenario 4). Unit responds.

d. **Stage 4: After-Action Review.** Facilitator uses facilitator notes to review the incident with the training unit. Unit Standard Operating Procedure (SOP) adherence (Scenario 1) and incident reporting (Scenario 3) may also serve as discussion points.

Points to Remember

- There will not always be “right” or “wrong” answers that apply in all cases.
- In some cases, rather than determining an answer, it may be more useful to identify the significant considerations that would affect decision-making or actions.
- Emphasize the learning points. Facilitators should not let lack of information side-track the training audience or tempt them not to take action. If necessary, fabricate additional information that forces them to make a choice.
- “What if...?” An effective technique for facilitators is to change the situation and discuss the implications. When force is employed, it is also good to ask what should happen if the situation escalates.
- Discuss the “before” and “after.” What could have been done beforehand to prevent the incident from happening? What should be done afterwards over the medium and long term?
- Modify scenarios as appropriate to support actual peacekeeping mission being trained for. If available, replace the country names, ROE, mandates, etc. in this document with the actual information for the particular peacekeeping mission
- Facilitators may only use a few of the scenarios offered in this document, and may create their own additional scenarios, such as those suggested later in the handbook.

Appendix 1 (General Situation) to Annex E (PoC Training Scenarios)

Your battalion is part of the multidimensional peacekeeping mission in Xland. The mission has military, police, and civilian components and cooperates closely with the UN country team. Your battalion's operational area is the state of West Calen, which is approximately 1,200 square kilometers and includes four medium-sized cities (30,000-50,000 inhabitants) and numerous small villages.

In the aftermath of a long civil war and with a newly formed government, Xland is impoverished, its government is struggling, and the national security forces are poorly trained and equipped. It has hostile relations with its more powerful neighbor Yland, which controls the disputed area of East Calen. There are several rebel groups and armed self-defense militias in the sector, and inter-communal violence frequently occurs between the Noot and Chim ethnic groups. The Noots are the dominant group in the country, although they are a minority in West Calen. West Calen is largely neglected by the Xland government, as it is a remote region far from the capital city of Skarpec. Widespread conflict-related sexual violence is one of the most urgent problems in the country.

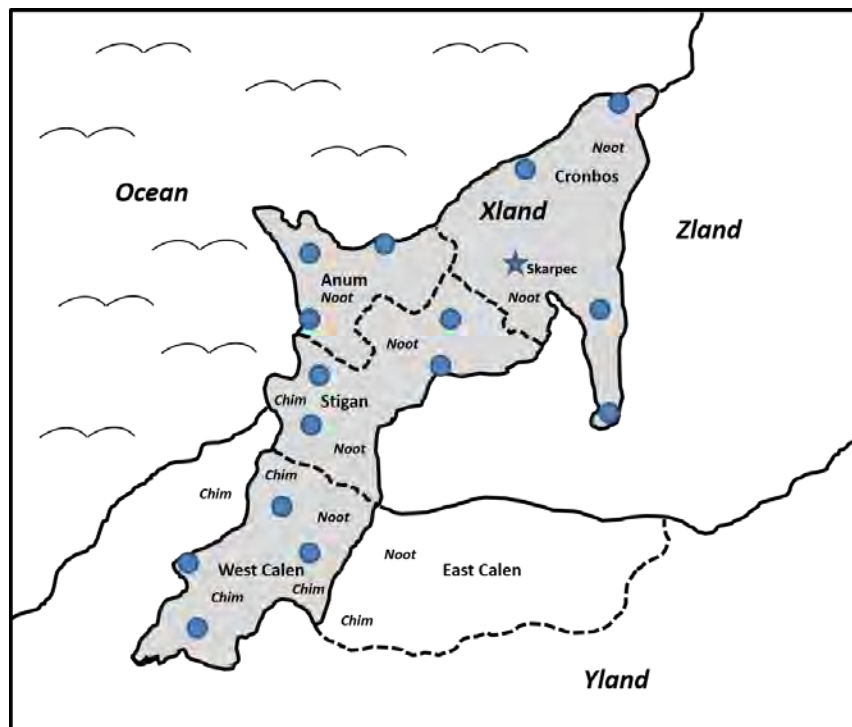

UN Security Council Resolution 5231, which authorizes your mission under Chapter VII of the UN Charter,⁸⁶ emphasizes the protection of civilians, particularly with respect to sexual violence. Some of the relevant portions of the mandate include the following guidance to the mission:

⁸⁶ Whether your mission is actually conducted by the UN, the AU, or a sub-regional organization, it is authorized by a UN Security Council Resolution.

a. Advise and assist the Government of Xland, including military and police at national and local levels as appropriate, in fulfilling its responsibility to protect civilians, in compliance with international humanitarian, human rights, and refugee law;

b. Deter violence including through proactive deployment and patrols in areas at high risk of conflict, within its capabilities and in its areas of deployment, protecting civilians under imminent threat of physical violence, in particular when the Government of Xland is not providing such security;

c. Protect civilians under threat of physical violence, irrespective of the source of such violence, within its capacity and areas of deployment, with specific protection for women and children, including through the continued use of Child Protection and Women Protection Advisers;

d. Exercise good offices, confidence-building, and facilitation in support of the mission's protection strategy, especially in regard to women and children, including to facilitate inter-communal reconciliation in areas of high risk of conflict as an essential part of long-term State-building activity;

e. Monitor, investigate, verify and report specifically and publicly on violations and abuses committed against children and women, including all forms of sexual and gender-based violence in armed conflict by accelerating the implementation of monitoring, analysis and reporting arrangements on conflict-related sexual violence and by strengthening the monitoring and reporting mechanism for grave violations against children, and to contribute to efforts to identify and prosecute perpetrators, and to prevent such violations and abuses;

f. Monitor, help investigate and report publicly and to the Security Council on violations of international humanitarian law and on abuses and violations of human rights committed throughout the nation, in particular by different armed groups, and to contribute to efforts to identify and prosecute perpetrators, and to prevent such violations and abuses, including through the deployment of human rights observers;

g. Provide specific protection for women and children affected by armed conflict, including through the deployment of Child Protection Advisors and Women Protection Advisors, and address the needs of victims of sexual and gender-based violence in armed conflict;

h. Take fully into account the need to protect civilians and mitigate risk to civilians, including, in particular, women, children and displaced persons and civilian objects in the performance of its mandate, where undertaken jointly with the Xland Defence and Security Forces, in strict compliance with the Human Rights Due Diligence Policy on United Nations Support to non-United Nations Security Forces (S/2013/110);

i. Further demands that all parties immediately cease all forms of violence, human rights violations and abuses, violations of international humanitarian law, including gender-based violence, rape and other forms of sexual violence, and violations and abuses against children in violation of applicable international law such as those involving their recruitment and use, killing and maiming, abduction and attacks against schools and hospitals, strongly urges the Government

to the fully and immediately implement its action plan to end and prevent child recruitment, and further strongly urges the opposition forces to fully and immediately implement their commitment to end grave violations against children, and calls for specific and time bound commitments to combat sexual violence.

Appendix 2 (Rules of Engagement) to Annex E (PoC Training Scenarios)

Rules of Engagement Aide-Memoire

Part 1: General Rules for Use of Force

1. The principles of minimum force and proportionality apply at all times. However, the level of force that is used may have to be higher than the level of the threat to avoid or minimize mission or civilian casualties or, in the case of offensive action, to ensure that the authorized objective is achieved.

2. Except where engaged in offensive action, you must make every reasonable effort, wherever possible, to control a situation through measures short of force. Your response should, if possible, be graduated and include personal contact and negotiation, voice and visual signals, radio or other electronic means of communication, maneuvers, charging of weapons and warning shots. You may use force, unarmed or armed, only if all other means to control the situation have failed, or such means do not hold out any promise of achieving your authorized objective.

3. You may open fire only on the order and under the control of the on-scene commander, unless there is insufficient time or opportunity for you to obtain an order from him/her.

4. Before opening fire, you must give a final warning, at least three times, in the local language as follows:

In Local Language: ("[PEACEKEEPING MISSION]: HALT OR I WILL FIRE")

You may open fire without warning only when (i) an attack is so unexpected that a moment's delay could lead to the death or serious injury of yourself, your fellow soldiers or other persons under the protection of the mission, (ii) if giving such a warning does not hold any promise of achieving your immediate authorized objective, or (iii) you are engaged in offensive operations.

5. If you must open fire:

- (a) Fire must be aimed and controlled. Indiscriminate fire is not permitted.
- (b) Automatic fire should only be used as a last resort, except (i) in the case of weapons that can fire in automatic mode only or (ii) where you are engaged in offensive operations.
- (c) Take all feasible precautions to avoid, and in any event minimize, collateral damage.
- (d) Except where you are engaged in offensive operations, fire no more shots than are necessary.

6. After firing:

- (a) Render medical assistance.
- (b) Record the details of the incident, whether or not casualties have occurred.
- (c) Report those details through the chain of command without delay.

7. When in doubt, always seek clarification from higher command.

Part 2: Specific Rules for Use of Force

You are authorized to use force, up to and including deadly force

- 1) to defend (i) yourself , (ii) your unit, (iii) other mission or associated personnel, (iii) members of the Xland government or security forces that your unit has been assigned to assist or support, (iv) individuals designated by the Head of Mission against (a) a hostile act or a hostile intent or (b) to resist an attempt to abduct or detain them.
- 2) to protect civilians, including IDPs, refugees, humanitarian personnel, and human rights defenders under imminent threat of physical violence from (i) members of illegal armed groups or (ii) members of Xland security forces.*
- 3) to protect (i) Mission facilities, installations, equipment, areas or goods and (ii) designated non-Mission facilities, installations, areas or goods against a hostile act or hostile intent that involves a grave threat to life or of serious bodily injury.
- 4) to protect key non-mission facilities, installations, areas, equipment or goods designated by the Head of Mission in consultation with the Force Commander, against a hostile act or hostile intent that involves a grave threat to life or of serious bodily injury.
- 5) against any individual or group that, through the use or threat of the use of armed force, limits or intends to limit the freedom of movement of (i) yourself, (ii) your unit, (iii) other mission personnel, (iv) humanitarian personnel, (v) members of the Xland government or security forces that your unit has been assigned to assist and support.*
- 6) to prevent or put a stop to the commission by (i) members of an illegal armed group or (ii) members of Xland security forces of a serious crime that involves a grave threat to life or of serious bodily injury to civilians.
- 7) to protect the cultural and historical sites in Xland, designated by the Head of Mission, against a hostile act or hostile intent.
- 8) to prevent the supply of weapons, related materiel, military advice and training and other supplies and logistic support to illegal armed groups.*
- 9) to prevent or suppress hostile activities or operations by illegal armed groups.*
- 10) to degrade, neutralize or eliminate the fighting or other operational capabilities of elements of illegal armed groups that have not agreed to disband and lay down their arms. This includes disarmament by force.*
- 11) To prevent forcible passage by individuals or groups through a roadblock, checkpoint or cordon whose establishment has been authorized by the Brigade or Battalion Commander, if there is a grave threat to life or of serious bodily injury.

- 12) to protect and stabilize key populations centers in support of the Xland government authorities.
- 13) to prevent the return of armed elements to key population centers in support of the Xland government authorities.
- 14) to apprehend or prevent the escape of those indicted by the ICC for war crimes and crimes against humanity in Xland.
- 15) against any person or group that, through the use or threat of the use of armed force, is preventing or demonstrating intent to prevent you or your unit carrying out lawful orders issued by a superior commander.

* When and where possible, seek permission from your immediate superior commander.

Appendix 3 (Scenarios) to Annex E (PoC Training Scenarios)

This appendix includes the following scenarios:

- Scenario 1: Unit SOP for PoC Incidents
- Scenario 2: Unit PoC Preparations
- Scenario 3: Unit PoC Incident Reporting
- Scenario 4: Patrol Encounter: Rape Victim
- Scenario 5: Patrol Encounter: Report of Abducted Children
- Scenario 6: Violence in IDP Camp
- Scenario 7: Patrol Encounter: Suspected Hostile Act in Progress
- Scenario 8: Checkpoint Encounter: Escaped Sex Slave
- Scenario 9: Mass Graves
- Scenario 10: Threats to Unit Interpreters

Units can modify the information these scenarios or develop other PoC scenarios with their own situations, questions for discussion, and facilitator notes. Possible additional scenarios include the following.

- What should a unit do if it encounters a child “bride” being kept by an older man? What if the “bride” has escaped and says she had been abducted?
- What should the unit do if a mother and infant appear at a mission base and the mother claims the father is a peacekeeper stationed there?
- What should the unit do if it encounters a male rape victim?
- What should the unit do with a baby if it was abandoned by a mother who was a rape victim?
- What should the unit do if it receives a report that mass atrocities may occur at a village in the area of operations?
- What should the unit do if a victim is rejected or threatened by the victim’s family or community?

Scenario 1: Unit SOP for PoC Incidents

SCENARIO 1 SITUATION

The battalion commander directs the staff to develop a Standard Operating Procedure (SOP) for handling PoC incidents, so that units may be better prepared to address PoC in a standardized but effective manner. At a minimum, the SOP should address how units should handle both victims and perpetrators when an incident is occurring or has occurred. Additionally, the commander wants the SOP to address systemic measures to help prevent violence against civilians in the area of operations. The commander wants the staff to provide an initial outline of this SOP tomorrow morning.

QUESTIONS FOR DISCUSSION

1. How can an SOP help units respond to PoC situations?
2. What are the main components that should be included in the SOP?
3. Develop a checklist of steps for handling civilian victims.
4. Develop a checklist of steps for handling perpetrators.

NOTE: A Standard Operating Procedure (SOP) helps units address likely situations efficiently. Some militaries use other terms, such as “Implementation Checklist” or “Implementation Guide.” Elements of a PoC SOP, such handling of victims or perpetrators who are detained, should be incorporated into PoC scenarios that are included in small unit situational training exercises.

SCENARIO 1 (UNIT SOP FOR PoC INCIDENTS) FACILITATOR NOTES

1. An SOP helps the battalion’s units respond to and manage information regarding similar situations that are likely to be confronted by its subordinate units. The SOP identifies the steps that should be taken so subordinate units can act quickly, efficiently, preclude the omission of important steps, and minimize the wasting of time when a unit is faced with a situation. It establishes accountability by establishing standardized procedures and expectations. It also supports continuity when units and personnel rotate. When all relevant parties are familiar with the SOP, it supports coherence and harmonization.

2. There are a variety of formats for an SOP. Following is an example that might be used for a PoC SOP:

- Purpose
- Conditions (When is the SOP applicable?)
- Definitions
- Procedures
 - 8-Step incident response procedure:
 - (1) Secure the area.

- (2) Protect victims/witnesses.
- (3) Provide medical assistance.
- (4) Take appropriate action against perpetrators.
- (5) Report to higher headquarters (company, battalion, brigade/sector, force headquarters, mission)
- (6) Battalion HQ contacts Women Protection Advisor (or women or child protection advisors, if appropriate and available) and arranges transportation if necessary
- (7) Contact local law enforcement
- (8) Arrange follow-up actions
 - Procedures for handling victims
 - Procedures for handling perpetrators
 - Preventive procedures
- Responsibilities
- Coordinating Instructions
 - Reporting
 - Parallel reporting
 - Coordination with other organizations
 - Other coordinating instructions
- References
- Appendices

3. A checklist for handling victims includes short, medium, and long-term guidance on protection, medical treatment, and interviews. It is important for peacekeepers to be responsive and to treat victims with dignity and compassion. In addition to providing immediate assistance, they must care for the victim until the time that a responsible authority assumes responsibility for the victim. Important steps include securing the victim, medical stabilization, and evacuation to a medical or other appropriate facility. Initial medical care may include treatment for shock. In rape cases, the victims should be evacuated to a medical clinic and receive post-exposure prophylaxis (PEP) to prevent HIV infection as soon as possible. Referral arrangements are under the overall coordination of the UN Country Team (if present) and the Xland government, and referral pathways should be provided by Women Protection Advisors. They are responsible for identifying the health service provider, and the unit is responsible for transporting the victim to this location. Consideration should be given to the victim's security after being transferred from the unit's control. Follow up actions include witness questioning, longer term care and reintegration, and information sharing. While these will likely be the responsibility of other organizations, the unit may be involved.

4. A checklist for dealing with perpetrators includes short, medium, and long-term guidance on engagement, detention, and disarmament. Violent acts should be stopped in accordance with the ROE. In many cases the soldiers should detain perpetrators. Detainees should receive humane treatment in accordance with international humanitarian law and international human rights law. Units should quickly transfer detainees to other appropriate authorities (usually the host-state police).

Scenario 2: Unit PoC Preparations

SCENARIO 2 SITUATION

Your battalion arrives in an unstable area with a history of violence against civilians including intercommunal violence, CRSV, and conflict between undisciplined security forces and armed rebel and criminal groups. The unit intends to conduct frequent mounted and dismounted patrols to maintain an effective presence and help improve security. The commander has directed the staff to prepare a PoC checklist to help patrols identify and report on civilian protection issues. In addition, the commander wants the staff to identify local actors, programs, and stakeholders that can help improve PoC.

QUESTIONS FOR DISCUSSION

1. What are indicators that patrols should look for to assess the local situation regarding PoC?
2. How can the headquarters systematically obtain and analyze information from patrols?
3. What other actors, stakeholders and programs are available to provide information and address CRSV in the unit's area of operations? How can the unit safely contact and coordinate with these other actors?
4. What are the regimens that leaders and patrols should take to support PoC?
5. What other measures should the unit adopt to help address PoC?

SCENARIO 2 (UNIT PO C PREPARATIONS) FACILITATOR NOTES

1. Patrols must do more than simply drive around; they should also interact with the population. They should look for indicators such as:

- Presence (or lack of presence) of women, their activities, and their demeanor (note: allowances should be made for cultural norms; for example, women may disappear from view when armed strangers such as a peacekeeping patrol arrive).
 - Are women present in expected numbers?
 - Do they appear to be engaging in normal activities (e.g., going to market)?
 - Do they appear secure (e.g., feel safe enough to be alone)?
 - Do they show evidence of victimization, injury, or mistreatment?
 - Are they willing and able to engage in conversations?
 - Does the populace and specifically women avoid certain areas?
 - Are there large numbers of pregnant women and girls?
 - Are females begging for food and promising sexual favors in return?
- Presence and activities of children.
- Activities and demeanor of males (towards women and towards the patrol).
- Indications that people are intimidated into being silent.
- Presence of internally-displaced persons or people who seem like they are displaced.
- Presence and capability of local police and other security actors.

- Do local authorities have control of the area? If there is little control, it is more likely that PoC is a problem.
- What are assessments from local police? (However, they may sometimes be perpetrators.)
- Ability of the village to report sudden threats and obtain responsive assistance.
- Recent history of violence against civilians and population concerns (obtained through interviews with inhabitants).
- Assessments of humanitarian personnel.
- Frequency of cases of violence against civilians, including CRSV, at local medical clinics or hospitals.
- Perspectives of local people who provide medical care, such as midwives, nurses, or traditional practitioners.
- Vacant homes.
 - Alternatively, people are afraid to leave their homes.
- Women and children sleeping “in the bush.”
- Signs of recent violence.
 - Human remains.
 - Burned/destroyed huts.
 - Dead livestock.
 - Injured personnel.
 - Shredded clothing on the ground.

3. Patrols should be given information collection requirements similar to those above, and debriefed upon completion of their mission. Collective debriefs are preferred, as different members of the patrol will observe different things. Based on patrol reports and other sources of information, the battalion staff should assess the civilian threat levels and monitor the situation over time. Assessments should be revised frequently, as the situation will change.

4. In addition to obtaining information from patrols, peacekeepers can obtain information from other actors. Information may also be obtained from the local and international media, and many research institutions publish useful on-line reports on all conflict areas.

a. Potential actors in the area of operations who can provide useful information may include:

- Civilian, Women, or Child Protection Advisors.
- UN Country Team.
- Humanitarian and development organizations.
- The Protection and Gender Clusters (if present)
- NGOs and international organizations such as Women for Women International; Amnesty International; International Rescue Committee; War Child UK
- Local hospitals and clinics; midwives; traditional medicine practitioners.
- Local police.
- Village and tribal leaders and elders.
- Civil society groups.
- Informants in armed groups; escapees from armed groups.

- Teachers.
- Missionaries and religious institutions.
- Border authorities.

b. These actors will often be vital to address PoC comprehensively. The battalion staff should record locations and contact information with these and other actors. In some cases, the actors may avoid direct contact with the unit, in which case the battalion may have to rely on intermediaries. The unit should be discrete about information obtained from these sources, as perpetrators may retaliate against them if they cooperate with the peacekeepers. Community alert networks can be established so that people can safely report PoC incidents; however, they may be too afraid of the perpetrators.

5. Patrols will need reliable communications equipment to submit reports. Surveillance equipment, including binoculars and night vision devices, and GPS (if available) will improve their effectiveness. They will need to be able to communicate with the population, and will require interpreters if they do not speak the local language. In some cultures, patrols should include female participants to interact with local women and girls. Patrol leaders should ensure their soldiers are fully briefed and maintain a professional and disciplined appearance. Patrols should rehearse actions such as encountering a civilian victim, providing medical treatment, and detention of perpetrators. Patrols should have cameras and other recording devices, although they must be careful to preserve confidentiality of victims. Personnel should be familiar with local culture and should be able to speak some phrases in the local language.

a. The unit can take other preparatory measures such as having a staff officer gain familiarity with host-state laws related to PoC, gender equality, and human rights. Even though these may not be practiced at the local level, they can provide a basis for changing norms. Units can support the conduct of regular councils or other meetings to address PoC and other human security issues, and encourage the active participation of women in these sessions. Units should train soldiers to make them more aware of civilian protection, and attempt to integrate women into small units, which will likely require additional training for such integration to be successful. PoC and CRSV should be included in information activities.

b. The capacity to move quickly by air, vehicle or on foot to areas of high incidence or potential flash points is crucial. Units need appropriate equipment, such as night vision devices, since most cases of sexual violence occur during the dark hours in unlit areas. Units need a rapid reaction capability, such as a quick reaction force that is able to deploy on short notice. Long-range extended patrols should be used during dark hours, with interpreters, and from mobile operating bases based in villages or in the field. Observation posts that maintain surveillance over known areas of violence against civilians and routes used by perpetrators can be effective.

c. Small units must be disciplined, professional, and proficient in soldier skills. Leaders must be proactive and demand high standards. The unit should be flexible and adaptive, able to conduct “soft soldiering” but being mentally and physically capable of quickly changing to using force according to the ROE. It should be fully willing and capable of implementing the presence-posture-profile (PPP) concept.

Scenario 3: Unit PoC Incident Reporting

SCENARIO 3 SITUATION

In the past two months, the peacekeeping battalion has received several reports from subordinate units regarding PoC incidents they have encountered. The battalion commander has noticed that excessive time is spent collecting information from the units and providing reports to the higher headquarters. The commander has directed the staff to create a report format to streamline this process and facilitate information management and assessment of trends.

QUESTIONS FOR DISCUSSION

1. What critical information elements should be collected to facilitate comprehensive yet efficient reporting and data management?
2. How can victims' personal identities be protected?
3. How should the report be formatted (are there any existing models that can be adopted)?
4. How can the information be used for trend analysis?
5. How should reports be modified based on subsequent actions or as new/revised information is acquired?
6. To whom should the reports be sent?

NOTE: Incident reporting can be incorporated into PoC scenarios that are used in small unit situational training exercises.

SCENARIO 3 (UNIT PoC INCIDENT REPORTING) FACILITATOR NOTES

1. Critical Information Elements.
 - Incident information: (number of victims, names, age, gender, ethnicity, location, perpetrators, witnesses, time of incident, description of incident and relevant circumstances)
 - Unit Information: (unit, mission, leader)
 - Mitigation efforts: (actions taken, treatment of victims, detention and disposition of perpetrators, evidence collection (e.g., photographs), agencies notified, measures taken to prevent future incidents)
2. Reports may have to use aliases to protect the identities of victims and witnesses who might face retaliation if they are exposed. However, the actual information must be preserved to support any subsequent prosecution efforts.
3. Reports should indicate:
 - Who (reporting unit, victims, witnesses, perpetrators, other relevant parties).

- What (describe incident and subsequent actions).
- When (date/time of incident and other associated events).
- Where (location of incident and other associated activities).
- Other (other relevant information, such as any background to the incident, contributing factors such as inter-communal violence, or recommendations to prevent future incidents).
- Follow-up information (updates that add relevant information, make corrections, or supplement the original report).

Other models that can be adopted include serious incident reports, police reports, or military spot reports. It may be beneficial to have a distinct format for a PoC incident report. On the other hand, it may be more efficient to have one format for serious incidents of any type. Generally, all mission units should use the same report format to support higher level analysis.

4. The battalion staff should be able to collect and analyze reports over time to identify patterns (e.g., high-risk locations, activities and profiles of perpetrators, and the effectiveness of preventive measures). Map displays, data bases, and periodic consolidated reports and assessments can facilitate this. Information from specific “incident reports” will be included in routine unit “situation reports” that are provided on a recurring basis (e.g., daily, weekly, monthly, etc.)

5. The battalion needs a system to preserve the original reports, yet permit follow-up reporting to account for new information or subsequent related developments that occur.

6. Reports will be sent to the higher headquarters, but provisions should be made for parallel reporting with other stakeholders (e.g., Civilian Protection Advisors, local police, other international organizations). The unit should follow established policies for sharing information with other organizations.

Scenario 4: Patrol Encounter—Rape Victim

SCENARIO 4 SITUATION

A squad-sized patrol is driving along a trail in an uninhabited area approximately three kilometers from the nearest village. They see a partially-clad woman crawling towards the trail and stop to render assistance. She appears to be in a state of shock, but is able to say that she was getting water for her family and was abducted by four armed men and gang-raped. The men wore different mixtures of military-type uniforms and spoke in a language she did not recognize. The rape occurred about 500 meters away from their current location, and she believes the rapists are probably still in that vicinity.

QUESTIONS FOR DISCUSSION

1. What actions should the patrol take?
2. What is the basis for action in the situation according to the mandate and ROE?
3. What should the patrol commander do if the perpetrators are members of (a) an armed rebel group, (b) Xland security forces, or (c) the military force?
4. What should higher level commanders do upon learning about the incident?
5. What can the unit do to prevent sexual violence in areas where there is no local law enforcement to protect women?

NOTE: This scenario is suitable for small unit situational training exercises.

SCENARIO 4 (PATROL ENCOUNTER: RAPE VICTIM) FACILITATOR NOTES

1. The patrol leader should secure the woman and report to the company headquarters. The patrol should attempt to locate the perpetrators and disarm and detain them, using force if necessary. The patrol medic should provide treatment to the woman, including treatment for shock. The woman should be evacuated to a medical clinic and receive post-exposure prophylaxis (PEP) to prevent HIV infection as soon as possible. Referral arrangements are under the overall coordination of the UN Country Team (if present) and the Xland government, and referral pathways should be provided by Women Protection Advisors. They are responsible for identifying the health service provider, and the peacekeepers are responsible for transporting the victim to this location.
2. The mandate and ROE (especially part 2-2) permit action to be taken against the perpetrators. By their actions they may be viewed as “imminent threats” to the victim and other women.
3. Regardless of their identities, the patrol should escort the detainees to its higher headquarters. If the perpetrators are rebels, members of criminal groups, or members of the Xland security forces they will be handed over to the local authorities for further disposition. If the

perpetrators are peacekeepers they will be transferred to their contingent which is responsible for enforcing the mission's SEA policy and handling any disciplinary matters involving its soldiers.

4. Higher headquarters may have to deploy additional forces to the scene and arrange for evacuation of the woman to a medical treatment facility. If the mission has Women Protection Advisors or similar officials, the unit should notify their office of the incident and facilitate a link-up with the victim. Local police authorities should be notified, and depending upon their competence the unit may transfer responsibility for the case to them.

a. These incidents should be reported to higher echelons, which in turn should emphasize with Xland authorities the extent of the problem and the need to sensitize Xland security forces regarding sexual violence.

b. Beforehand, the unit should have ensured that patrols are able to respond effectively to such situations. This includes training in the ROE, detention procedures, reporting, and handling of the victim. Patrols should have a medic or someone trained in advanced first aid.

5. Commanders should consider the use of night and helicopter patrols, quick reaction units, staying overnight in the area. Uniformed peacekeepers may work with humanitarian agencies, especially within the protection cluster, to establish referral networks for sexual violence victims to access medical and psychosocial support. Commanders should discuss with the local military and police authorities the security of roads where women have to transit for water, market, firewood, or other necessities.

Scenario 5: Patrol Encounter—Report of Abducted Children

SCENARIO 5 SITUATION

Kidnapping and sex trafficking is rampant in the area, and many children have been abducted and sold as sex slaves or child soldiers. A patrol is driving through the largest city in the area and stops at an intersection. Patrol members dismount, and within minutes a frantic man approaches them and says that there are abducted children, including his daughter, being held in a building across the street. He asks the patrol leader to rescue the children from their captors. There are two lethargic men in some sort of police uniforms standing nearby.

QUESTIONS FOR DISCUSSION

1. How should the patrol leader react to the request to rescue the girls from their kidnapers and what action should he take?
2. What is the basis for action in the situation according to the mandate and ROE?
3. What can military commanders do to prevent sexual violence in areas where there is no local law enforcement to protect women and girls, or when any law enforcement present is unwilling or unable to do so?
4. What actions should be taken at higher levels (e.g., battalion, brigade, sector, and mission) to prevent similar situations in the future?

The patrol enters the building and three men flee out the back door. The patrol hears children crying behind a locked door. They break down the door and find three girls huddled on the floor.

5. How can the victims be assisted?
6. Should the patrol pursue the men?

NOTE: This scenario is suitable for small unit situational training exercises.

SCENARIO 5 (PATROL ENCOUNTER: REPORT OF ABDUCTED CHILDREN) FACILITATOR NOTES

1. The local population has high expectations that the military force will provide protection, and the mission's credibility is at stake. The Patrol Leader should attempt to calm the man down, gain more information, establish a security perimeter, protect the man if necessary, report the situation, and attempt to get the local policemen to investigate. Assuming the Patrol Leader has probable cause to believe that action is required and authorized, and the local security forces are unable or unwilling to take action, the Patrol Leader should try to locate the kidnapped girls and, if necessary, disarm the perpetrators. They should be detained and handed over to the Xland Police, along with any evidence the patrol obtains. The girls should be brought to a safe location as soon

as possible, or handed over to responsible authorities. The situation should be reported to woman and child protection advisors in the mission.

2. The protection mandate including sexual violence is clear. Consideration must be given on the hostile intent and the historical precedent within the area of operations. The basis for action includes item 3 of the mandate and ROE part 2-2, which stipulates that soldiers are authorized to use force, up to and including deadly force, to protect civilians under imminent threat of physical violence. When and where possible, permission to use force should be sought from the immediate superior commander.

3. Governments hold the primary responsibility for ensuring the security of civilians in their territories. However, in conflict and post-conflict situations, the capacity of governments to live up to this responsibility may be limited. At times, the very government that is responsible for protecting the civilian population, including displaced people, may have caused the people to flee in the first place. In other cases, it has shown itself incapable of protecting its citizens from marauding rebel groups or sexual violence and persecution. In practical terms, this phrase stipulates that the military force should allow the authorities to take appropriate action whenever they demonstrate the intent and/or are capable of doing so.

a. However, in case local security forces are insufficient, ineffective or untimely, unit leaders must continually urge the host governments to take more robust measures to ensure the protection of civilians and potentially take action. They should consider ways to enhance safety around schools, orphanages, market places, and the routes to these locations. Military units may need to escort large groups of women and girls and maintain presence at these locations. Dismantling roadblocks or adding a peacekeeping presence and oversight role at checkpoints en route to schools and markets can reduce the risk of harassment and extortion. Units should also patrol during irregular hours, especially at nighttime.

b. The unit, in close cooperation with civilian and police components of the mission can disseminate public information about potential threats and suggest protective measures such as having women and children move in large groups. By expanding their presence, soldiers and local police can help secure these groups and protect villages from retaliatory raids by armed groups. A protective environment can be shaped by involving local leaders and civil society groups, improving the capacity of police, building local communities, and establishing communications networks. Effective civil-military cooperation is important at all levels.

4. Military leaders at all levels should discuss the security situation with host-state counterparts. They should closely monitor the performance of local police forces. They should report the results of these efforts to their own superiors to enlist higher up support. The battalion and brigade/sector commander should discuss possible measures with the mission's Human Rights Section, Child Protection Advisors, Women Protection Advisors, NGOs such as OXFAM, IRC, CARE, Save the Children, etc., and national civil society, including women's organizations, in the province capital.

For additional discussion: How to tackle situations in which the local population expects the mission to play a law enforcement role in the absence of adequate local authorities?

5. The patrol may have to provide first aid if the children are injured. Longer term assistance should be provided by other actors. If the mission has Child Protection Advisors, one should be contacted immediately. Village elders, local medical clinic and other applicable local dignitaries such as religious leaders, teachers, local women's organizations, human rights, civil affairs and Gender specialists and agencies with a protection mandate, such as UNICEF or UNHCR, can provide further assistance.

6. The patrol's first priority is safeguarding the victims. Once the men no longer pose a threat to the victims, it may not be within the mandate for the patrol to use force against the men. However, it is possible that in this situation the perpetrators will continue to be a threat against these and other children, in which case action against them may be legitimate. Preferably, their apprehension would be a matter for the Xland police.

Scenario 6: Violence in IDP Camp

SCENARIO 6 SITUATION

There have been reports of frequent incidents of sexual violence in a large IDP camp. Patrols have reported armed men freely entering and leaving the camp. Some humanitarian workers have told the country team that gangs have essentially taken over portions of the camp and that incidents of violence in the camp are increasing. Numerous women and girls have been sexually assaulted. Humanitarian supplies are being appropriated by the gangs, and the humanitarian workers themselves are occasionally accosted and forced to pay a “tax” to have access to aid recipients. This morning, a unit patrol found the naked corpses of two women in some scrub brush just outside the camp.

QUESTIONS FOR DISCUSSION

1. What action should the patrol leader take?
2. What can the peacekeeping unit do to prevent sexual violence in the IDP camp?
3. Are there any deterrent measures that the battalion/sector commander can take, such as increasing patrols around the camp?
4. What are actions that other agencies could take?
5. What is the basis for action in the situation according to the mandate and ROE?

NOTE: This scenario is suitable for small unit situational training exercises.

SCENARIO 6 (VIOLENCE IN IDP CAMP) FACILITATOR NOTES

1. The patrol should secure the immediate area, report the incident, and await the arrival of trained investigators. If they observe any potential witnesses they should attempt to question them. The other problems in the IDP camp are beyond the capacity of the patrol and will require extensive effort by the battalion and other actors.

2. There are various examples of good practices that can be drawn from other experiences. For example, ‘firewood patrols’ have been provided to women leaving camps, with the military escort being used to deter attacks and sexual harassment. Such trips need to be organized in advance so that there are sufficient soldiers or police available. These should be instructed to use minimum force, if strictly necessary, but should generally keep a low profile and take care not to antagonize people from neighboring areas. The area outside the site should also be subjected to regular day and night security patrols. However, the military normally should not patrol inside the camp, since this is a police function, unless there are exceptional circumstances and civilians are under threat (in which case military patrols inside the camp might be appropriate).

3. Protection should be provided for the camp or increased if protection is already provided. Patrols should also be increased, to include securing women who are collecting firewood.

Peacekeepers may interdict armed personnel who attempt to enter or exit the IDP camp. If it is possible to identify the group that the armed men belong to, the peacekeepers may be able to support camp administrators who attempt to negotiate with their leaders.

a. After discussing with the mission's civilian and police colleagues, the battalion commander should also liaise with the IDP camp representatives to address the issue of security for women within the camp itself: is there adequate lighting, are women vulnerable when using the latrines and showers, is the security for female-headed households sufficient? Ultimate responsibility for these issues rests with the national authorities, but the mission needs to provide accurate and up to date information about potential POC challenges, which can be used for advocacy purposes.

b. The mission should also consider how they can strengthen the capacity of the national police on this issue, through training, awareness-raising, mentoring and monitoring. The camp clearly has inadequate security, and the mission, camp administrators, local police, and Xland authorities must determine how to disarm the criminal groups and implement internal security measures such as searching for hidden weapons and providing secure living areas and latrine facilities for women.

4. UNHCR is usually the body responsible to establish and run the IDP camp, although other organizations may also be involved. They will be responsible for providing support to victims of sexual assault. They may request additional presence and assistance from the military force.

5. The direct protection of IDPs is clearly within the mandate of the mission and the ROE would apply when soldiers attempt to protect IDPs. The unit should attempt to coordinate its efforts with the agencies responsible for running the camp so that their activities are not jeopardized.

Scenario 7: Patrol Encounter—Suspected Hostile Act in Progress

SCENARIO 7 SITUATION

A patrol passes an isolated host-state police checkpoint and observes a policeman dragging a struggling woman from a car to the guard shack while two other policemen restrain the car's male driver at gunpoint. The patrol stops, and one of the policemen quickly comes over and states that the woman was the wife of the other policeman and that the vehicle's driver is her brother. However, the patrol leader is skeptical about this explanation.

QUESTIONS FOR DISCUSSION

1. What action should the patrol take?
2. What is the basis for action in the situation according to the mandate and ROE?
3. What are the long-term and systemic problems illustrated by this incident?
4. What can the unit do to deter sexual violence conducted by host-state security forces?

NOTE: This scenario is suitable for small unit situational training exercises.

SCENARIO 7 (PATROL ENCOUNTER: SUSPECTED HOSTILE ACT IN PROGRESS) FACILITATOR NOTES

1. The patrol leader has probable cause to doubt the policeman's explanation and conclude that the woman and her companion are at risk. If the patrol leader wants to question the policemen and civilians, they should be done separately to prevent the policemen from fabricating a story. If necessary, the patrol may use force to protect the woman and her companion. The higher headquarters may direct that the patrol detain the policemen; this will likely depend on understandings that are in place between the mission and the Xland government. Additionally, provisions may be necessary to secure the woman and her companion for an extended period of time.

2. The rules of engagement clearly authorize the use of force, if necessary in this situation. Inaction by the patrol would essentially condone such behavior.

3. The scenario indicates poor training and discipline in the Xland police forces, a culture of impunity, and the possibility that security forces are corrupt and prey upon the population.

4. The incident suggest that Security Sector Reform efforts are needed, including training, monitoring, and perhaps the creation of an Internal Affairs unit to combat such practices. Such incidents should be addressed in discussions with high-level leaders in the Xland security forces. Civilians should have methods to report such incidents without risk of retribution. Peacekeeping patrols should have a robust presence and be on the alert for this type of misbehavior by Xland

security forces. It must be a topic of emphasis between the mission and the local and national Xland authorities.

Scenario 8: Checkpoint Encounter—Escaped Sex Slave

SCENARIO 8 SITUATION

A young woman approaches a military checkpoint. The soldiers see that she has been injured and appears weak and dehydrated. Through an interpreter she states that she has been held against her will as a sex slave after being kidnapped by an armed group from her village several weeks ago. Two nights ago, she escaped from the base camp which appears to be located to the northwest. The armed group has 20-30 personnel, including child soldiers, and she states that there are 14 other women and girls being held there, as well as 4 boys who are also being held as sex slaves. Her village is located approximately 20 kilometers to the north.

QUESTIONS FOR DISCUSSION

1. What actions should the soldiers take?
2. What is the basis for action in the situation according to the mandate and ROE?
3. What action can be done in the long term to help others who are sex slaves in the area?

NOTE: This scenario is suitable for small unit situational training exercises.

SCENARIO 8 (CHECKPOINT ENCOUNTER: ESCAPED SEX SLAVE) FACILITATOR NOTES

1. The unit should secure the woman, medically stabilize her, and report the incident. A Women Protection Advisor should be contacted and assume responsibility for the woman, although this may happen after she is evacuated to a medical facility.

a. The woman should be afforded the opportunity to return to her village, but only if her security can be ensured as she has already been kidnapped from that location once before. Other considerations include her psychological condition and the reception she is likely to receive from her community.

b. The unit should also consider how to secure the release of the remaining captives. It will have to obtain more detailed information as regards the location and identity of the armed group. Negotiations should be attempted first (possibly via tribal leaders, NGOs, host-state authorities, or some other intermediary). If negotiations fail, a military operation to rescue the captives should be considered, and the unit should begin planning for this contingency as early as possible. Preferably, such an operation would be conducted by host-state security forces.

2. The mandate and ROE clearly permit the soldiers to assist the victims in this situation. However, civilian protection is the primary responsibility of the host state, and the mission should be cautious about encroaching upon the Xland government's jurisdiction unless the Xland authorities are unwilling or unable to act.

3. The Xland government and security forces eventually must establish legitimate governance and security over the country. Effective Security Sector Reform, Disarmament Demobilization and Reintegration, and Transitional Justice programs must be implemented. A political settlement may be necessary before armed groups are willing to disband.

Scenario 9: Mass Graves

SCENARIO 9 SITUATION

A patrol arrives at a remote village and is informed by an inhabitant that a massacre occurred there approximately six months ago. The bodies were buried in a mass grave less than a kilometer from the village. The inhabitant says there were other massacres in the area during this timeframe and other mass graves exist, although she does not know their locations.

QUESTIONS FOR DISCUSSION

1. What actions should the patrol and its higher unit take?
2. How might the other reported mass graves be located?
3. What are some unit considerations for handling the mass graves?

NOTE: This scenario is suitable for small unit situational training exercises.

SCENARIO 9 (MASS GRAVES) FACILITATOR NOTES

1. A mass grave is a single or several unit(s) containing deliberately interred remains of multiple individuals, usually as a result of a catastrophic event (e.g., war, execution, genocide, mass atrocities, or disease). There is no strict definition of how many bodies constitute a mass grave. Military units may discover mass graves in their areas of operations, and in some situations may be required to search for these locations.

a. Personnel must handle the discovery of unidentified human remains under any circumstance with extreme care. A mass grave is a crime scene and should be treated as such. Most countries have instituted procedures concerning the discovery and exhumation of human remains to determine if a grave is a result of a crime, is of archaeological value, or is the result of urban growth. The discovery of a mass grave site is different from a single grave only in that there is a stronger suspicion of foul play and it is more difficult to securely protect and study the scene and exhume the remains. In many cases, including mass atrocities, the mass gravesite is a crime scene. Soldiers must maintain, protect, and secure the environment so that investigators can gather evidence, gain intelligence, and build a legal case against the perpetrators that will hold up in court.

b. Mass gravesites often provide abundant intelligence and evidence regarding the circumstances surrounding the victims' deaths. Gravesites often provide information on displaced populations or missing persons. Because of advances in forensic science, each body tells a story. Information gathered from mass graves may prove mass atrocity crimes and may also support the prosecution of perpetrators. Additionally, casualties can be identified and surviving family members can be informed. Most importantly, following the forensic evaluation the remains can be returned to local or regional populations. The good will that this can engender towards the mission is immense. Conversely, not returning the remains has severe long-term repercussions.

c. In most cases, units (often with augmentation by external experts) will be expected to identify, secure, mark, and report mass grave locations. Teams of experts will normally conduct investigations. Upon discovery of a mass grave, personnel must inspect further to delineate its boundaries and to gather the information they will need when contacting higher headquarters and excavation personnel. Under no circumstances is any excavation to take place, as this would compromise the crime scene. Commanders should determine who has authority over the site, which may require identification of local authorities and consulting the status-of-forces agreement (SOFA), and inform their higher authorities. Legal advisors should be involved as appropriate.

d. Units can anticipate several potential problems including looting of the graves, natural disaster damage, vehicular damage, land mines, and unexploded ordinance. Additionally, bodies not fully decomposed present a biological hazard. Multiple graves could be in close proximity to the initial site. Careless handling of the site and associated information could hamper prosecution of individuals responsible for the mass grave.

e. Investigations must maintain proper respect for the human dignity of the victims, provide accurate information to support truth-finding and criminal prosecutions, and facilitate the eventual proper burial of the remains. Effective investigations are time-consuming, but there will likely be an imperative to work quickly. While the unit may have overall responsibility for operations at the site, qualified experts should be the only ones to conduct investigations.

f. Composite investigation teams may be made available, and may be subordinate to the political mission, the force headquarters, the host government, or some other organization. An investigation team may consist of fifteen-to-forty military or civilian personnel and may include the following specialists:

- Archaeologists.
- Forensic anthropologists.
- Archivists.
- Digital imagery experts.
- Evidence technicians.
- Coroners.
- Criminologists.
- Security Detachment.
- Communications.
- Medical personnel.
- Equipment operators.

g. These teams will likely have special equipment to support excavation, analysis, and documentation of the mass grave. Military units may be required to assist these teams by providing security, logistical support (billeting, rations, automation, transportation, refrigeration units), equipment support, or by conducting investigative tasks under expert supervision. Once the investigation is underway, it is likely that responsibility for the remains will be progressively transferred to a host-state organization, an international organization, or an NGO.

2. Soldiers should be aware that local inhabitants might be unaware of mass gravesites because they are usually created in secret. Even if there is a rumor of its existence, it is rare that local

inhabitants will know the exact locations of mass gravesites. There will normally be no specific individual responsible for monitoring or securing these sites.

a. Mass grave locations may be determined by piecing together information from a variety of sources including members of the population and host-state security forces, NGO personnel, satellite imagery, aerial reconnaissance, media reports, and ground reconnaissance. Spectral imagery may identify gasses that are emitted from decomposition of the remains.

b. It is important to understand the process by which victims were killed and mass graves created. For example, victims may have been transported to the general area by vehicle, then forced to walk to the killing site. In most cases the burial sites will be in secluded locations that are nevertheless relatively accessible by vehicles. The grave's excavation may have been accomplished by engineer equipment, in which case a potential signature would be a long trench with the width of a bulldozer blade or the scoop of a front loader along with tracks from the vehicles. Once such a pattern is known, aerial means can be particularly effective in locating additional mass gravesites.

c. Mass graves are likely to be hidden below the existing ground surface. However, if a soldier is aware of indicators, clues of burials may exist, even if erosion has not exposed the site. Items that may indicate a mass burial, especially in high concentrations, are:

- Depression in the shape of a trench or pit (after covering soil has compacted).
- Shreds or pieces of clothing sticking up from the ground.
- Human bones, such as phalanges (fingers and toes), or pieces of larger bones, such as the femur.
- Partially cremated remains.
- Shoes.
- Spent ammunition casings.
- Concentration of unusual vegetation types in a circumscribed environment.

3. Soldiers and units should adhere to the following guidelines:

DO

- Notify higher headquarters which will arrange for an appropriate team of experts to investigate the site.
- Get coordinates of the entire anticipated and actual site.
- Mark the spot temporarily where there is the highest concentration of material. Take a GPS coordinate and walk out from the center in at least four directions until the concentration of evidence material lessens dramatically or ceases to exist. Temporarily mark these spots as well, and take at least five GPS coordinates, if possible.
- Determine and draw the area's basic shape and size. After determining the sides of the burial area, measure the site with a measuring tape or by measuring strides. A single stride of an adult male of average height is approximately 3 feet long. In addition, record GPS coordinates, especially if it is obvious that the site is not perfectly formed or is composed of multiple graves.
- Document the site and its relationship to the area with digital imagery.

- Draw a strip map, recording location information and the distance to nearest town or identifiable monument or landscape feature. Annotate a minimum of five GPS coordinates and any identifiable landmarks, including geographical features. Include overall photographs and material on the surface. Include a scale and north arrow in all drawings and photographs. If a ruler or compass is unavailable, then placing a soldier (annotating his or her height) pointing towards the north would fulfill the minimum requirement for both a scale and a north arrow. For smaller objects, use anything of standard size (for example, a monetary bill or military ID card), placing it by the object being photographed.
- Report the grave and location to the unit commander as soon as possible. Any discovery of remains, especially those of a mass gravesite, may require the notification of local or provincial authorities and the medical examiner.
- Provide all documentation to the command, as well as to local authorities and professionals, investigating the burial. Public safety concerns will be raised with mass graves. Depending on the age of the grave and level of decomposition of the remains, biological health hazards can harm people working in or near the burials.
- Consult current SOFAs concerning mass graves. SOFAs differ in each host state and are critical in determining the mission's authority over mass graves in the host state.
- When appropriate, immediately notify local authorities and the medical examiner or coroner. The coroner will determine if the remains are a recent burial or of archaeological significance. The area may be labeled a crime scene or an archaeological site.

DON'T

- Do not collect any items from the site. The only exception to this is demining and removing unexploded ordinance.
- Do not excavate to "check it out" before making a report.
- Do not occupy the site. There may be additional graves in the area and the additional activity could disturb the burials.
- Do not use the area or the surrounding area as landing strips or pickup zones. The rotor wash will generate an unacceptable wind force that can unearth sites and sandblast exposed areas, prematurely eroding the site.

Scenario 10: Threats to Unit Interpreters

SCENARIO 10 SITUATION

The battalion has two local Calenese contracted interpreters, Ali and Shana, who were hired several months ago. Ali reports that he received a death threat yesterday evening. Shana also states that she has security concerns regarding her daily commute to the base.

QUESTIONS FOR DISCUSSION

1. What additional information needs to be collected from both interpreters?
2. What actions should be taken to solve the dilemma facing both interpreters?
3. What proactive/preventative measures can be taken to protect locally contracted civilians?

SCENARIO 10 (THREATS TO UNIT INTERPRETERS) FACILITATOR NOTES

1. Civilians include members of international and local organizations such as humanitarian workers and contracted employees that support the military force. Adversaries in complex operational environments may target civilians in “soft networks” such as those who work with military forces or who assist with stabilization and relief efforts. Perpetrators that attack soft networks do so to undermine stabilization efforts while simultaneously sending a message of fear into local communities. Threats against interpreters and other locally contracted civilians need to be taken seriously by both the military unit and the contracting company.

2. The unit should formally interview each interpreter and obtain the 5 W’s surrounding the unique security situation of each individual. A formal command investigation could be another appropriate course of action. The unit should attempt to gain answers to the following questions (Note: facilitator should fabricate realistic answers as appropriate):

- What family members do the interpreters live with?
- Is there a legitimate threat to the contracted civilians as well as their families?
- Are there recent or historical cases of soft networks being threatened and attacked in the region? If so, what patterns can be drawn from those cases?
- Have other organizations dealt with any similar situations?
- When was Ali’s threat received? How was it delivered? What did it say?
- Does Ali suspect or know who is behind the threat?
- Does Ali think the threat is credible; if so, why? Has he received any threats before?
- Does Ali use an alias or alibis with friends and family? What can the intelligence section determine by analyzing the threat and the situation?
- Has Shana received any threats? Have there been any new developments in her security situation?
- How does Shana get to work? What proactive measures has she been taking to protect herself?

3. The PoC control cell, if established, should help analyze threats. Periodic control cell meetings will help the unit to maintain current situational awareness of threats to civilians, including contracted employees and other local nationals that support stabilization efforts.

4. Prior to deployment, the unit should consider proactive measures to protect interpreters and other local nationals. Examples include techniques to protect their identity like using aliases, employing alibis, and providing on-base billeting.

5. Balancing long-term security goals with the immediate threats against civilians can be challenging. Politically, acknowledging the dangers to soft networks can be an affront to the local government. However, failure to protect and shelter these civilians can jeopardize relations between the military force and the local population. Failure to protect civilians that voluntarily work with friendly forces can negatively impact future as well as current operations in the area.

6. Units can help reduce the threats to interpreters by providing billeting space to reducing their commuting time. Base access and screening processes might expose interpreters to unnecessary harm if spoilers are able to observe them. If the security situation deteriorates, the contracting company could reassign interpreters to different units or areas. The unit should request interpreters that are not from the immediate area, as it might be difficult for local civilians to mask their true occupation in their hometowns.

Appendix 4 (Scenario Handout) to Annex E (PoC Training Scenarios)

Scenario 1 (Unit SOP for PoC Incidents). The battalion commander directs the staff to develop a Standard Operating Procedure (SOP) for handling PoC incidents, so that units may be better prepared to address PoC in a standardized but effective manner. At a minimum, the SOP should address how units should handle both victims and perpetrators when an incident is occurring or has occurred. Additionally, the commander wants the SOP to address systemic measures to help prevent violence against civilians in the area of operations. The commander wants the staff to provide an initial outline of this SOP tomorrow morning.

Scenario 2 (Unit PoC Preparations). Your battalion arrives in an unstable area with a history of violence against civilians including intercommunal violence, CRSV, and conflict between undisciplined security forces and armed rebel and criminal groups. The unit intends to conduct frequent mounted and dismounted patrols to maintain an effective presence and help improve security. The commander has directed the staff to prepare a PoC checklist to help patrols identify and report on civilian protection issues. In addition, the commander wants the staff to identify local actors, programs, and stakeholders that can help improve PoC.

Scenario 3 (Unit PoC Reporting). In the past two months, the peacekeeping battalion has received several reports from subordinate units regarding PoC incidents they have encountered. The battalion commander has noticed that excessive time is spent collecting information from the units and providing reports to the higher headquarters. The commander has directed the staff to create a report format to streamline this process and facilitate information management and assessment of trends.

Scenario 4 (Patrol Encounter: Rape Victim). A squad-sized patrol is driving along a trail in an uninhabited area approximately three kilometers from the nearest village. They see a partially-clad woman crawling towards the trail and stop to render assistance. She appears to be in a state of shock, but is able to say that she was getting water for her family and was abducted by four armed men and gang-raped. The men wore different mixtures of military-type uniforms and spoke in a language she did not recognize. The rape occurred about 500 meters away from their current location, and she believes the rapists are probably still in that vicinity.

Scenario 5 (Patrol Encounter: Report of Abducted Children). Kidnapping and sex trafficking is rampant in the area, and many children have been abducted and sold as sex slaves or child soldiers. A patrol is driving through the largest city in the area and stops at an intersection. Patrol members dismount, and within minutes a frantic man approaches them and says that there are abducted children, including his daughter, being held in a building across the street. He asks the patrol leader to rescue the children from their captors. There are two lethargic men in some sort of police uniforms standing nearby.

Scenario 6 (Violence in IDP Camp). There have been reports of frequent incidents of sexual violence in a large IDP camp. Patrols have reported armed men freely entering and leaving the camp. Some humanitarian workers have told the country team that gangs have essentially taken over portions of the camp and that incidents of violence in the camp are increasing. Numerous women and girls have been sexually assaulted. Humanitarian supplies are being appropriated by

the gangs, and the humanitarian workers themselves are occasionally accosted and forced to pay a “tax” to have access to aid recipients. This morning, a unit patrol found the naked corpses of two women in some scrub brush just outside the camp.

Scenario 7 (Patrol Encounter: Suspected Hostile Act in Progress). A patrol passes an isolated host-state police checkpoint and observes a policeman dragging a struggling woman from a car to the guard shack while two other policemen restrain the car’s male driver at gunpoint. The patrol stops, and one of the policemen quickly comes over and states that the woman was the wife of the other policeman and that the vehicle’s driver is her brother. However, the patrol leader is skeptical about this explanation.

Scenario 8 (Checkpoint Encounter: Escaped Sex Slave). A young woman approaches a military checkpoint. The soldiers see that she has been injured and appears weak and dehydrated. Through an interpreter she states that she has been held against her will as a sex slave after being kidnapped by an armed group from her village several weeks ago. Two nights ago, she escaped from the base camp which appears to be located to the northwest. The armed group has 20-30 personnel, including child soldiers, and she states that there are 14 other women and girls being held there, as well as 4 boys who are also being held as sex slaves. Her village is located approximately 20 kilometers to the north.

Scenario 9 (Mass Graves). A patrol arrives at a remote village and is informed by an inhabitant that a massacre occurred there approximately six months ago. The bodies were buried in a mass grave less than a kilometer from the village. The inhabitant says there were other massacres in the area during this timeframe and other mass graves exist, although she does not know their locations.

Scenario 10 (Threats to Unit Interpreters). The battalion has two local Calenese contracted interpreters, Ali and Shana, who were hired several months ago. Ali reports that he received a death threat yesterday evening. Shana also states that she has security concerns regarding her daily commute to the base.

Annex F. Legal Considerations

a. This annex summarizes key legal considerations regarding PoC. Three broad themes exist in this regard: the law of armed conflict (or international humanitarian law) (LOAC/IHL), international human rights law (IHRL), and international criminal law. Also discussed are examples of United Nations Resolutions from both the Security Council and General Assembly that involve language or concepts associated with the protection of civilians.⁸⁷

b. Military forces will require early and specific legal parameters on a variety of issues such as the authority to enforce domestic and international law, detain suspects, and the disposition of these suspects. Legal authorities and responsibilities will be situational and depend upon such factors as Status of Forces Agreements (SOFAs), the mission's mandate, host-state laws, international law, operational guidance, and the national laws of the military forces.

Law of Armed Conflict / International Humanitarian Law (LOAC/IHL)

a. Armed Forces conducting PoC operations will be expected to conduct themselves in accordance with LOAC/IHL. Mandates may provide unit commanders varying levels of direction regarding the use of force to ensure that the mission is carried out effectively and their own forces are protected, as well as other requirements. Guidance may vary for different contingents in multinational units.

b. The standard LOAC/IHL principles will continue to apply in PoC-related operations, though they must be understood in the complex political environment in which PoC will typically take place. Furthermore, different states may have differing views on whether LOAC/IHL, IHRL, or relevant national laws (or some combination) is appropriate in a given case, depending on the specific circumstances of the operation.

LOAC/IHL PRINCIPLES

a. PoC-related operations must, at a minimum, respect the four main principles of LOAC/IHL (necessity, proportionality, distinction, and humanity).

(1) *Necessity* requires that any military exercise of force be upon military objectives, and that the unintentional ill effects on civilians remain proportional to the military advantage gained by such an operation.

(2) *Proportionality* is correspondingly related, in that the amount of force used must not exceed the requirements necessary to achieve the desired military ends, and that these ends do not unnecessarily place civilians at risk.

(3) *Distinction* is the requirement that combatants and noncombatants (civilians) be distinguished, and civilians not be subjected to the use of military force.

⁸⁷ For a thorough examination of key documents and guidelines, see Bruce Oswald, Helen Durham, and Adrian Bates, *Documents on the Law of UN Peace Operations* (Oxford: Oxford University Press, 2010).

(4) *Humanity* compels that actions should not employ means that cause unnecessary suffering.

b. These are principles that have a consensus of agreement; however, universal practice of these principles is far less evident. PoC-related operations will need to maintain the highest level of respect for LOAC/IHL, especially regarding the issue of distinction between civilians and combatants. This principle in PoC may be especially difficult, and requires clear guidelines from higher levels of command. A mandate may afford unit commanders varying degrees of latitude regarding the use of force to ensure the mission is carried out effectively, and this may differ in multinational units.

International Human Rights Law (IHRL)

a. Depending on the mandate of a PoC-related operation, compliance with a variety of sources of international human rights law (IHRL) may be mandatory. PoC-related operations will be expected to be especially mindful of human rights norms in their own conduct. Additionally, human rights concerns may have provided a basis for the operation in the first place. The mandate under which the operation is conducted may require specific obligations to deter future violations. Unit commanders will need to be aware of the complex interplay between LOAC/IHL, IHRL, and relevant national law.

b. Prohibition of Torture. The prohibition of torture is defined under the Convention Against Torture, which has near universal agreement. Despite this, the widespread practice of torture, by itself or as part of a wider campaign of atrocity, is likely to be encountered by a PoC operation. Furthermore, the definition of what is torture, and what are lesser offenses or legal interrogation techniques, is debatable, and multinational units or operations will need to have some agreed-upon definition to operate effectively. The considerations on how these crimes should be punished—through the application of relevant domestic law, or referring the case to the International Criminal Court (ICC) or other *ad hoc* international criminal tribunal—will be an important high-level consideration. Unit commanders may be tasked with apprehension and/or detention of individuals accused of the violation of this prohibition, and the protection of civilians from further violations.

b. Prohibition of Slavery. The prohibition of slavery also occupies the highest tier of international human rights law. This prohibition includes slavery in all its forms, arises from Article 4 of the Universal Declaration of Human Rights, and is matched by a wide array of domestic and regional arrangements such as Article 4 of the European Convention on Human Rights. However, the practice remains widespread under various guises, and unit commanders will likely encounter slavery or forms of slavery within contexts of other human rights violations, failed states, or as part of a wider campaign of discrimination or atrocities. Human trafficking, sexual slavery, or similar examples of slavery can exist as parts of other atrocities or in the black market of a weakened state. Unit commanders may be tasked with apprehension and/or detention of individuals accused of the violation of this prohibition, and the protection of civilians from further violations.

c. Conflict-Related Sexual Violence. Discrimination on the basis of gender, prohibited under a variety of international and regional human rights frameworks such as Article 7 of the Universal Declaration of Human Rights, remains a major part of the socio-political framework of many

states. It may also be prohibited by domestic law, but enshrined in cultural practice. In the context of PoC, this may contribute to the higher likelihood of certain types of crimes such as mass rape, targeting of women, and other forms of gender-based violence. Strongly held cultural frameworks in a given state may contribute to or enforce various types of gender discrimination which are illegal under IHRL and counterproductive to a stable peace. Unit commanders may have to tread carefully between their legal obligations under their mandate and widely held cultural practices that may contribute to sexual violence. Unit commanders may be tasked with apprehension and/or detention of individuals accused of the violation of this prohibition, and may be required to protect civilians from further violations. Unit commanders should be especially aware of the possibility of misconduct on the part of their own forces, and rigorously prevent them.

Customary International Law (CIL)

This is one of the two primary sources of international law, the other being treaty-based law. CIL results from a general and consistent practice of states followed by them from a sense of legal obligation. CIL is composed of peremptory norms, which are principles of international law so fundamental that no nation may ignore them or attempt to contract out of them through treaties. Examples of peremptory norms include prohibitions of slavery, torture, genocide, or crimes against humanity. Accepted customary principles also include non-refoulement (protection of refugees from being returned to places where their lives or freedoms could be threatened) and immunity of visiting foreign heads of state.

International Criminal Law (ICL)

a. International criminal law (ICL) forms its own component of international law, separate from LOAC/IHL and IHRL. While the whole of ICL is not critical to PoC, there are specific concerns relevant to PoC operations.

b. International criminal law (ICL) is a recent addition to general international law, arising out of the trials at the end of the Second World War and forming into a coherent body of law only in the last twenty years as a result of case law promulgated by international courts and tribunals. ICL seeks to hold accountable those persons responsible for violating international human rights law and international humanitarian law. The precise boundaries and sources of ICL are difficult to pinpoint. What is clear is that most serious violations of international humanitarian law and international human rights law activate ICL processes and, accordingly, ICL will be of concern to PoC-related operations. The mandate under which PoC commanders operate will likely include answers to the following questions: Under what conditions will suspected perpetrators be apprehended? Who has the authority to apprehend? Where will perpetrators be held once apprehended? What tribunal will try the perpetrators (a domestic court, an *ad hoc* tribunal, or the International Criminal Court (ICC))? Multinational units or operations will likely have different national policies regarding ICL, and clear policies will need to be outlined as regards to the specific protocols to be followed.

c. From a legitimacy standpoint, the involvement of UN or multilateral actors in the prosecution of ICL is preferable to unilateral justice. Determination as to whether local criminal law or ICL should be the primary law applied will need to be made at high levels in a complex political environment. Military forces may be called upon to support inquiries or investigations into alleged crimes or apprehend accused individuals. Possible specific duties may include: witness

protection, the identification and investigation of evidence of crimes such as mass graves, and the detention of individuals accused of crimes.

Responsibility to Protect (R2P)

R2P is a normative framework for state and international actions regarding the prevention of, response to, and recovery from extreme situations of violence against civilians. R2P is generally restricted to situations involving genocide, war crimes, ethnic cleansing, and crimes against humanity. Rather than focusing on when outside actors may have the right to intervene in a sovereign state, the R2P framework emphasizes that states have a responsibility to protect their populations and that the international community has a responsibility to support states and, if necessary, to take action when states are unable or unwilling to live up to their responsibilities to protect.⁸⁸

Refugees and Internally Displaced Persons (IDPs)

a. Refugees and/or internally displaced persons very likely will comprise a major component of a PoC operation. The UN Convention Relating to the Status of Refugees and its 1967 additional Protocol requires that state parties to the treaty co-operate and assist the UN High Commissioner for Refugees (UNHCR) in its duties. The principle of non-refoulement, or the protection of refugees from forced return to the country from which they fled, is binding on all states. Unit commanders will be required to adhere to this principle, which will be especially relevant in operations near the borders of other states. Some may categorize persons who leave another country as “migrants,” in part to avoid the legal complications associated with “refugees.”

a. IDPs (who remain in their own state) are not covered under the Convention, and their state is legally responsible for their protection as citizens with the same rights as the non-displaced. At a minimum, this protection should ensure access to rights necessary to survival and to request aid where the state does not have sufficient resources—the aid will likely be requested through the UNHCR. PoC operations may be required to secure humanitarian aid distribution zones, and thus should make sure a working relationship with UNHCR exists. The UN Office for the Coordination of Humanitarian Affairs has published the “Guiding Principles on Internal Displacement” which compiles the obligations under international law on IDPs and recommendations for effectively working with UNHCR.

b. However, in many cases IDPs may be considered *de facto* refugees, and protection given to IDPs by the state or international refugee law may be insufficient. More expansive definitions of refugees that include situations of IDPs may be found in the 1969 OAU Convention and the

⁸⁸ In its original 2001 report, the International Commission on Intervention and State Sovereignty (ICISS) offered a three-stage R2P approach that included prevention, reaction, and rebuilding. R2P was subsequently endorsed at the 2005 United Nations General Assembly World Summit and later shaped into “three pillars” that include (1) the State’s enduring responsibility to protect its population; (2) the international community’s commitment to assist States; and (3) the responsibility of Member States to respond when a State fails to provide protection. See International Commission on Intervention and State Sovereignty, *The Responsibility to Protect* (Ottawa: International Development Research Center, 2001); Ban Ki-moon, address on “Responsible Sovereignty: International Cooperation for a Changed World” (Berlin, 15 July 2008); and UN General Assembly, *Implementing the Responsibility to Protect: Report of the Secretary General, A/63/677* (New York: The United Nations, 12 January 2009).

Cartagena Declaration of 1984, and unit commanders may operate under mandates that make reference to these more comprehensive documents.

Other Legal Considerations

a. **Obligations Arising From Local/Allied Forces' Conduct.** The military force must be aware of the actions of any allied or partnered security forces from the host state, other countries, or private security contractors. Other actors could commit war crimes or other atrocities, and the military force should in no way be complicit (i.e., direct, support, or condone such actions). The military force should conduct an inquiry (or investigate), document, and report allegations, and stop such crimes if they encounter them. Depending upon their rules of engagement, soldiers may be permitted to use force to accomplish this.

b. **Provision of Humanitarian Aid.** Legally, military units should generally provide emergency goods and services to needy recipients, when it is within their capability to do so and military necessity does not dictate otherwise. Politically and morally, it may be appropriate for units to set aside other missions to provide aid that is desperately needed. The military force should rarely interfere with humanitarian organizations that are attempting to deliver aid in areas controlled by adversaries or to populations that support adversaries.

c. **Status of Forces Agreements (SOFAs).** SOFAs are formal international agreements between a host state and the political authorities of foreign militaries in that state. SOFAs may regulate the numbers, types, and activities of these forces and may also address matters such as land and facility use; use of airspace, seaways, and the electromagnetic spectrum; use and conservation of natural resources such as water; customs and immigration procedures; compensation for services, injuries, or damage; and jurisdiction over members of the force who are suspected of crimes. SOFAs are not always in existence when a military force initially deploys.

d. **Military Justice Codes.** National militaries typically have codes of law that govern behavior and prescribe the administration of justice. Many aspects of such codes are relevant to PoC, including references to crimes, indiscipline, and failure to accomplish one's mission. Military justice is normally a national responsibility.

e. **Rules of Engagement (ROEs).** ROE explain the circumstances and limitations under which military forces use force. They may include guidance regarding the identification of hostile adversaries, procedures for controlling and using weapons, and nonlethal measures. In many cases ROE are authoritative directives that are backed by codes of military justice.

f. **UN Resolutions on PoC.** Peace operations and other legitimate military operations are usually associated with and derive mandates from the following chapters from the UN Charter:⁸⁹

- Chapter VI: Pacific Settlement of Disputes.
- Chapter VII: Action with Respect to Threats to the Peace, Breaches of the Peace, and Acts of Aggression.

⁸⁹ Charter of the United Nations (New York: The United Nations, 1945 with subsequent modifications), available at <http://www.un.org/en/documents/charter/intro.shtml>

- Chapter VIII: Regional Arrangements.

(1) Many United Nations documents and resolutions include language on PoC and are often useful references for unit commanders. In addition to those listed below, numerous UNSC Presidential Statements and Reports of the Secretary-General on PoC may help form a comprehensive picture of UN thought and expectations regarding PoC. UN Security Council Resolutions are often key sources of guidance on the purposes and constraints that apply in PoC missions. It is not only important for planners to have a broad sense of the mission set out in these resolutions, it is also essential that they consult judge advocates and other legal advisors for guidance on their implementation. United Nations Security Council Resolutions with PoC language include:

- S/RES/1973 – 17 March 2011 – Authorized “all necessary measures” to protect civilians in the Libyan civil war.
- S/RES/1998 - 12 July 2011 – Children and armed conflict.
- S/RES/1960 - 16 December 2010 – Created reporting mechanisms on sexual violence.
- S/RES/1889 - 5 October 2009 – Gender and sexual based violence, and mechanisms of reporting to implement S/RES/1325 on women, peace and security.
- S/RES/1888 - 30 September 2009 – Specific discussions of sexual violence and UN PKO mandates.
- S/RES/1820 - 19 June 2008 – Sexual and gender-based violence.
- S/RES/1674 - 28 April 2006 – Reaffirmed the responsibility to protect (R2P) and specifically its inclusion into peacekeeping mandates.
- S/RES/1325 - 31 October 2000 – First major resolution on women, peace and security. Incorporation of these concepts into PKO mandates.
- S/RES/1296 - 19 April 2000 – Reaffirmed UNSC commitment to PoC, requested further reporting on PoC from the Secretary-General.
- S/RES/1265 - 17 September 1999 – First PoC themed UNSC resolution.

(2) Fourteen UN peacekeeping operations have been given an explicit PoC mandate, typically to “protect civilians under imminent threat of physical violence”. These are: UNAMSIL, MONUC/MONUSCO, UNMIL, ONUB, MINUSTAH, UNOCI, UNMIS, UNMISS, UNISFA, UNIFIL, UNAMID, MINURCAT, MINUSMA, and MINUSCA. For a broad overview of the subject of PoC in the UN, see also the UN Aide Mémoire for the Consideration of Issues Pertaining to the Protection of Civilians in Armed Conflict, S/PRST/2009/1 of 14 January 2009.

Appendix 1 (Legal Instruments) to Annex F (Legal Considerations)

	What It Is	Relevance to PoC
Law of Armed Conflict (LOAC)	Also known as International Humanitarian Law, the Laws of War, or the Law of Land Warfare. LOAC includes (1) the “law of Geneva” which seeks to protect people who are not or are no longer taking part in the hostilities, and (2) the “law of the Hague” which establishes the rights and obligations of belligerents in the conduct of military operations, and limits the means of harming the enemy while also providing some protection for civilians and civilian objects.	During conflict, military units are bound by the LOAC and respect its requirements regarding military necessity, distinction, proportionality, and humanity; rules for treatment of prisoners; and rules for protected sites such as hospitals. Individuals who breach the laws, and in some cases their commanders who are found negligent, may be prosecuted; in grave cases, the charges could include war crimes.
International Human Rights Law (IHRL)	Body of international law concerning expected government treatment of individuals and groups, and entitlements of all persons (human rights). Based upon treaties, customs, and numerous non-treaty based principles and guidelines.	Among other things, human rights law prohibits actions such as genocide, torture, sexual exploitation, discrimination, and abuse of children. While many countries hold that IHRL applies during conflict, some countries hold that only LOAC is operative in such cases and IHRL does not apply.
Customary International Law (CIL)	Rules derived from general state practice and international community’s belief that such practice is lawfully required as a matter of law, and exist independent of treaty law. CIL is a key component of LOAC.	Many parts of LOAC have a basis in CIL. Military units conform to this framework by complying with LOAC and applying its principles.
Rome Statute	Binds signatory nations and provides for the International Criminal Court (ICC) to adjudicate law of war violations.	Over 100 countries have ratified; many of those that have not abide by its principles.
National Codes of Military Justice	Legal foundation for many militaries. Describe jurisdiction and procedures for military justice.	Some punitive articles may apply to PoC, such as the requirement to obey lawful orders and regulations.
Rules of Engagement (ROE)	Provide direction and guidance on the use of force; usually address self-defense, protection of civilians, detention, and restraint.	ROE should be designed to protect units and support their missions, while minimizing civilian harm. ROE are normally lawful orders to soldiers.
Status of Forces/Mission Agreement (SOFA/SOMA)	Negotiated legal agreement with the host government, establishing the privileges, immunities, and exemptions for foreign military personnel.	May oblige commanders to take certain actions in cases of civilian harm, and may grant jurisdiction to host nation.
Host-State Laws	Laws that apply to persons in the state, including foreigners not covered by SOFAs/SOMAs. Soldiers should comply with host state laws as long as they adhere to standards of international humanitarian law and human rights law.	Some host state laws may have PoC relevance and could apply to partners and other actors such as host state security forces, security contractors, multinational forces, governmental, and non-governmental organizations.

Annex G. Planning Templates

This Annex includes formats for planning templates that may be useful to support a standard military decision-making process such as that depicted in Figure G-1. The process can be adapted for planning missions and operations or to address potential PoC risk situations. Formats should be modified as necessary, based upon the unit's doctrine, organizational procedures, and the situation. Normally, PoC issues should be incorporated as much as possible within existing organizational structures and processes. Formats that are included in this Annex are:

- Appendix 1. Commander's Estimate
- Appendix 2. Mission Analysis
- Appendix 3. Planning Guidance/Directive
- Appendix 4. Course of Action Briefing
- Appendix 5. Course of Action
- Appendix 6. Course of Action Decision Briefing
- Appendix 7. Gaming
- Appendix 8. Operation Plan/Order (OPLAN/OPORD)
- Appendix 9. Backbrief
- Appendix 10. Situation Update
- Appendix 11. Comprehensive Protection of Civilians Strategy

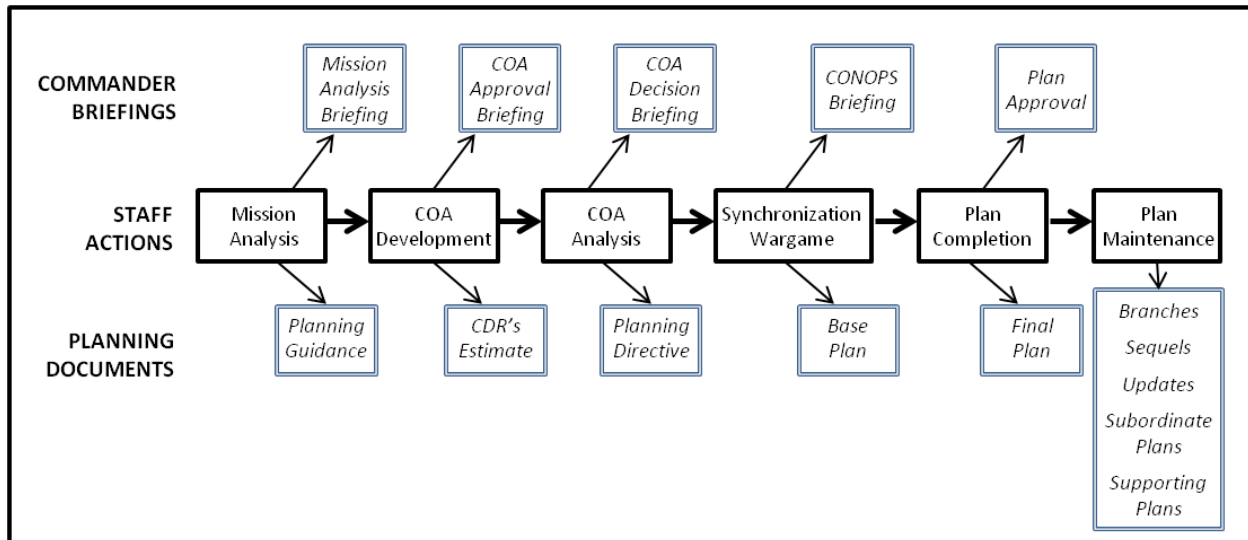

► Figure G-1: Example Planning Process ◀

Appendix 1 to Annex G (Planning Templates)
Commander's Estimate Format

A Commander's Estimate may be used to present a systematic analysis of a situation and a description of possible courses of action. It may be used to provide the Commander's formal appraisal to higher authorities, including political leaders. By ensuring that the estimate is kept current, it can also serve as a convenient format for a mission briefing to visitors and other audiences.

I. Background

1. Geography
 - (a) Area of Responsibility
 - (b) Area of Interest
 - (c) Regions / Key Countries
2. Relevant History
3. References (e.g., Strategic Guidance, mandates, treaties, other)

II. General—Security Environment

1. Overview
2. Challenges to Security and Stability
 - (a) Internal to Area of Responsibility
 - (b) External
 - (c) PoC Concerns
3. Operational Environment Assessment
 - (a) Geographic Factors
 - (b) Political & Diplomatic Factors
 - (b) Military Factors
 - (c) Economic Factors
 - (d) Social Factors
 - (e) Informational Factors
 - (f) Infrastructure Factors
4. Actors
5. Conflict Dynamics
6. Civilian Risks

III. Interests, Objectives, and Policies

1. Diplomatic
2. Informational
3. Military
4. Economic
5. Desired Goals

IV. Courses of Action

V. Issues and Recommendations

Appendix 2 to Annex G (Planning Templates)
Mission Analysis Briefing Format

A mission analysis may be conducted before a deployment, before a major operation, in conjunction with a known upcoming event or possible contingency, in response to a major change in the operational environment, or any other time when a new assessment is required. A mission analysis briefing is largely intended to provide information; however, the Commander may be required to approve certain results such as the mission statement, objectives, CCIR, or assumptions so that the staff and subordinate organizations can continue to plan effectively.

Mission Analysis Briefing Agenda

1. Purpose of Briefing
2. Agenda for Briefing
3. Situation/Background
4. Operational Environment
 - a. Areas of Operations/Influence/Interest
 - b. GPMESII Analysis (*Geographic, Political, Military, Economic, Social, Information, Infrastructure*)
5. Actors
 - a. Friendly Forces
 - (1) Higher Mission, Intent, Concept (if applicable)
 - (2) Forces and Other Assets Available
 - b. Adversaries
 - (1) Objectives
 - (2) Forces and Other Assets Available
 - (3) Courses of Action
 - c. Vulnerable Civilians
 - d. Other Actors
 - (1) Bystanders
 - (2) Negative Actors
 - (3) Positive Actors/"Partners"
6. End States & Objectives
7. Facts & Assumptions
8. Limitations

9. Center of gravity/critical factors analysis
 - a. Friendly
 - b. Adversaries
 - c. Vulnerable Civilians
 - d. Other Actors
10. Tasks
 - a. Specified
 - b. Implied
 - c. Essential
11. Proposed Restated Mission
12. Draft Commander's Intent (Purpose, End State, Key Tasks)
13. Commander's Previous Guidance (if any)
14. Initial Commander's Critical Information Requirements (CCIR)
15. Initial Risk Assessment
16. Top 5 Issues (optional)
17. Planning Timeline
18. Recommendations for Commander Approval
 - a. Objective(s)
 - b. Assumptions
 - c. Mission Statement
 - d. CCIR
 - e. Timeline
19. Commander's Guidance

Appendix 3 to Annex G (Planning Templates)
Planning Guidance/Directive Format

A “Planning Guidance” document may serve as a Warning Order for the staff, components, and supporting commands when a particular operation is being considered. At a minimum, planning guidance should be promulgated after the Mission Analysis Briefing, and it may be updated periodically as the plan is developed. It is converted to a Planning Directive when the level of planning is such that components should “be prepared” to execute the operation under consideration and thus begin its own parallel planning. The Planning Directive is eventually converted into the Basic Plan for the OPLAN. For branches, sequels, or other contingences, the Planning Directive is retained in the appropriate annex of the OPLAN, and converted to an Operations Order, or Fragmentary Order, as required. The format roughly parallels that for an OPLAN, with additions as noted below. Paragraphs may be expanded as appropriate; if so it is suggested that the subparagraphs in the OPLAN Base Plan format be used, to facilitate the eventual development of the OPLAN.

1. Situation. Explain actual situation, or anticipated or hypothetical situation when developing branches or sequels. Elaborate with appropriate subparagraphs from the OPLAN format.

2. Mission.

3. Execution. Include as appropriate:

- Commander’s Assessment
- Commander’s Guidance
- Commander’s Intent
- Concept or Proposed Courses of Action
- Tasks
- Coordinating Instructions
 - Plan Development
 - Planning Timeline and Milestones
 - Suspenses
 - Staff Planning Development Tasks
 - Briefing Procedures, Responsibilities, and Attendance
 - Planning Conferences
 - Backbrief Schedule and Formats
 - Liaison Instructions
 - Action Officer Designation
 - Web Site Posting and Access Instructions

4. Administration and Logistics. Elaborate with appropriate subparagraphs from OPLAN format.

5. Command and Control. Elaborate with appropriate subparagraphs from OPLAN format.

Chief of Staff Signature

Appendix 4 to Annex G (Planning Templates)
Course of Action Briefing Format

A Course of Action (COA) Briefing provides alternative courses of action for the Commander's approval, so that the set of COAs may be modified if necessary before the staff devotes further effort. This briefing is also used to obtain the Commander's approval of the decision criteria that will be used to assess the alternate COAs. A COA format is included in the next Appendix.

- Purpose
- Agenda
- General Updates (situation, area of operations, terrain, weather, GPMESII, actors, conflict dynamics, PoC considerations, etc.)
- Adversary Situation
 - Adversary Update
 - Adversary Courses of Action
- Friendly Situation
 - Higher Mission & Intent (or Operational Objectives)
 - Forces Available
 - Assumptions
 - Mission
 - Draft Commander's Intent
- Civilian Situation
 - PoC Risks
 - Civilian Organizations and Activities
- Review Commander's Previous Guidance
- Courses of Action (see Appendix 5—each COA includes:)
 - Rationale
 - Task Organization
 - Concept
 - Sketch
 - Phasing (as appropriate)
 - Major tasks for subordinates
- Proposed Decision Criteria
- Planning Timeline
- Recommendation
 - Approve Courses of Action
 - Approve Decision Criteria
- Commander's Guidance

Appendix 5 to Annex G (Planning Templates)
Course of Action Format

This Course of Action (COA) format may be used to depict alternative COAs. The selected COA can be developed further into a Concept of Operations (CONOPS).

COA XX: *Short Distinctive Title.*

Rationale: *Briefly explain the intent or justification of this course of action; what differentiates this from other potential COAs?*

1. Task Organization. *Explain organization of forces.*

2. Pre-Operation. *Briefly explain preparatory or preventive actions that pertain to this COA.*

3. Operation. *Include sketch(s). Explain how this course of action unfolds—tell the story. Identify the major actions, tasks, and/or priorities for the command and its components, and how forces are allocated among them. Systematic frameworks such as “shaping-decisive-sustaining,” “operational functions,” or “lines of effort” may be helpful in organizing the COA. Explain the role of enablers and significant actions of supporting commands, allies, or other actors, particularly as they relate to the protection of civilians.*

4. Post-Operation. *Briefly explain the relevant activities.*

5. Other. *Briefly describe logistical plan, command relations, information activities, or other significant topics.*

COAs should be:

- **Feasible:** Unit must be able to accomplish the mission within the available time, space and resources.
- **Acceptable:** The tactical or operational advantage gained by executing the COA must justify the cost in terms of resources (especially casualties or the mitigation of civilian harm).
- **Suitable:** A COA must accomplish the mission and comply with the commander’s planning guidance.
- **Distinguishable:** Each COA must differ significantly from the others.

Appendix 6 to Annex G (Planning Templates)
Course of Action Decision Briefing Format

A Course of Action (COA) Decision Briefing provides the results of the staff's analysis of alternative COAs, to include gaming results, advantages and disadvantages of different COAs, and comparison against the decision criteria. This briefing provides a recommended COA as well as any recommended improvements.

- Purpose
- Agenda
- General Situation
 - GPMESII Updates
 - Actor Updates
 - Dynamics Updates
 - PoC Issues
- Adversary Situation
 - Adversary Update
 - Adversary Courses of Action
- Friendly Situation
 - Higher Mission & Intent
 - Forces Available
- Civilian Situation
 - PoC Risks
 - Civilian Organizations and Activities
- Assumptions
- Mission
- Draft Commander's Intent
- Review Commander's Previous Guidance
- Review of Courses of Action
- Analysis of Each Course of Action
 - Gaming Results
 - Advantages and Disadvantages
- Comparison of Courses of Action (Decision Matrix)
- Recommended Course of Action (and any dissenting views)
- Risk and Mitigation
- Recommendations
 - Approve Recommended Course of Action
 - Approve Revised CCIR
 - Approve Commander's Intent
- Commander's Guidance

Appendix 7 to Annex G (Planning Templates)
Gaming Format

Gaming⁹⁰ is conducted to support the analysis of a course of action (COA Gaming) or to support the detailed development of a plan based upon a COA that has been selected (Synchronization Gaming). The gaming format is also useful to support Tabletop Exercises and operation rehearsals. COA Gaming is often abbreviated and focused on the main phases or elements of a plan. Synchronization Gaming is lengthier, as tries to cover as many important details as possible. Synchronization Gaming helps to anticipate PoC challenges and other problems and work through solutions, while ensuring that all participants understand the overall plan and are aware of each other's actions.

Gaming is conducted by using the following:

- **Maps.** Maps of different scales may be required. They may be paper maps, computerized maps, or both. Maps should be visible to the gaming participants. Sandtables may be constructed for increased visibility.
- **Pieces.** Stickers, computerized symbols, or other items should represent friendly and adversary units, other significant entities (such as clusters of civilians), and events. As a general rule, military units should be portrayed two levels down (i.e., brigade gaming should portray companies), although it may be necessary to depict smaller units.
- **Participants.** All key organizations should be represented. Representatives should be able to address their organization's capabilities, limitations, probable courses of action, and concerns. Other participants should be designated to represent other actors (such as adversaries, host-state organizations, or NGOs). A facilitator should direct the gaming, adjudicate contentious issues, and move the discussion along as necessary.
- **Synchronization Matrix.** The synchronization matrix may be a large chart or a computer spreadsheet. The matrix consists of a horizontal axis that represents time, phases, or major events and a vertical axis that includes the items to be addressed during the time blocks. The matrix is used to guide the game and record results. A scribe should be designated to enter information into the matrix. Simple matrices are used for COA Gaming, while more detailed matrices are used for Synchronization Gaming (see Figures G-2 and G-3).

⁹⁰ Also referred to as "wargaming" or "mission-gaming."

	Prevention / Preparation	Time Period 1 Pre-Emption	Time Period 2 Response	Time Period 3 Consolidation
Military Force				
Action				
Reaction				
Adversary				
Action				
Reaction				
Other Actors				
Unit A				
Unit B				
Unit C				
Unit N				
Other Notes				
COA Issues				

► **Figure G-2: COA Gaming Matrix** ◀

Gaming progresses by turns, which are determined by the titles of the vertical columns. In some cases, a game may represent hours or days; in others, the turn could represent an entire phase of an operation. For example, turns could be based upon the phases depicted in the UN “Use of Force Decision and Response Model” (Prevention, Pre-emption, Response, and Consolidation). Each turn consists of the following steps:

1. Summarize situation at beginning of turn.
2. Explain Military Force actions for the turn.
3. Explain adversary actions for the turn.
4. Explain Military Force reactions to the Adversary.
5. Explain Adversary actions to the Military Force.
6. Appropriate representatives sequentially address subsequent rows.
7. Discuss and record decision points, risks, CCIR, etc.

8. Identify issues requiring future resolution.
9. Summarize situation at end of turn (e.g., unit locations and status, casualties, estimated time required to complete the turn).

It may be necessary to table some issues for future resolution to maintain the discussion's momentum. Some questions that arise during the gaming may be researched by staff officers while the gaming continues, with the answers provided at a later point.

Gaming results may be recorded and explained using the synchronization matrix and map-based "snapshots" that depict the situation and critical events at selected times.

Protection of Civilians Military Reference Guide

	Prevention / Preparations	Time Period 1 Pre-Emption	Time Period 2 Response	Time Period 3 Consolidation	Contingency A	Contingency B
TIME:						
Objectives						
ACTIONS						
Force Actions						
Adversary						
Military Force	Prevention	Pre-Emption	Response	Consolidation	Contingency A	Contingency B
Unit A						
Unit B						
Unit C						
Unit D						
Unit E						
Unit F						
Other Actors	Prevention	Pre-Emption	Response	Consolidation	Contingency A	Contingency B
Host State						
UN						
Vulnerable Civs						
Para-militaries						
NGOs						
Higher HQ						
Lines of Effort	Prevention	Pre-Emption	Response	Consolidation	Contingency A	Contingency B
1. Sit Und						
2. Public Info Act						
3. Unity of Effort						
4. Mil Ops						
5. Force Gen/Sust						
6. BPC						
7. Safe/Sec Environ						
8. Gov/ROL						
9. Soc/Econ						
Other	Prevention	Pre-Emption	Response	Consolidation	Contingency A	Contingency B
Decision Points						
CCIR						
Phase LOEs						
Branches						
Risks						
Force Arrivals						
Issues						

► Figure G-3: Synchronization Gaming Matrix ◀

Gaming can produce other planning products, such as a Decision Matrix that identify anticipated critical decision points. Figure G-4 depicts Decision Point #3 from such a matrix, including the conditions associated with a potential decision point, the actions to be taken, and the risks of acting or not acting.

 Attack Perpetrator Base Camp	<u>Adversary Conditions</u> •Location, identities confirmed •Preparing for attacks on civilians •Leadership present	<u>Actions</u> •Bde Cdr Decision •1 st Bn (-) assault force •C Co, HN Bn security force •HN Bn subsequently remains in area •PIA emphasizes legitimacy of operation because of past atrocities	<u>Risks of Acting/Not Acting</u> •Potential Civilian Casualties •Force casualties •Mission Failure •Perpetrators conduct retributive actions •Perpetrators continue attacks on civilians •Force loses credibility •Perpetrators gain momentum and support
	<u>Friendly Conditions</u> •Forces available •Egress routes secured •HN security forces integrated in operation		

► Figure G-4: Sample Decision Matrix Extract ◀

Appendix 8 to Annex G (Planning Templates)
Operation Plan/Order (OPLAN/OPORD) Format

Following is an example format for an operation plan or order, which should be modified based upon the unit's established procedures. Much of the content below (such as many of the annexes) may be omitted for brevity.

Issuing Headquarters
Date

Title of OPLAN/OPORD

() References:

1. SITUATION.

a. General

- (1) Background
- (2) Policy Goals
 - (a) Policy Goals
 - (b) Desired Endstate
- (3) Constraints/Restraints/Limitations

b. Operational Environment

- (1) Area of Responsibility
- (2) Area of Interest
- (3) Operational Area
- (4) GPMESII Considerations

c. Actors

- (1) Military Forces
 - (a) Higher Organization(s) Mission, Concept, and Intent
 - (a) Critical Factors
 - (b) Multinational/Allied/Partnered Forces
 - (c) Supporting Commands and Agencies
- (2) Adversaries
 - (a) Critical Factors
 - (b) Adversaries' Desired End States
 - (c) Adversaries' Strategic Objectives
 - (d) Adversaries' Operational Objectives
 - (e) Adversaries' Courses of Action
 - (f) Adversaries' Concept of Operations
 - (g) Adversaries' Logistics and Sustainment
 - (h) Other Adversary Forces/Capabilities
 - (i) Adversary Reserve Mobilization
- (3) Vulnerable Civilians
 - (a) Identities
 - (b) Status

- (c) Critical Factors
- (4) Other Actors (bystanders, negative actors, positive actors)
 - (a) Host State
 - (b) International Organizations
 - (c) Nongovernmental Organizations
- d. Dynamics
- e. Assumptions
- f. Legal Considerations
 - (1) International Law and Mandates
 - (2) Domestic Law
 - (3) Law of Armed Conflict
- g. Risk
 - (1) PoC Risks
 - (2) Other Mission Risks

2. MISSION.

3. EXECUTION.

- a. Concept of Operations
 - (1) Commander's Intent
 - (2) General
 - (3) Deployment
 - (4) Employment
- b. Tasks
- c. Coordinating Instructions

4. ADMINISTRATION AND LOGISTICS.

- a. Concept of Support
- b. Logistics
- c. Personnel
- d. Information Activities
- e. Civil Affairs
- f. Meteorological and Oceanographic Services
- g. Geospatial Information and Services
- h. Medical Services

5. COMMAND AND CONTROL.

- a. Command
 - (1) Command Relationships
 - (2) Command Posts
 - (3) Succession to Command
- b. Command, Control, Communications, and Computer (C4) Systems
- c. Coordination with Other Actors

Annexes

- A – Task Organization
- B – Intelligence
- C – Operations
- D – Logistics
- E – Personnel
- F – Information Activities
- G – Civil Affairs
- H – Host State Support
- J – Command Relations
- K – Command, Control, Communications, Computer Systems, and Networks
- L – Legal
- M – Geospatial Information and Services
- N – Environmental Considerations
- P – Protection of Civilians
- Q – Health Services
- R – Reports
- S – Special Operations (published separately)
- T – Consequence Management
- U – Spare (e.g., Transitions, Rules of Engagement, Engineering, or other)
- V – Interagency Coordination
- W – Contingency Plans (CONPLANs)
- X – Execution Checklist
- Y – Risk Assessment
- Z – Distribution
- AA – Spare
- AB – Spare

Appendix 9 to Annex G (Planning Templates)
Backbrief Format

A backbrief is used so that a lower commander can present his or her plan to a higher commander. It is helpful for all lower commanders to attend each other's backbriefs so that they can achieve better mutual understanding of plans, expectations, concerns, and supporting tasks.

- Purpose
- Agenda
- Adversary Situation
- Friendly Situation
 - Higher Mission & Intent
 - Task Organization
- Civilian Situation
 - PoC Risks
 - Civilian Organizations and Activities
- Facts
- Higher Mission & Intent
- Assumptions
- Constraints
- Tasks
- Mission
- Intent
- Concept of Operation
 - By Phase
 - Sketches
 - Support Required from Supporting Commands
 - Support Provided to Supported Commands
- Issues
- Recommendations
- Commander's Guidance

Appendix 10 to Annex G (Planning Templates)
Situation Update Format

Following is an example format for a situation update. It can be used to update key leaders routinely (e.g., twice daily) and to provide key information from a command to other audiences.

- Background
- Country Profile (if needed)
- Recent Events
- Situation Changes
 - Operational Environment (GPMESII)
 - Actors
 - Military Forces
 - Adversaries
 - Vulnerable Civilians
 - Others (bystanders, negative actors, positive actors)
 - Dynamics
 - Strategic Guidance and Mandates
 - Strategic Logic of Perpetrators
 - Impact of Operations
 - Other
 - Civilian Vulnerabilities and Threats
 - Opportunities
 - Challenges
 - Risks
- LOE Status/Progress/Setbacks
- Upcoming Events
- Issues and Recommendations

Appendix 11 to Annex G (Planning Templates)
Comprehensive Protection of Civilians Strategy

Following is a template for a PoC Strategy, adapted from that developed and in use by the UN. The format can be further modified by military forces as well as multidimensional missions.

A. Purpose and Scope of the Strategy

1. Purpose.
2. Scope
 - a. Compliance
 - b. PoC Objectives
 - c. Existing Protection Strategies
 - d. Review Procedures

B. Analysis of PoC Risks

1. Vulnerabilities
2. Threats
3. Risk Assessment

C. PoC Activities for Risk Mitigation

(Risk, Activities, Lead Actors, Supporting Actors)

D. Information-Gathering and Sharing System

E. Early Warning Systems and Crisis Response

F. Analysis of Mission Capacities, Resources, and Limitations

G. Roles and Responsibilities of Organizations and Other Protection Actors

1. Host-State Authorities
2. Local Communities
3. Non-State Armed Groups
4. Military Force/Mission
5. International Protection Actors, Independent Organizations, and NGOs

H. PoC Coordination Mechanisms

1. Host-State Authorities
2. Local Communities
3. Non-State Armed Groups
4. Military Force/Mission
5. International Protection Actors, Independent Organizations, and NGOs

I. Expectation Management

J. Monitoring and Reporting on PoC

1. Monitoring
2. Reporting (Internal and External)
3. Lessons Learned and After-Action Reviews

Annex H. Acronyms

BPC	Building partner capacity
C2	Command and control
CC	Critical capability
CCIR	Commander's critical information requirements
CIMICC	Civil-military cooperation center
COA	Course of action
COG	Center of gravity
CR	Critical requirement
CRSV	Conflict-related sexual violence
CV	Critical vulnerability
DDR	Disarmament, demobilization, and reintegration
DP	Displaced person
FFIR	Friendly force information requirements
GPMEISII	Geographic, political, military/security, economic, social, information, infrastructure
IHL	International humanitarian law
IHRL	International human rights law
JMAC	Joint mission analysis center
JOC	Joint operations center
LOAC	Law of armed conflict
LOEs	Lines of effort
MOB	Mobile operating base
MOE	Measure of effectiveness
MOP	Measure of performance
NGO	Nongovernmental organization
PIR	Priority information requirements
PoC	Protection of civilians
R2P	Responsibility to Protect
ROE	Rules of engagement
RSOI	Reception, staging, onward movement, and integration
SGBV	Sexual and gender-based violence
SOFA	Status of forces agreement
SSR	Security sector reform
UN	United Nations

Annex I: Glossary

Adversaries. Actors that impede mission accomplishment, including perpetrators who threaten civilians as well as those who directly oppose the military force.

Center of Gravity (COG). Primary sources of physical or moral strength, power, and resistance.

Children. The Convention on the Rights of the Child defines a “child” as any person under the age of 18 (0-17 inclusive). The Rome Statute of the International Criminal Court establishes as a war crime the conscription or enlisting of children under the age of 15 years into State armed forces or non-State armed groups and using children to participate actively in hostilities (see Articles (2)(b)(xxvi) and 8(2)(e)(vii)).

Civilian Casualty Mitigation. Measures to avoid or minimize unnecessary civilian casualties and reduce the adverse impact of those that occur.

Conflict-Related Sexual Violence (CRSV). Violent acts of a sexual nature, often undertaken for strategic or tactical purposes, that include rape, sexual slavery, enforced prostitution, forced pregnancy, enforced sterilization, indecent assault, trafficking, inappropriate medical examinations, and strip searches.

Critical Capability (CC). Primary abilities which merits a Center of Gravity to be identified as such in the context of a given scenario, situation, or mission.

Critical Requirement (CR). Essential conditions, resources, and means for a center of gravity to achieve its critical capability.

Critical Vulnerability (CV). Critical requirements, or components thereof, that are deficient, or vulnerable to neutralization or defeat in a way that will contribute to a center of gravity failing to achieve its critical capability.

Human Security. The protection of fundamental individual rights from severe and widespread threats and adverse situations.

Humanitarian Space. Ability of humanitarian actors to operate and advocate on behalf of populations, based upon security, access, and their engagement with and perceptions of local actors.

Information Activities. Informational efforts that promulgate messages, inform audiences, and/or influence perceptions regarding the situation and particularly the objectives and actions of the military force.

Lines of Effort (LOEs). Mission-related elements that are necessary and generally sufficient for success. In other words, if all of the LOEs are performed effectively, the mission should be successful. Conversely, if any of the LOEs are unsatisfactory, then the mission would be at risk.

Mass Atrocities. A mass atrocity refers to widespread and often systematic acts of violence against civilians by state or non-state armed groups, including killing, causing serious bodily or mental harm, or deliberately inflicting conditions of life that cause serious bodily or mental harm.

Negative Actor. An actor that provides support to adversaries or otherwise contributes to threats against civilians.

Peace Operations. Activities conducted by a military force that normally is an impartial actor, present with the host state and the major parties to a conflict, and mandated to monitor compliance with appropriate resolutions and agreements, support reconciliation, or facilitate transition to legitimate governance.

Positive Actor. An actor that performs a constructive role regarding PoC but operates independently from the military force.

Protection of Civilians (PoC). Efforts to reduce civilian risks from physical violence, secure their rights to access essential services and resources, and contribute to a secure, stable, and just environment for civilians over the long-term.

Responsibility to Protect (R2P). A normative framework for state and international actions to prevent, respond to, and recover from extreme situations of violence against civilians.

Security Sector Reform (SSR). The development of legitimate and accountable security institutions that provide effective internal and external security.

Transitional Justice. Judicial and nonjudicial measures that address past human rights abuses by truth establishment, criminal prosecution, reparations, memorialization, or institutional reform.

Annex J. Selected References

- Giffen, Alison. *Addressing the Doctrinal Deficit: Developing Guidance to Prevent and Respond to Widespread or Systematic Attacks Against Civilians*. Washington, DC: The Stimson Center, Spring 2010.
- Holt, Victoria and Tobias C. Berkman. *The Impossible Mandate? Military Preparedness, The Responsibility to Protect and Modern Peace Operations*. Washington, DC: The Stimson Center, September 2006.
- Holt, Victoria and Glyn Taylor, with Max Kelly. *Protecting Civilians in the Context of UN Peacekeeping Operations: Successes, Setbacks and Remaining Challenges*. New York: The United Nations, 2009.
- International Committee of the Red Cross. *Enhancing Protection for Civilians in Armed Conflict and Other Situations of Violence*. Geneva: ICRC, September 2008.
- International Forum for the Challenges of Peace Operations. *Considerations for Mission Leadership in United Nations Peacekeeping Operations*. Stockholm, Edita Västra Aros AB, 2010.
- Kelly, Max. *Protecting Civilians: Proposed Principles for Military Operations*. Washington, DC: The Stimson Center, 2010.
- Kjeksrud, Stian; Alexander W. Beadle, and Petter H.F. Lindqvist. *Protecting Civilians from Violence: A Threat-Based Approach to Protection of Civilians in UN Peace Operations*. Kjeller/Oslo: Norwegian Defence Research Establishment (FFI) and the Norwegian Defence International Center (NODEFIC), 2016.
- Sewall, Sarah; Dwight Raymond, and Sally Chin. *Mass Atrocity Response Operations (MARO): A Military Planning Handbook*. Cambridge, MA: The President and Fellows of Harvard College, 2010.
- The Sphere Project. *Humanitarian Charter and Minimum Standards in Humanitarian Response* (2011 Edition). Northampton, UK: Belmont Press Ltd, 2011.
- Strange, Joe. *Centers of Gravity and Critical Vulnerabilities: Building on the Clausewitzian Foundation So That We Can All Speak the Same Language* (Second Edition). Quantico, VA: Marine Corps University Foundation, 1996.
- Strange, Joe and Richard Iron. "Understanding Centers of Gravity and Critical Vulnerabilities," www.tecom.usmc.mil/cce/student/pme/csc, 2004.
- Stromseth, Jane; David Wippman, and Rosa Brooks. *Can Might Make Rights? Building the Rule of Law after Military Interventions*. Cambridge: Cambridge University Press, 2006.

United Nations. *A New Partnership Agenda: Charting a New Horizon for UN Peacekeeping*. New York: UN Department of Peacekeeping Operations and Department of Field Support, 2009.

United Nations. *Addressing Conflict-Related Sexual Violence: An Analytical Inventory of Peacekeeping Practice*. New York: UN Development Fund for Woman and Department of Peacekeeping Operations, June 2010.

United Nations. *Civil Affairs Handbook*. New York: UN Department of Peacekeeping Operations and Department of Field Support, 2012.

United Nations. *DPKO/DFS Guidelines on Operational Readiness Preparation for Troop Contributing Countries in Peacekeeping Missions*. New York: Department of Peacekeeping Operations and Department of Field Support, January 2017.

United Nations. *DPKO/DFS Guidelines: Use of Force by Military Components in United Nations Peacekeeping Operations*. New York: UN Department of Peacekeeping Operations and Department of Field Support, 1 February 2017.

United Nations. *DPKO/DFS Policy on the Protection of Civilians in United Nations Peacekeeping*. New York: UN Department of Peacekeeping Operations and Department of Field Support, 1 April 2015.

United Nations. *Protection of Civilians—Implementing Guidelines for Military Components of United Nations Peacekeeping Operations*. New York: UN Department of Peacekeeping Operations and Department of Field Support, 13 February 2015.

United Nations. *Report of the Panel on United Nations Peace Operations (A/55/305 - S/2000/809)*. New York: The United Nations, 2000.

United Nations. *Uniting Our Strengths for Peace—Politics Partnership and People: Report of the High-Level Independent Panel on United Nations Peace Operations*. New York: The United Nations, 16 June 2015.

United Nations Department of Peacekeeping Operations and Department of Field Support. Online PoC Training Modules.

United States Agency for International Development. *Civilian-Military Operations Guide*. Washington DC: USAID Office of Military Affairs, 2010.

United States Agency for International Development. *Field Operations Guide for Disaster Assessment and Response*. Washington, DC: USAID Office of U.S. Foreign Disaster Assistance, 2005.

United States Army. Army Techniques Publication (ATP) 3-07.6 *Protection of Civilians*. Washington, DC: Headquarters, Department of the Army, October 2015.

United States Institute of Peace (USIP) and U.S. Army Peacekeeping and Stability Operations Institute (PKSOI). *Guiding Principles for Stabilization and Reconstruction*. Washington, DC: USIP, 2009.

Weir, Erin. *The Last Line of Defense: How Peacekeepers Can Better Protect Civilians*. Washington, DC: Refugees International, February 2010.

Williams, Paul D. *Enhancing Civilian Protection in Peace Operations: Insights from Africa*. Washington, DC: National Defense University Press, September 2010.

Wilmot, Haidi; Ralph Mamiya, Scott Sheeran, and Marc Weller. *Protection of Civilians*. Oxford: Oxford University Press, 2016.

About the PoC Military Reference Guide

The primary author for this revision is Dwight Raymond of the U.S. Army War College's Peacekeeping and Stability Operations Institute (PKSOI). PKSOI encourages the *Protection of Civilians Military Reference Guide's* modification and adaptation to support the individual requirements of other organizations. For more information, please contact Dwight Raymond at allen.d.raymond2.civ@mail.mil.

Acknowledgements

Acknowledgements and deepest thanks are due to the following contributors to the original 2013 version and this revision: Chiyuki Aoi, Paul Armitage, Mark Bowser, Chris Browne, Jennifer Bryson, Marlies Bull, Godfrey Buluma, Michael Chu, Jacqui Coplen, Carlos Alberto Dos Santos Cruz, Stein Ellingsen, Mike Esper, Maureen Farrell, Theodore Feifer, Tammy Fitzgerald, Bill Flavin, Katrina Gehman, Alison Giffen, Aditi Gorur, Whitney Grespin, Shawn Greene, Guy Hammond, Mike Hoffman, Sarah Holewinski, Tori Holt, Tony Icyan, George Katsos, Marla Keenan, Max Kelly, Chiyuki Kozuka, Dave Krall, Kathleen Kuehnast, Daniel Levine, Lisa Löfquist, Muhammad Arif Malik, Tomas Malina, Ralph Mamiya, Kenneth Martin, Bill Martinez, Ryan McCannell, Jenny McAvoy, Greg McNeal, Warren Miska, Jennifer Nevil, Oanh-Nhi Nguyen, Jose Ricardo Vendramin-Nunes, Terry Nunn, Alla Polyakova, Jurgen Prandtner, Aurelie Proust, Mike Rauhut, Jim Rolfe, Robert Schütte, Akikazu Shibasaki, Shalinda Sprehn, Tim Sullivan, Maria Trovato, Catherine Tye, Andrew Viscardo, Paul Williams, Sarah Williamson, and other individuals who prefer not to be identified.

This document is not the official policy of nor endorsed by any of the organizations whose individuals contributed.

